

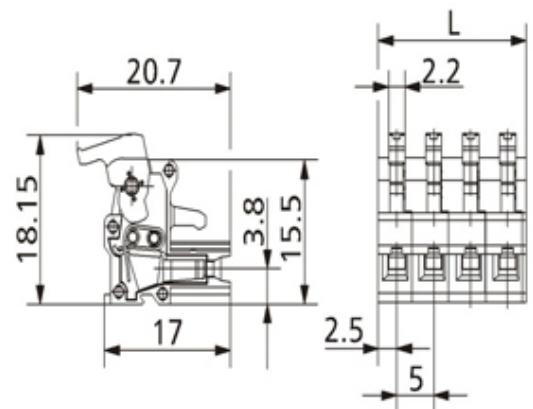

Plug and Socket PCB Terminal Blocks

Range: PCB Terminal Blocks, Connectors and Fuse Holders

Order Code: ASP0451222

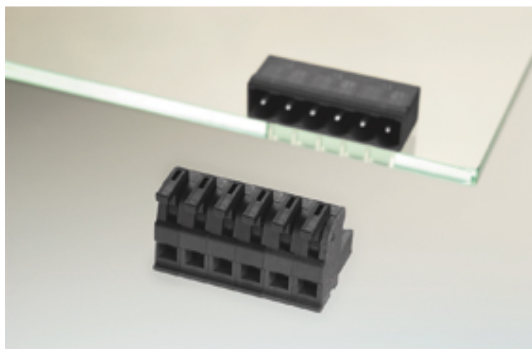

DESCRIPTION

12 Pole vertical spring PCB terminal block 5mm pitch 10A 250V

Subject to technical modification without notice.

Typographical and other errors do not justify claim for damages.

SPECIFICATION

Type	Cable mount - Female plug
Connection Method	Spring - Screwless
Mounting Type	Spring clamp
Orientation	Vertical
Join	End stackable
Pitch (mm)	5
Number of Poles	12
Min Wire Size (Sq mm)	0.08
Max Wire Size (Sq mm)	1
Max Current (A)	10
Max Voltage (V)	250
Height (mm)	18.15
Standard Colour	Black
Width (mm)	20.7
Length (mm)	60
Comments	Pole sizes / no of ways not shown, please contact us for availability
IP Rating	20
Min Temperature Rating °C	16
Min Wire Size AWG	28
Pin Style	Pluggable
Tracking Resistance CTI (v)	400

INDUSTRY ACCREDITATIONS

