

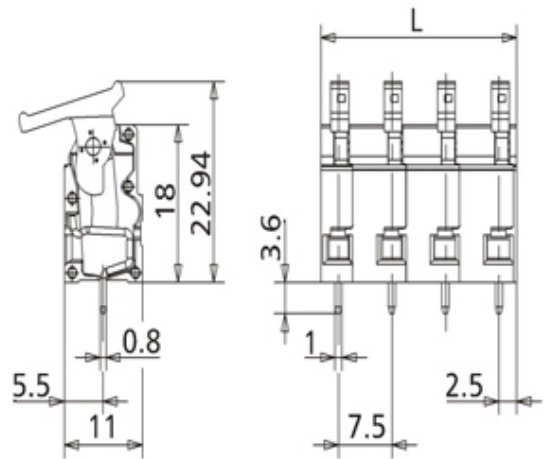

Standard PCB Terminal Blocks

Range: PCB Terminal Blocks, Connectors and Fuse Holders

Part Number: AST0570422

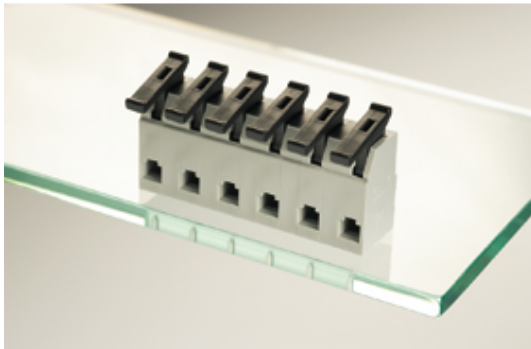

DESCRIPTION

4 Pole horizontal spring PCB terminal block 7.5mm pitch 20A 500V

Subject to technical modification without notice.

Typographical and other errors do not justify claim for damages.

SPECIFICATION

Type	Spring - Screwless
Connection Method	Lever / Tool Less
Mounting Type	Wave - through hole
Orientation	Horizontal
Join	End stackable
Pitch (mm)	7.5
Number of Poles	4
Min Wire Size (Sq mm)	0.08
Max Wire Size (Sq mm)	2.5
Max Current (A)	20
Max Voltage (V)	500
Height (mm)	22.9
Standard Colour	Black
Width (mm)	17.4
Length (mm)	27.5
Solder Pin Length (mm)	3.1
PCB Hole Diameter (mm)	1.4
Comments	Pole sizes / no of ways not shown, please contact us for availability
IP Rating	20
Min Temperature Rating °C	12
Min Wire Size AWG	28
Pin Style	Solderable
Tracking Resistance CTI (v)	600

INDUSTRY ACCREDITATIONS

