

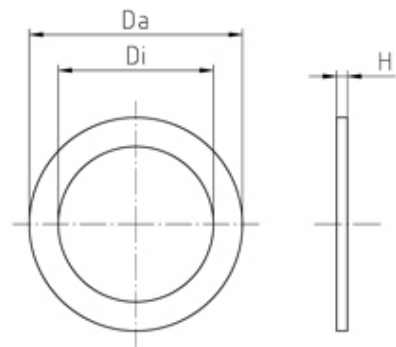

Inserts/Accessories

Range: Cable Glands/Grommets

Part Number: D 336/38



DESCRIPTION

Washer PG36

*Subject to technical modification without notice.
Typographical and other errors do not justify claim for damages.*

SPECIFICATION

Product Type	Standard
Thread Size	PG36
External Diameter (mm)	45
Washer Material	Steel, zinc-plated
Interior Diameter (mm)	38
Comments	assembled in series: 19.5xx, 19.6xx, 23.6xx, 63xx, 63xx UG, 3xx M, 3xxxx, 21.1xx
Height (mm)	0.8