

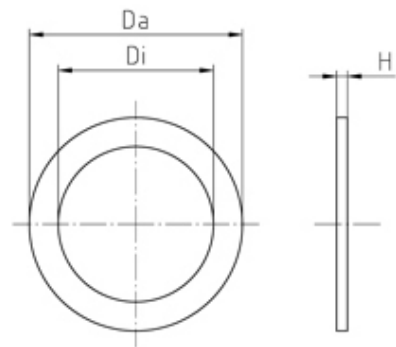

Inserts/Accessories

Range: Cable Glands/Grommets

Part Number: D 316/12



DESCRIPTION

Washer PG16 , material - steel, zinc-plated- Int./Ext Dia. 12/20.5

Subject to technical modification without notice.

Typographical and other errors do not justify claim for damages.

SPECIFICATION

Product Type	Standard
Thread Size	PG16
External Diameter (mm)	20.5
Washer Material	Steel, zinc-plated
Interior Diameter (mm)	12
Comments	assembled in series: 19.5xx, 19.6xx, 23.6xx, 63xx, 63xx UG, 3xx M, 3xxxx, 21.1xx
Height (mm)	0.8