

Nylon PG Cable Glands

Range: Cable Glands/Grommets

Part Number: 28.729 PA

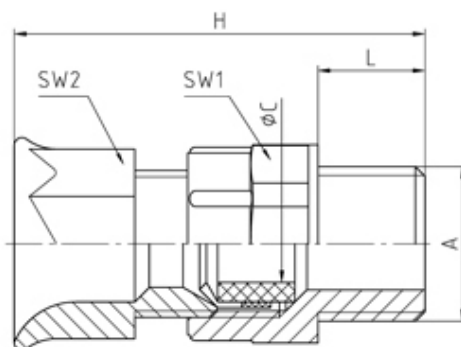

DESCRIPTION

Bell mouth krallen cable gland PA7035 PG29 thread length 11 min/max cable dia 18-24

Subject to technical modification without notice.

Typographical and other errors do not justify claim for damages.

SPECIFICATION

Product Type	Standard
Sealing Ring Material	SBR/NBR
Body Material	Polyamide
Min Temperature Rating °C	-30
Max Temperature Rating °C	100
IP Rating	65
Colour	Light Grey - RAL 7035
Thread Size	PG29
Clamping Range Min (mm)	18
Clamping Range Max (mm)	24
External Connecting Thread Type	PG
Thread Length (mm)	11
Clamping Cage Material	Polyoxymethylene POM (Hostaform C)
Width Across Flat 1 (mm)	42
Width Across Flat 2 (mm)	41
Height (mm)	60
Connecting Thread Size	Pg 29
Additional Material Detail	Body - Polyamide PA6 GF30