

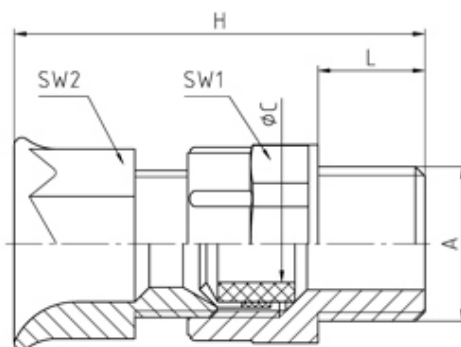

Nylon PG Cable Glands

Range: Cable Glands/Grommets

Part Number: 28.709 PA



DESCRIPTION

Bell mouth krallen cable gland PA7035 PG9 thread length 8 min/max cable dia 6-8

Subject to technical modification without notice.

Typographical and other errors do not justify claim for damages.

SPECIFICATION

Product Type	Standard
Sealing Ring Material	SBR/NBR
Body Material	Polyamide
Min Temperature Rating °C	-30
Max Temperature Rating °C	100
IP Rating	65
Colour	Light Grey - RAL 7035
Thread Size	PG9
Clamping Range Min (mm)	6
Clamping Range Max (mm)	8
External Connecting Thread Type	PG
Thread Length (mm)	8
Clamping Cage Material	Polyoxymethylene POM (Hostaform C)
Width Across Flat 1 (mm)	19
Width Across Flat 2 (mm)	17
Height (mm)	38
Connecting Thread Size	Pg 9
Additional Material Detail	Body - Polyamide PA6 GF30