

Nylon PG Cable Glands

Range: Cable Glands/Grommets

Order Code: 28.707 PA

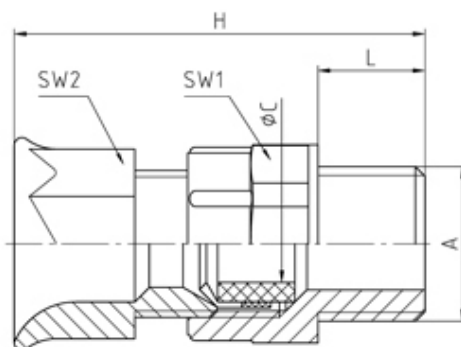

DESCRIPTION

Bell mouth krallen cable gland PA7035 PG7 thread length 8 min/max cable dia 4-6

Subject to technical modification without notice.

Typographical and other errors do not justify claim for damages.

SPECIFICATION

Product Type	Standard
Sealing Ring Material	SBR/NBR
Body Material	Polyamide
Min Temperature Rating °C	-30
Max Temperature Rating °C	100
IP Rating	65
Colour	Light Grey - RAL 7035
Thread Size	PG7
Clamping Range Min (mm)	4
Clamping Range Max (mm)	6
External Connecting Thread Type	PG
Thread Length (mm)	8
Clamping Cage Material	Polyoxymethylene POM (Hostaform C)
Width Across Flat 1 (mm)	15
Width Across Flat 2 (mm)	13
Height (mm)	36
Connecting Thread Size	Pg 7
Additional Material Detail	Body - Polyamide PA6 GF30