

Nylon PG Cable Glands

Range: Cable Glands/Grommets

Order Code: GCG-PPG-PG21-10GL (18210710 T)

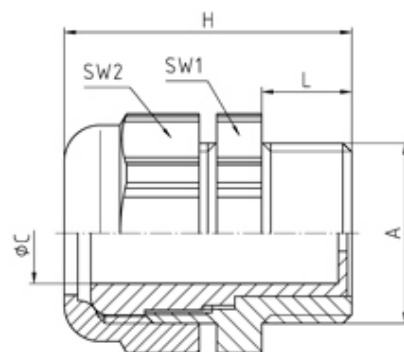

DESCRIPTION

Uni-Dicht cable gland PA7032 PG21 thread length 11 min/max cable dia 7-10.5

Subject to technical modification without notice.

Typographical and other errors do not justify claim for damages.

SPECIFICATION

Product Type	Standard
Body Material	Polyamide
Min Temperature Rating °C	-20
Max Temperature Rating °C	100
IP Rating	68
Colour	Pebble Grey - RAL 7032
Thread Size	PG21
Clamping Range Min (mm)	7
Clamping Range Max (mm)	10.5
External Connecting Thread Type	PG
Thread Length (mm)	11
Sealing Insert	PVC, colour coded
Width Across Flat 1 (mm)	33
Width Across Flat 2 (mm)	33
Height (mm)	40.5
Connecting Thread Size	Pg 21
Additional Material Detail	Body - Polyamide PA6