

Nylon PG Cable Glands

Range: Cable Glands/Grommets

Order Code: GCG-PPG-PG16-9GL (18166595 T)

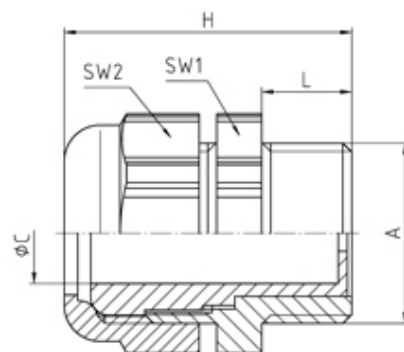

DESCRIPTION

Uni-Dicht cable gland PA7032 PG16 thread length 9.5 min/max cable dia 6.5-9.5

Subject to technical modification without notice.

Typographical and other errors do not justify claim for damages.

SPECIFICATION

Product Type	Standard
Body Material	Polyamide
Min Temperature Rating °C	-20
Max Temperature Rating °C	100
IP Rating	68
Colour	Pebble Grey - RAL 7032
Thread Size	PG16
Clamping Range Min (mm)	6.5
Clamping Range Max (mm)	9.5
External Connecting Thread Type	PG
Thread Length (mm)	9.5
Sealing Insert	PVC, colour coded
Width Across Flat 1 (mm)	27
Width Across Flat 2 (mm)	27
Height (mm)	33
Connecting Thread Size	Pg 16
Additional Material Detail	Body - Polyamide PA6