

Nylon PG Cable Glands

Range: Cable Glands/Grommets

Part Number: 50011P7035/zz

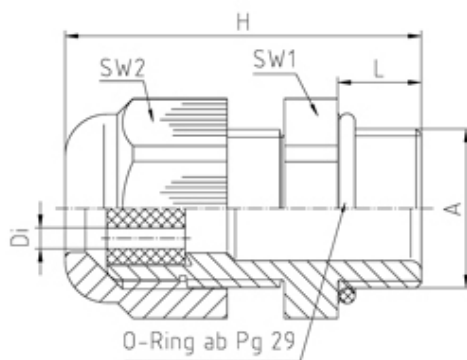

DESCRIPTION

Perfect cable gland PA7035 PG11 with multiple hole sealing insert, see comments. Thread length 8

Subject to technical modification without notice.

Typographical and other errors do not justify claim for damages.

SPECIFICATION

Product Type	Standard
Body Material	Polyamide
Min Temperature Rating °C	-20
Max Temperature Rating °C	100
IP Rating	65
Colour	Light Grey - RAL 7035
Thread Size	PG11
External Connecting Thread Type	PG
Thread Length (mm)	8
Sealing Insert	Evoprene TPE
Comments	please indicate required sealing insert, e.g. 50.009 PA/4x2 sealing inserts - see WJ-D xx/zXz
Width Across Flat 1 (mm)	22
Width Across Flat 2 (mm)	22
Height (mm)	37
Connecting Thread Size	Pg 11
Additional Material Detail	Body - Polyamide PA6 V-2