

Nylon PG Cable Glands

Range: Cable Glands/Grommets

Part Number: 50.021 PA/FL

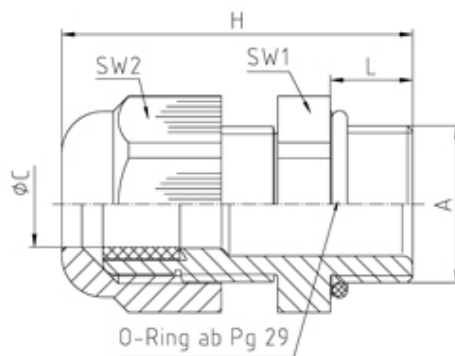

DESCRIPTION

Perfect cable gland PA7035 PG21 thread length 11, min/max cable dia 13-18 Body - Polyamide PA6 V-0

Subject to technical modification without notice.

Typographical and other errors do not justify claim for damages.

SPECIFICATION

Product Type	Standard
Sealing Ring Material	Polychloroprene-Nitrile rubber CR/NBR
Body Material	Polyamide
Min Temperature Rating °C	-20
Max Temperature Rating °C	100
IP Rating	68
Colour	Light Grey - RAL 7035
Thread Size	PG21
Clamping Range Min (mm)	13
Clamping Range Max (mm)	18
External Connecting Thread Type	PG
Thread Length (mm)	11
Glow Wire Resistance Test Temp	960 at 0.8mm wall thickness
Comments	details about test standards see annex/hexagonal locknut of polyamide PA6 V-0 see 2xx PA-FLzzzz
Width Across Flat 1 (mm)	33
Width Across Flat 2 (mm)	33
Height (mm)	47.5
Connecting Thread Size	Pg 21
Additional Material Detail	Body - Polyamide PA6 V-0
Standards	UL514B
Test Standard	UL 514B

INDUSTRY ACCREDITATIONS

