

Nylon PG Cable Glands

Range: Cable Glands/Grommets

Part Number: 50.021 PA/R

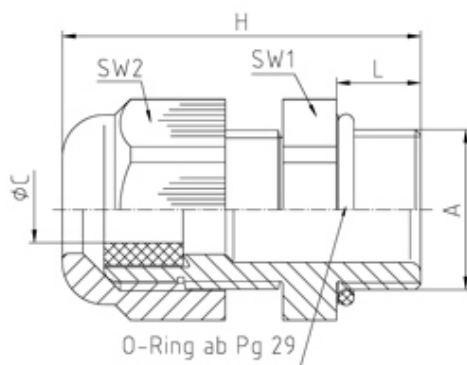

DESCRIPTION

Perfect cable gland with reducer insert PA7001 PG21 thread length 11, min/max cable dia 9-16

Subject to technical modification without notice.

Typographical and other errors do not justify claim for damages.

SPECIFICATION

Product Type	Standard
Sealing Ring Material	Polychloroprene-Nitrile rubber CR/NBR
Body Material	Polyamide
Min Temperature Rating °C	-20
Max Temperature Rating °C	100
IP Rating	68
Colour	Dark Grey - RAL 7001
Thread Size	PG21
Clamping Range Min (mm)	9
Clamping Range Max (mm)	16
External Connecting Thread Type	PG
Thread Length (mm)	11
Comments	details about test standards see annex
Width Across Flat 1 (mm)	33
Width Across Flat 2 (mm)	33
Height (mm)	47.5
Connecting Thread Size	Pg 21
Additional Material Detail	Body - Polyamide PA6 V-2
Standards	UL514B
Test Standard	UL 514B

INDUSTRY ACCREDITATIONS

