

Nylon PG Cable Glands

Range: Cable Glands/Grommets

Part Number: 50.007 PA/R

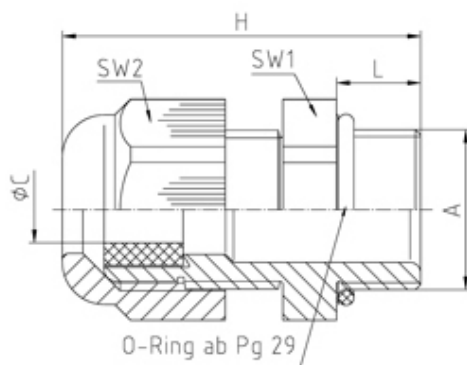

DESCRIPTION

Perfect cable gland with reducer insert PA7001 PG7 thread length 8, min/max cable dia 2-5

Subject to technical modification without notice.

Typographical and other errors do not justify claim for damages.

SPECIFICATION

Product Type	Standard
Sealing Ring Material	Polychloroprene-Nitrile rubber CR/NBR
Body Material	Polyamide
Min Temperature Rating °C	-20
Max Temperature Rating °C	100
IP Rating	68
Colour	Dark Grey - RAL 7001
Thread Size	PG7
Clamping Range Min (mm)	2
Clamping Range Max (mm)	5
External Connecting Thread Type	PG
Thread Length (mm)	8
Comments	details about test standards see annex
Width Across Flat 1 (mm)	15
Width Across Flat 2 (mm)	15
Height (mm)	30.5
Connecting Thread Size	Pg 7
Additional Material Detail	Body - Polyamide PA6 V-2
Standards	UL514B
Test Standard	UL 514B

INDUSTRY ACCREDITATIONS

