

Nylon PG Cable Glands

Range: Cable Glands/Grommets

Part Number: 50.021 PASW15

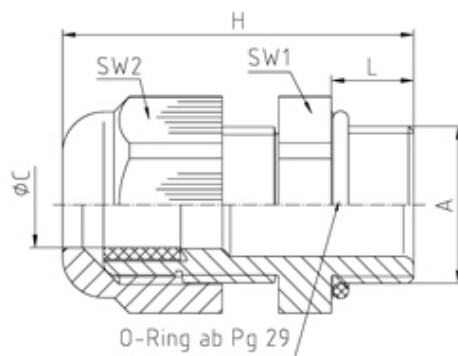

DESCRIPTION

Perfect cable gland long thread PA/SW PG21 thread length 15, min/max cable dia 13-18

Subject to technical modification without notice.

Typographical and other errors do not justify claim for damages.

SPECIFICATION

Product Type	Standard
Sealing Ring Material	Polychloroprene-Nitrile rubber CR/NBR
Body Material	Polyamide
Min Temperature Rating °C	-20
Max Temperature Rating °C	100
IP Rating	68
Colour	Black - RAL 9005
Thread Size	PG21
Clamping Range Min (mm)	13
Clamping Range Max (mm)	18
External Connecting Thread Type	PG
Thread Length (mm)	15
Comments	details about test standards see annex
Width Across Flat 1 (mm)	33
Width Across Flat 2 (mm)	33
Height (mm)	51.5
Connecting Thread Size	Pg 21
Additional Material Detail	Body - Polyamide PA6 V-2
Standards	UL514B
Test Standard	UL 514B

INDUSTRY ACCREDITATIONS

