

# Nylon PG Cable Glands

## Range: Cable Glands/Grommets

Part Number: 50.009 PASW15

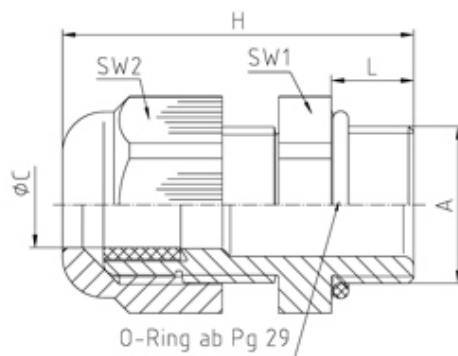

### DESCRIPTION

Perfect cable gland long thread PA/SW PG9 thread length 15, min/max cable dia 4-8

*Subject to technical modification without notice.*

*Typographical and other errors do not justify claim for damages.*

## SPECIFICATION

<b>Product Type</b>	Standard
<b>Sealing Ring Material</b>	Polychloroprene-Nitrile rubber CR/NBR
<b>Body Material</b>	Polyamide
<b>Min Temperature Rating °C</b>	-20
<b>Max Temperature Rating °C</b>	100
<b>IP Rating</b>	68
<b>Colour</b>	Black - RAL 9005
<b>Thread Size</b>	PG9
<b>Clamping Range Min (mm)</b>	4
<b>Clamping Range Max (mm)</b>	8
<b>External Connecting Thread Type</b>	PG
<b>Thread Length (mm)</b>	15
<b>Comments</b>	details about test standards see annex
<b>Width Across Flat 1 (mm)</b>	19
<b>Width Across Flat 2 (mm)</b>	19
<b>Height (mm)</b>	41
<b>Connecting Thread Size</b>	Pg 9
<b>Additional Material Detail</b>	Body - Polyamide PA6 V-2
<b>Standards</b>	UL514B
<b>Test Standard</b>	UL 514B

## INDUSTRY ACCREDITATIONS

