

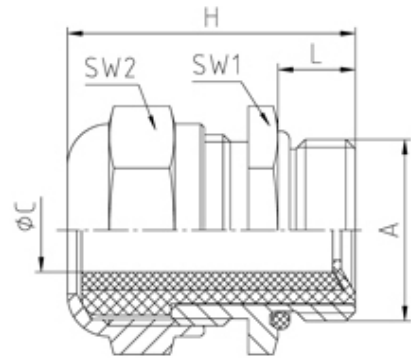

Nickel Plated Brass PG Cable Glands

Range: Cable Glands/Grommets

Order Code: 110906

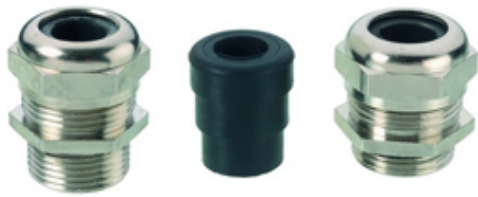

DESCRIPTION

Wadi cable gland PG 9-10 thread length 10, min/max cable dia 5-10 sealing insert material Nitrile rubber

Subject to technical modification without notice.

Typographical and other errors do not justify claim for damages.

SPECIFICATION

Product Type	Standard
Body Material	Nickel Plated Brass
Min Temperature Rating °C	-30
Max Temperature Rating °C	110
IP Rating	65
Thread Size	PG9
Clamping Range Min (mm)	5
Clamping Range Max (mm)	10
External Connecting Thread Type	PG
Thread Length (mm)	10
Sealing Insert	Nitrile rubber
Washer Material	Brass, nickel-plated
Width Across Flat 1 (mm)	18
Width Across Flat 2 (mm)	18
Height (mm)	27.5
Connecting Thread Size	Pg 9
Additional Material Detail	Body - Brass CuZn39Pb3 nickel plated, O-Ring - Nitrile rubber