

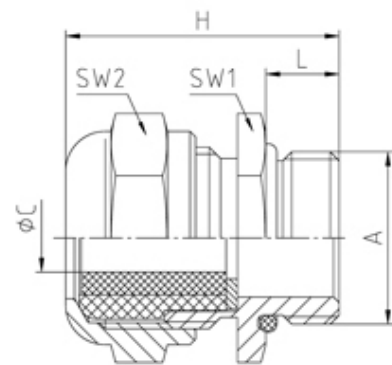

Nickel Plated Brass PG Cable Glands

Range: Cable Glands/Grommets

Order Code: GCG-WTS-G1.0-NP (102913)



DESCRIPTION

Wadi cable gland G 1 thread length 11, min/max cable dia 18-25.5 sealing insert material Polychloroprene-Nitrile rubber CR/NBR

Subject to technical modification without notice.

Typographical and other errors do not justify claim for damages.

SPECIFICATION

Product Type	Standard
Body Material	Nickel Plated Brass
Min Temperature Rating °C	-30
Max Temperature Rating °C	110
IP Rating	65
Thread Size	G 1
Clamping Range Min (mm)	18
Clamping Range Max (mm)	25.5
External Connecting Thread Type	PG
Thread Length (mm)	11
Sealing Insert	Polychloroprene-Nitrile rubber CR/NBR
Washer Material	Brass, nickel-plated
Width Across Flat 1 (mm)	40
Width Across Flat 2 (mm)	40
Height (mm)	36
Connecting Thread Size	G 1
Additional Material Detail	Body - Brass CuZn39Pb3 nickel plated, O-Ring - Nitrile rubber