

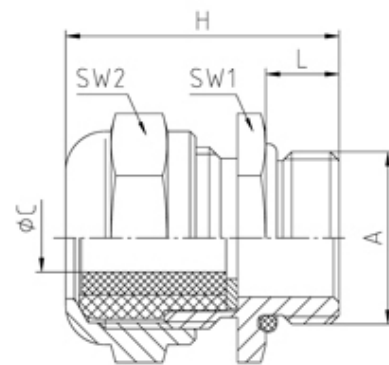

Nickel Plated Brass PG Cable Glands

Range: Cable Glands/Grommets

Order Code: GCG-WPS-PG36-NP (101036)



DESCRIPTION

Wadi cable gland PG 36 thread length 8, min/max cable dia 27-34.5 sealing insert material Polychloroprene-Nitrile rubber CR/NBR

Subject to technical modification without notice.

Typographical and other errors do not justify claim for damages.

SPECIFICATION

Product Type	Standard
Body Material	Nickel Plated Brass
Min Temperature Rating °C	-30
Max Temperature Rating °C	110
IP Rating	65
Thread Size	PG36
Clamping Range Min (mm)	27
Clamping Range Max (mm)	34.5
External Connecting Thread Type	PG
Thread Length (mm)	8
Sealing Insert	Polychloroprene-Nitrile rubber CR/NBR
Washer Material	Brass, nickel-plated
Width Across Flat 1 (mm)	50
Width Across Flat 2 (mm)	50
Height (mm)	35
Connecting Thread Size	Pg 36
Additional Material Detail	Body - Brass CuZn39Pb3 nickel plated, O-Ring - Nitrile rubber