

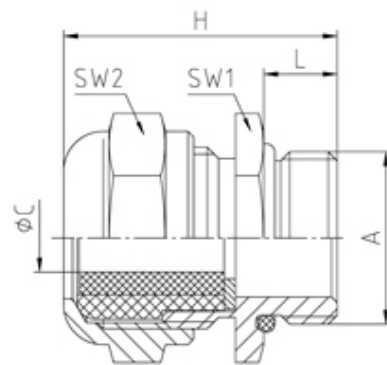

Nickel Plated Brass PG Cable Glands

Range: Cable Glands/Grommets

Order Code: GCG-WPS-PG7-NP (101007)



DESCRIPTION

Wadi cable gland PG7 thread length 6, min/max cable dia 4-6.5 sealing insert material Polychloroprene-Nitrile rubber CR/NBR

Subject to technical modification without notice.

Typographical and other errors do not justify claim for damages.

SPECIFICATION

Product Type	Standard
Body Material	Nickel Plated Brass
Min Temperature Rating °C	-30
Max Temperature Rating °C	110
IP Rating	65
Thread Size	PG7
Clamping Range Min (mm)	4
Clamping Range Max (mm)	6.5
External Connecting Thread Type	PG
Thread Length (mm)	6
Sealing Insert	Polychloroprene-Nitrile rubber CR/NBR
Washer Material	Brass, nickel-plated
Width Across Flat 1 (mm)	14
Width Across Flat 2 (mm)	14
Height (mm)	21.5
Connecting Thread Size	Pg 7
Additional Material Detail	Body - Brass CuZn39Pb3 nickel plated, O-Ring - Nitrile rubber