

Nickel Plated Brass PG Cable Glands

Range: Cable Glands/Grommets

Part Number: 50.009/EMV

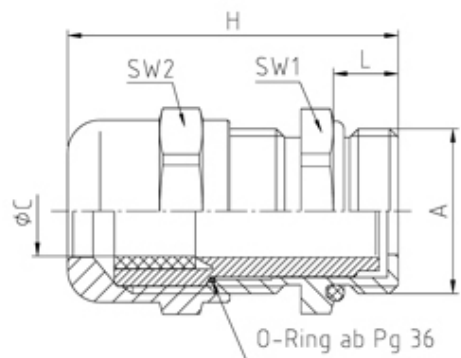

DESCRIPTION

Perfect cable gland EMV PG 9 thread length 6, min/max cable dia 4-8

CABLE GLANDS/GROMMETS FEATURES

- PG Nickel Plated Brass
- Easy to install
- 50.0xx range offers protection against twisting and also offers integrated anchorage
- EMC Versions available

Subject to technical modification without notice.

Typographical and other errors do not justify claim for damages.

SPECIFICATION

Product Type	EMV/EMC
Sealing Ring Material	Polychloroprene-Nitrile rubber CR/NBR
Body Material	Nickel Plated Brass
Min Temperature Rating °C	-20
Max Temperature Rating °C	100
IP Rating	68
Thread Size	PG9
Clamping Range Min (mm)	4
Clamping Range Max (mm)	8
Lamellar Insert Material	Polyamide PA6 V-2
External Connecting Thread Type	PG
Thread Length (mm)	6
Width Across Flat 1 (mm)	17
Width Across Flat 2 (mm)	17
Height (mm)	29
Connecting Thread Size	Pg 9
Additional Material Detail	Body - Brass CuZn39Pb3 nickel plated, O-Ring - Nitrile rubber