

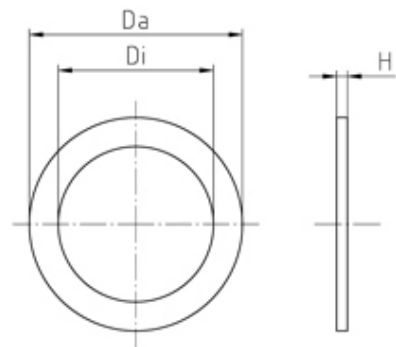

Inserts/Accessories

Range: Cable Glands/Grommets

Part Number: DM340/33.0



DESCRIPTION

Washer, material - steel, zinc-plated Internal dia Ext. Dia 38

Subject to technical modification without notice.

Typographical and other errors do not justify claim for damages.

SPECIFICATION

Product Type	Standard
Hole Diameter (mm)	33
Thread Size	M40
External Diameter (mm)	38
Washer Material	Steel, zinc-plated
Comments	assembled in series: 63MxxUG, 08xxUG, 21.7xxM, 21.7xxPAzzzz
Height (mm)	0.8