

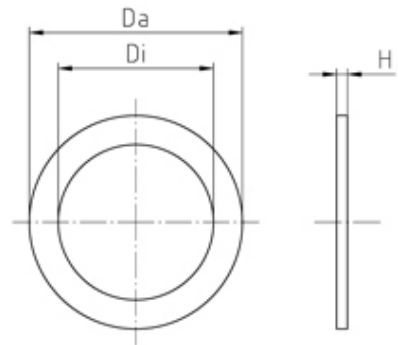

Inserts/Accessories

Range: Cable Glands/Grommets

Part Number: 3M40-D



DESCRIPTION

Sealing ring, for connecting thread, material - Polyethylene PE-LD Internal dia 40 Ext. Dia 45

*Subject to technical modification without notice.
Typographical and other errors do not justify claim for damages.*

SPECIFICATION

Product Type	Standard
Min Temperature Rating °C	-30
Max Temperature Rating °C	90
Thread Size	M40
External Diameter (mm)	45
Interior Diameter (mm)	40
Sealing Ring for Connection Thread	Polyethylene PE-LD
Comments	assembled o-ring enables higher protection grades
Height (mm)	2