

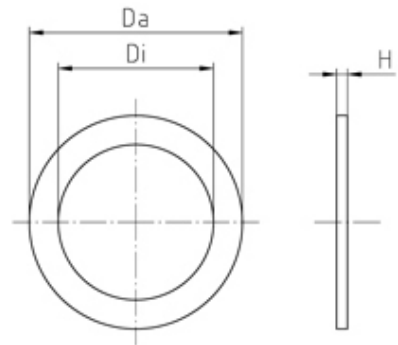

Inserts/Accessories

Range: Cable Glands/Grommets

Part Number: FD-M20



DESCRIPTION

Sealing ring, for connecting thread, material - Chloroprene rubber CR Internal dia 18.2 Ext. Dia 23.5

*Subject to technical modification without notice.
Typographical and other errors do not justify claim for damages.*

SPECIFICATION

Product Type	Standard
Min Temperature Rating °C	-30
Max Temperature Rating °C	100
Thread Size	M20
External Diameter (mm)	23.5
Interior Diameter (mm)	18.2
Sealing Ring for Connection Thread	Chloroprene rubber CR
Comments	assembled o-ring enables higher protection grades
Height (mm)	1