

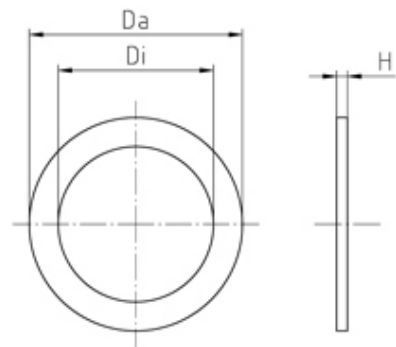

Inserts/Accessories

Range: Cable Glands/Grommets

Part Number: FD-M16



DESCRIPTION

Sealing ring, for connecting thread, material - Chloroprene rubber CR Internal dia 14.2 Ext. Dia 19.5

Subject to technical modification without notice.

Typographical and other errors do not justify claim for damages.

SPECIFICATION

Product Type	Standard
Min Temperature Rating °C	-30
Max Temperature Rating °C	100
Thread Size	M16
External Diameter (mm)	19.5
Interior Diameter (mm)	14.2
Sealing Ring for Connection Thread	Chloroprene rubber CR
Comments	assembled o-ring enables higher protection grades
Height (mm)	1