

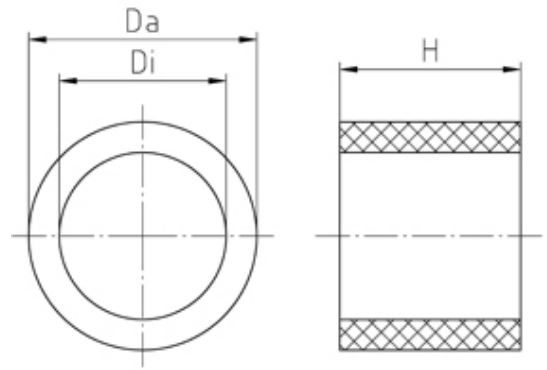

Inserts/Accessories

Range: Cable Glands/Grommets

Part Number: WJ-D 7



DESCRIPTION

Sealing ring, material - Polychloroprene-Nitrile rubber CR/NBR Internal dia 6.8 Ext. Dia 8.5

Subject to technical modification without notice.

Typographical and other errors do not justify claim for damages.

SPECIFICATION

Product Type	Standard
Sealing Ring Material	Polychloroprene-Nitrile rubber CR/NBR
Min Temperature Rating °C	-20
Max Temperature Rating °C	100
Thread Size	PG7
External Diameter (mm)	8.5
Interior Diameter (mm)	6.8
Comments	Table 1 - assembled in PERFECT series: 50.6xx M, 50.6xx/xx M, 50.6xx M/V, 50.6xx M/EMV, 50.6xx Pazzz
Height (mm)	6.5