



# Inserts/Accessories

## Range: Cable Glands/Grommets

Part Number: WJ-DM 12-1

---

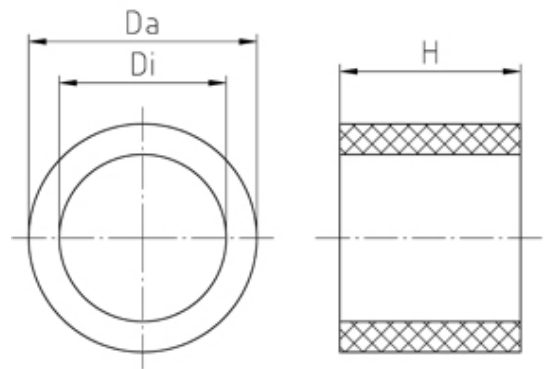

---

### DESCRIPTION

Sealing ring, material - Polychloroprene-Nitrile rubber CR/NBR Internal dia 6 Ext. Dia 8.2

*Subject to technical modification without notice.*

*Typographical and other errors do not justify claim for damages.*

## SPECIFICATION

<b>Product Type</b>	Standard
<b>Sealing Ring Material</b>	Polychloroprene-Nitrile rubber CR/NBR
<b>Min Temperature Rating °C</b>	-20
<b>Max Temperature Rating °C</b>	100
<b>Thread Size</b>	M12
<b>External Diameter (mm)</b>	8.2
<b>Interior Diameter (mm)</b>	6
<b>Comments</b>	Table 1 - assembled in PERFECT series: 50.6xx M, 50.6xx/xx M, 50.6xx M/V, 50.6xx M/EMV, 50.6xx Pazzz
<b>Height (mm)</b>	6.5