

Elbow Glands

Range: Cable Glands/Grommets

Order Code: GCG-EMM-M16-GL (21.716PA7035)

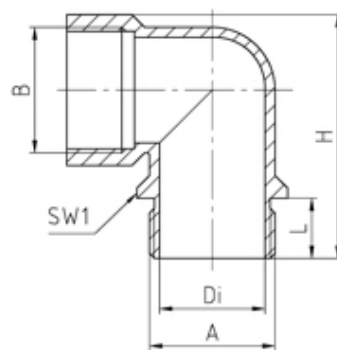

DESCRIPTION

Elbow cable gland PA7035 M16 thread length 12 min/max cable dia 5-9

Subject to technical modification without notice.

Typographical and other errors do not justify claim for damages.

SPECIFICATION

Product Type	Standard
Sealing Ring Material	SBR/NBR, multiple perforation
Body Material	Polyamide
Min Temperature Rating °C	-20
Max Temperature Rating °C	100
Colour	Light Grey - RAL 7035
Thread Size	M16
Clamping Range Min (mm)	5
Clamping Range Max (mm)	9
Thread Length (mm)	12
Width Across Flat 2 (mm)	16
Height (mm)	38
Connecting Thread Size	M16x1.5
Additional Material Detail	Body - Polyamide PA6 GF30, Washers - Steel, zinc-plated