



5 Everitt Close,
Denington Industrial Estate,
Wellingborough, Northants, NN8 2QE
Tel: +44 (0)1933 234400
Fax: +44 (0)1933 234411
Email: sales@hylec-apl.com
www.hylec-apl.com
www.hylec-halo.com



MAKING THE RIGHT CONNECTIONS

hylec

MAKING THE RIGHT CONNECTIONS

PRODUCT CATALOGUE - EDITION 5

PRODUCT CATALOGUE
EDITION 5



ENCLOSURES

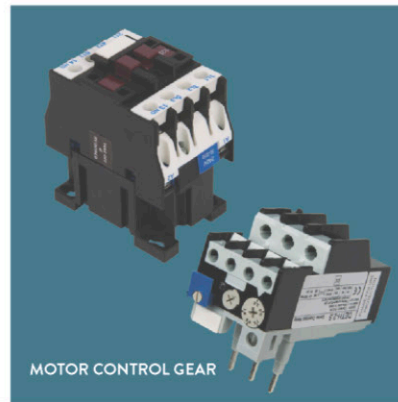

MOTOR CONTROL GEAR



CONTROL STATIONS



PCB TERMINAL BLOCKS
AND FUSE HOLDERS



ENCLOSED,
NON-REVERSING
DOL AC MOTOR STARTERS



CABLE GLANDS



IN-LINE JUNCTION BOXES



CABLE GLANDS



IP67 DE ENCLOSURES

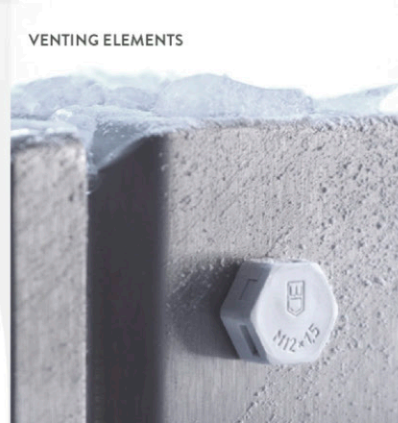

VENTING ELEMENTS



WEATHERPROOF



ENCLOSURES



HYLEC-APL SPECIALISES IN THE MANUFACTURE AND SUPPLY OF ELECTRICAL COMPONENTS - INCLUDING UNIQUE WEATHERPROOF CONNECTORS, CABLE GLANDS, ENCLOSURES AND CONTROL COMPONENTS.

In conjunction with our manufacturing company, DE Controls, we are always working to enhance the range of products we supply to meet the increasing need of our customers.

This catalogue includes many of our new products including the Debox SL, Steel and Stainless Steel Door Enclosures, Isolator Switches, Kwik Lever Connectors, Miniature Tee Plug and Sockets, and our range of PCB Terminal Blocks, Fuse Holders, Switches, PCB Enclosure and Rail Supports - we hope you find these useful additions to our range.

Delivering service, quality and real value for money is our priority.

STOCK

We maintain a large UK stock profile at our Northamptonshire Head Office, offering enhanced product availability to our customers.

TECHNICAL

Our sales team support your choice with a wealth of product knowledge and application experience.

QUALITY & SERVICE

Our company holds ISO 9001:2008 and our products have internationally recognised industrial safety approvals.

INDEX

A	ABS DOOR ENCLOSURES - IP65, IK08	14	N	NYLON PERFECT METRIC IP68 CABLE GLANDS INC. KWIK FIX AND VENTING ELEMENTS	34 - 37
	ABS ENCLOSURES - IP65	9		NYLON PERFECT METRIC IP68 RAILWAY CERTIFIED CABLE GLANDS PA6 V0	38
	ALUMINIUM/STEEL DESKTOP INSTRUMENT CASES	20		NYLON PERFECT PG IP68 CABLE GLANDS	44 - 45
	AUXILIARY CONTACT AND MECHANICAL INTERLOCK MODULE	98 - 99		NYLON PG GLAND ACCESSORIES AND LOCKNUTS	46 - 47
C	CABLE MOUNTING PLUGGABLE (FEMALE) PCB TERMINAL BLOCKS	170 - 192		NYLON PILLAR TERMINAL BLOCKS	82 - 83
	CONTROL EQUIPMENT - HVAC	102 - 103	P	PANEL HEATERS	104 - 105
	CONTROL STATIONS	30 - 31		PCB ENCLOSURES AND RAIL SUPPORTS	200 - 206
	CYLINDRICAL FUSE HOLDERS	193		PCB TERMINAL BLOCKS	106 - 192
D	DE ENCLOSURES WITH HOLE - IP67	24 - 27		PIN HEADER (MALE) - DOUBLE DECKER PCB	167 - 169
	DE ENCLOSURES WITHOUT HOLE - IP67	21 - 23		PIN HEADER (MALE) - SINGLE ROW PCB	149 - 166
	DEBOX IP20	8		POLYPROPYLENE AND NYLON PILLAR TERMINAL BLOCKS	80 - 81
	DEC SERIES 3 POLE CONTRACTORS (AC3)	95	R	RAILWAY CERTIFIED IP68 CABLE GLANDS	38 & 207
	DIE CAST ENCLOSURES - IP68	10		RAISING CLAMP - DOUBLE DECKER PCB	139 - 141
E	ENCLOSED, NON-REVERSING DOL AC MOTOR STARTERS, IP65	94		RAISING CLAMP - SINGLE ROW	118 - 138
	ENCLOSURES/JUNCTION BOXES - IP66, IK08	11		RAISING CLAMP - TRIPLE DECKER PCB	142
F	FUSED PILLAR TERMINAL BLOCKS	84 - 85	S	SCREW TO TAB TERMINAL BLOCKS	86 - 89
G	GEL FILLED CONNECTORS - IP68	77		SCREWLESS - PUSH WIRE	143 - 148
H	HAND HELD ABS INSTRUMENT CASES	16 - 19		STAINLESS STEEL PERFECT METRIC IP68 CABLE GLANDS AND LOCKNUTS	58
I	ISOLATOR SWITCHES IP67	32 - 33		STAINLESS STEEL PG CABLE GLANDS AND LOCKNUTS	59
M	MINIATURE MICROSWITCHES V3	195 - 197		STEATITE HIGH TEMPERATURE TERMINAL BLOCKS	78 - 79
N	NICKEL PLATED BRASS METRIC IP68 ACCESSORIES AND LOCKNUTS	51 - 53		STAINLESS STEEL DOOR ENCLOSURES -IP66, IK10	13
	NICKEL PLATED BRASS METRIC IP68 ATEX GLANDS	50		STEEL DOOR ENCLOSURES - IP66, IK10	12
	NICKEL PLATED BRASS PERFECT IP68 PG CABLE GLANDS	54 - 55		SUBMINATURE MICROSWITCHES V4	194
	NICKEL PLATED BRASS PERFECT METRIC CABLE GLANDS	48 - 49		SWITCHES AND PILOT LAMPS - 22MM	28 - 29
	NICKEL PLATED BRASS PG IP68 ACCESSORIES AND LOCKNUTS	56 - 57	T	TACT SWITCHES	199
	NYLON METRIC AND PG IP68 TEE GLANDS	60 - 61		TEEBLOCK	72 - 73
	NYLON METRIC GLAND ACCESSORIES AND LOCKNUTS	40 - 43		TEEBOX	68 - 71
	NYLON PERFECT METRIC IP66 ATEX GLANDS	39		TEEDRUM	74 - 75
				TEEPLUGS	64 - 67
				TEETUBE - IP68	62 - 63
				TERMINAL BOXES	90 - 91
				THERMAL OVERLOAD RELAYS DETH SERIES	96 - 97
				THROUGH HOLE MOUNTING/WIRE PROTECTED - PCB TERMINAL BLOCKS	106 - 117
				TOP MOUNTING ENCLOSURES AND FILTER FANS	100 - 101
			U	ULTRA MINIATURE AND INDUSTRIAL MICROSWITCHES	198
			W	WEATHERPROOF RANGE ACCESSORIES	76



MAKING THE RIGHT CONNECTIONS

NEW PRODUCTS

QUICK, HASSLE FREE ASSEMBLY

DEBOX S AND SL
Page 8

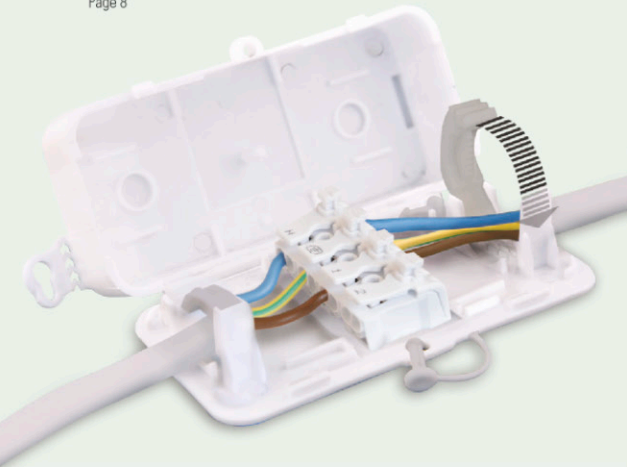

IP68 DIE CAST ENCLOSURES
Page 10



IP66, IK08 ENCLOSURES/JUNCTION BOXES
Page 11



ISOLATOR SWITCHES
Page 32-33



CABLE GLANDS
Page 34-61



VENTING ELEMENTS
Page 34



XDRY
Page 70



PLUG AND SOCKET MICRO-CONNECTOR TH381
Page 15



GEL FILLED CONNECTORS
Page 77



STEATITE HIGH TEMPERATURE TERMINAL BLOCKS
Page 78



STEEL AND STAINLESS STEEL DOOR ENCLOSURES
Page 12-13



ENCLOSED, NON-REVERSING DOLAC MOTOR STARTERS, IP65
Page 94

THERMAL OVERLOAD RELAYS
Page 96



DEC SERIES 3 POLE CONTACTORS
Page 95



KWIK LEVER CONNECTORS
Page 93

KWIK SNAP
Page 80

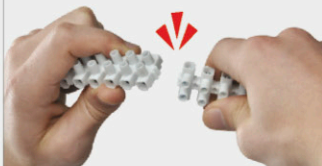

PCB TERMINAL BLOCKS
Page 106-192



IP65 ABS DOOR ENCLOSURES
Page 14



FUSE HOLDERS
Page 193



MAKING THE RIGHT CONNECTIONS

ENCLOSURES



- 8 DEBOX IP20
- 9 IP65 ABS ENCLOSURES
- 10 IP68 DIE CAST ENCLOSURES
- 11 IP66, IK08 ENCLOSURES/JUNCTION BOXES
- 12 IP66, IK10 STEEL DOOR ENCLOSURES
- 13 IP66, IK10 STAINLESS STEEL DOOR ENCLOSURES
- 14 IP65, IK08 ABS DOOR ENCLOSURES
- 16 - 19 HAND HELD ABS INSTRUMENT CASES
RETEX - SERIES 31, 32 & 33
- 20 ALUMINIUM/STEEL
DESKTOP INSTRUMENT CASES
RETEX SERIES 110 & ABOX
- 21 - 23 IP67 DE ENCLOSURES WITHOUT HOLE
- 24 - 27 IP67 DE ENCLOSURES WITH HOLE
- 26 - 27 ENCLOSURE ACCESSORIES



CONTROL STATIONS & ISOLATOR SWITCHES

- 28 - 29 22MM SWITCHES AND PILOT LAMPS
- 30 - 31 CONTROL STATIONS
- 31 CONTROL STATIONS ACCESSORIES
- 32 - 33 IP67 ISOLATOR SWITCHES

CABLE GLANDS

- 34 - 37 NYLON PERFECT METRIC IP68 CABLE GLANDS INC. KWIK FIX AND VENTING ELEMENTS
- 38 NYLON PERFECT METRIC IP68 RAILWAY CERTIFIED CABLE GLANDS PA6 V0
- 39 NYLON PERFECT METRIC IP66 ATEX GLANDS
- 40 - 43 NYLON METRIC GLAND ACCESSORIES AND LOCKNUTS
- 44 - 45 NYLON PERFECT PG IP68 CABLE GLANDS
- 46 - 47 NYLON PG GLAND ACCESSORIES AND LOCKNUTS
- 48 - 49 NICKEL PLATED BRASS PERFECT METRIC CABLE GLANDS
- 50 NICKEL PLATED BRASS METRIC IP68 ATEX GLANDS
- 51 - 53 NICKEL PLATED BRASS METRIC IP68 ACCESSORIES AND LOCKNUTS
- 54 - 55 NICKEL PLATED BRASS PERFECT IP68 PG CABLE GLANDS
- 56 - 57 NICKEL PLATED BRASS PG IP68 ACCESSORIES AND LOCKNUTS
- 58 STAINLESS STEEL PERFECT METRIC IP68 CABLE GLANDS AND LOCKNUTS
- 59 STAINLESS STEEL PG CABLE GLANDS AND LOCKNUTS
- 60 - 61 NYLON METRIC AND PG IP68 TEE GLANDS



WEATHERPROOF

- 62 - 63 IP68 TEETUBE
- 64 - 67 TEEPLUGS
- 68 - 71 TEEBOX
- 72 - 73 TEEBLOCK
- 74 - 75 TEEDRUM
- 76 WEATHERPROOF RANGE ACCESSORIES
- 77 IP68 GEL FILLED CONNECTORS



PRODUCTS AVAILABLE FROM:



EMECH

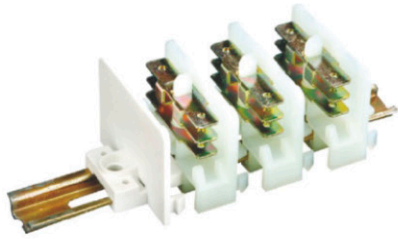

78 - 79 STEATITE HIGH TEMPERATURE TERMINAL BLOCKS

80 - 81 POLYPROPYLENE AND NYLON PILLAR TERMINAL BLOCKS

82 - 83 NYLON PILLAR TERMINAL BLOCKS

84 - 85 FUSED PILLAR TERMINAL BLOCKS

86 - 89 SCREW TO TAB TERMINAL BLOCKS

90 - 91 TERMINAL BOXES

92 KWIK WIRE CONNECTORS

93 KWIK LEVER CONNECTORS

MOTOR CONTROL GEAR

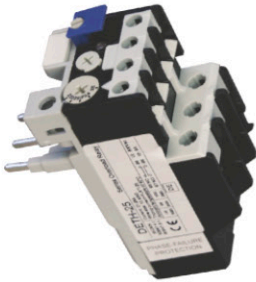

94 ENCLOSED, NON REVERSING, DOLAS MOTOR STARTERS, IP65

95 DEC SERIES 3 POLE CONTRACTORS (AC3)

96 - 97 THERMAL OVERLOAD RELAYS DETH SERIES

98 - 99 AUXILIARY CONTACT AND MECHANICAL INTERLOCK MODULE



HVAC

100 - 101 TOP MOUNTING ENCLOSURES AND FILTER FANS

102 - 103 CONTROL EQUIPMENT

104 - 105 PANEL HEATERS

PCB TERMINAL BLOCKS

106 - 117 THROUGH HOLE MOUNTING/WIRE PROTECTED

118 - 138 RAISING CLAMP - SINGLE ROW

139 - 141 RAISING CLAMP - DOUBLE DECKER PCB

142 RAISING CLAMP - TRIPLE DECKER PCB

143 - 148 SCREWLESS - PUSH WIRE

149 - 166 PIN HEADER (MALE) - SINGLE ROW PCB HEADER

167 - 169 PIN HEADER (MALE) - DOUBLE DECKER PCB HEADER

170 - 192 CABLE MOUNTING - PLUGGABLE (FEMALE)





FUSE HOLDERS

193 CYLINDRICAL & SEMI ENCLOSED



SWITCHES

194 V4 SUBMINATURE MICROSWITCHES

195 - 196 V3 MINATURE MICROSWITCHES

198 ULTRA MINIATURE & INDUSTRIAL MICROSWITCHES

199 TACT SWITCHES



PCB ENCLOSURES AND RAIL SUPPORT

200 - 205 PCB ENCLOSURES AND RAIL SUPPORT

206 HOLE PUNCH AND DIN RAIL SUPPORTS



ADDITIONAL PRODUCTS AND REFERENCE

207 RAILWAY CERTIFIED IP68 CABLE GLANDS

208 RAL COLOUR CHART

2011 INDEX

PRODUCTS AVAILABLE FROM:





Ⓜ Maintenance Free	✗	✓	✓
Screwless Cable Clamps	✓	✓	✓
Screwless Cable Connection	✗	✓	✓
Connectors Included	✓	✓	✓
Click-Close Box	✓	✓	✓
Locking Clip (& Spare)	✓	✓	✓
Fold-Out Fixing Lugs	✓	✓	✓
® Registered Design	✓	✓	✓
No. Of Poles	4	4	5
Amps	24	16	32

debox S debox SL debox SL2

DEBOX - A Range of innovative junction boxes with registered design features which speed up assembly without compromising quality. The range is safe, fast, reliable and is also supplied complete with a 4 Pole connector block (Debox S and SL) or 5x3 Pole connector blocks (Debox SL2). Debox S and SL are capable of accommodating 2, 3 and 4 conductors in round and flat profile cable while Debox SL2 is capable of accommodating 2,3,4 and 5 conductors in round and flat profile cable for ring main lighting, LED lighting or power.

Features:

- Manufactured from Polypropylene material, UL94-V0.
- Supplied complete with VDE approved 4 pole screw terminal block (Debox S), 4 pole screwless terminal block (Debox SL) or 5x3 Pole screwless terminal blocks (Debox SL2).
- Tool-less assembly (Debox SL and SL2).
- Virtually tool-less assembly (Debox S includes screw terminal block).
- Suitable for use with screwless terminals, KwikWire commoning terminals or IDC connectors.
- Can accommodate flat or round profile cables saves multiple inventory.
- No additional purchase required (eg terminal block).
- Saves time.
- Saves money.
- Operating Temperature -10° c to +65° C.
- EN60670 22 (Pull test)**
- Conforms to EN60598-1 (Glow wire test). Spare Butterfly Clip included.

DEBOX SL2 * - NEW 100% SCREWLESS TERMINAL BLOCK

Product Code	Colour	H (mm)	W (mm)	L (mm)	Included Terminal Block	Terminal Body Material	Terminal Insert Material	Max Conductor Size (mm ²)	Maximum Current (A)	Temp Rating
DEKSB-004/5	White	35	47	107	5x3 pole	Polypropylene	Steel	4	32	-20°C to +85°C

* MF applied.

DEBOX SL * - 100% SCREWLESS TERMINAL BLOCK

Product Code	Colour	H (mm)	W (mm)	L (mm)	Included Terminal Block	Terminal Body Material	Terminal Insert Material	Conductor Size (mm ²)		Maximum Current (A)	Temp Rating
								Min.	Max.		
DEKSB-003	White	28.5	50	97	1x4 pole screwless	Polypropylene	Steel	0.5	2.5	16	-20°C to +85°C

* MF applied.

DEBOX S

Product Code	Colour	H (mm)	W (mm)	L (mm)	Included Terminal Block	Terminal Body Material	Terminal Insert Material	Max Conductor Size (mm ²)	Maximum Current (A)	Temp Rating
DEKSB-002	White	28.5	50	97	1x4 pole	Polypropylene	Steel	4	24	-20°C to +85°C

** Debox S, SL and SL2 Comply to EN60670-22 (Pull test)

IP65 ABS ENCLOSURES

SERIES 70

ABS enclosure, screw fit assembly, suitable for housing electronics for a variety of applications within the industrial, electronics and office automation industries. PCB's can be assembled into all bases and most lids via moulded bosses and an optional EPDM gasket is available to improve sealing to IP65. Colour coded enclosure mounting feet option is also available.



Features:

- General purpose high impact enclosure.
- Tough ABS material with temperature range up to +85°C.
- Suitable for a variety of applications.
- IP65 rating can be achieved by use of the optional gasket.
- IP60 rating for standard enclosure
- Optional colour coded mounting feet available.



STEEL MOUNTING PLATES

Product Code	IP Rating	Colour	Enclosure Material	H (mm)	W (mm)	D (mm)	Temp Rating	Description	Comments	
33070001	See comments	Grey RAL 7035	ABS	90	55	25	0°C to +85°C	Screw fit assembly ABS enclosure. PCB's can be assembled into all bases and most lids via moulded bosses and colour coded mounting feet are also available.	IP Rating can be increased to IP65 by fitting the EPDM gasket seal part number 33070041. IP60 rating for standard enclosure.	
33070002				90	55	40	0°C to +85°C		IP Rating can be increased to IP65 by fitting the EPDM gasket seal part number 33070042. IP60 rating for standard enclosure.	
33070004				110	85	35	0°C to +85°C		IP Rating can be increased to IP65 by fitting the EPDM gasket seal part number 33070043. IP60 rating for standard enclosure.	
33070007				127	75	30	0°C to +85°C		IP Rating can be increased to IP65 by fitting the EPDM gasket seal part number 33070044. IP60 rating for standard enclosure.	
33070008				127	75	45	0°C to +85°C		IP Rating can be increased to IP65 by fitting the EPDM gasket seal part number 33070045. IP60 rating for standard enclosure.	
33070011				145	90	45	0°C to +85°C		IP Rating can be increased to IP65 by fitting the EPDM gasket seal part number 33070046. IP60 rating for standard enclosure.	
33070014				190	120	60	0°C to +85°C		IP Rating can be increased to IP65 by fitting the EPDM gasket seal part number 33070047. IP60 rating for standard enclosure.	
33070016		220		145	50	0°C to +85°C	IP Rating can be increased to IP65 by fitting the EPDM gasket seal part number 33070048. IP60 rating for standard enclosure.			
33070017		220		145	80	0°C to +85°C	IP Rating can be increased to IP65 by fitting the EPDM gasket seal part number 33070049. IP60 rating for standard enclosure.			
33070201		Black RAL 9004			90	55	25		0°C to +85°C	IP Rating can be increased to IP65 by fitting the EPDM gasket seal part number 33070050. IP60 rating for standard enclosure.
33070202					90	55	40		0°C to +85°C	IP Rating can be increased to IP65 by fitting the EPDM gasket seal part number 33070051. IP60 rating for standard enclosure.
33070204					110	85	35		0°C to +85°C	IP Rating can be increased to IP65 by fitting the EPDM gasket seal part number 33070052. IP60 rating for standard enclosure.
33070207					127	75	30		0°C to +85°C	IP Rating can be increased to IP65 by fitting the EPDM gasket seal part number 33070053. IP60 rating for standard enclosure.
33070208					127	75	45		0°C to +85°C	IP Rating can be increased to IP65 by fitting the EPDM gasket seal part number 33070054. IP60 rating for standard enclosure.
33070211					145	90	45		0°C to +85°C	IP Rating can be increased to IP65 by fitting the EPDM gasket seal part number 33070055. IP60 rating for standard enclosure.
33070214					190	120	60		0°C to +85°C	IP Rating can be increased to IP65 by fitting the EPDM gasket seal part number 33070056. IP60 rating for standard enclosure.
33070216					220	145	50		0°C to +85°C	IP Rating can be increased to IP65 by fitting the EPDM gasket seal part number 33070057. IP60 rating for standard enclosure.
33070217	220		145		80	0°C to +85°C	IP Rating can be increased to IP65 by fitting the EPDM gasket seal part number 33070058. IP60 rating for standard enclosure.			

SERIES 70 ACCESSORIES

Product Code	Enclosure Material	Temp Rating	Description	Comments
33070041	EPDM	0°C to +85°C	Gasket	Suitable for Enclosure product 33070001 & 33070002
33070042		0°C to +85°C		Suitable for Enclosure product 33070004
33070043		0°C to +85°C		Suitable for Enclosure product 33070007 & 33070008
33070044		0°C to +85°C		Suitable for Enclosure product 33070011
33070045		0°C to +85°C		Suitable for Enclosure product 33070014
33070046		0°C to +85°C		Suitable for Enclosure product 33070016
33070200	ABS	0°C to +85°C	Light Grey mounting feet	Suitable for Enclosure product 33070001 to 33070017
33070300		0°C to +85°C	Black mounting feet	

IP68 DIE CAST ENCLOSURES

Features:

- High impact diecast products.
- Corrosion resistant Aluminium alloy.
- Stainless steel screws in lid.
- IP68 rated.
- Temperature range -60°C to +200°C.
- Available in natural aluminium or powder coat finish.

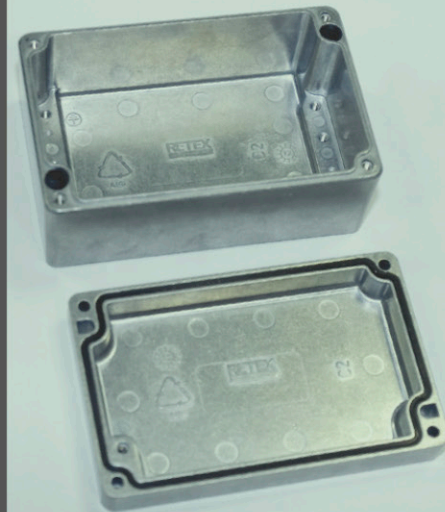

IP68 DIE CAST ENCLOSURES - SERIES 68

High impact IP68 rated diecast Enclosures available in natural aluminium and powder coat Silver, Grey or Black. Manufactured in corrosion resistant aluminium alloy with stainless steel screws, these products are suitable for safely enclosing electronic components, PCB's or E-Mech components (Relays, switches etc) in areas that are generally considered too harsh for other enclosure materials.

Product Code	IP Rating	Colour	Enclosure Material	H (mm)	W (mm)	D (mm)	Temp Rating	Description	Comments
31068001	68	Natural Aluminium	Aluminium Alloy ENAC-GdAlSi12(Fe)	45	50	30	-60°C to +200°C	High impact IP68 rated corrosion resistant natural aluminium diecast enclosure with stainless steel screws. Suitable for safely enclosing electronic components in areas that are generally considered too harsh for other enclosure materials.	
31068002	68			64	58	34	-60°C to +200°C		
31068003	68			75	80	57	-60°C to +200°C		
31068004	68			125	80	57	-60°C to +200°C		
31068005	68			175	80	57	-60°C to +200°C		
31068006	68			120	122	81	-60°C to +200°C		
31068007	68			120	122	91	-60°C to +200°C		
31068008	68			250	80	57	-60°C to +200°C		
31068009	68			100	100	81	-60°C to +200°C		
31068010	68			140	140	91	-60°C to +200°C		
31068111	68	Grey RAL 7001	Aluminium Alloy ENAC-GdAlSi12(Fe)	45	50	30	-60°C to +200°C	High impact IP68 rated corrosion resistant Silver grey aluminium diecast enclosure with stainless steel screws. Suitable for safely enclosing electronic components in areas that are generally considered too harsh for other enclosure materials.	Product approved to IEC 60529:2001-DIN EN6059
31068112	68			64	58	34	-60°C to +200°C		
31068113	68			75	80	57	-60°C to +200°C		
31068114	68			125	80	57	-60°C to +200°C		
31068115	68			175	80	57	-60°C to +200°C		
31068116	68			120	122	81	-60°C to +200°C		
31068117	68			120	122	91	-60°C to +200°C		
31068118	68			250	80	57	-60°C to +200°C		
31068119	68			100	100	81	-60°C to +200°C		
31068120	68			140	140	91	-60°C to +200°C		
31068201	68	Black RAL 9004	Aluminium Alloy ENAC-GdAlSi12(Fe)	45	50	30	-60°C to +200°C	High impact IP68 rated corrosion resistant black aluminium diecast enclosure with stainless steel screws. Suitable for safely enclosing electronic components in areas that are generally considered too harsh for other enclosure materials.	
31068202	68			64	58	34	-60°C to +200°C		
31068203	68			75	80	57	-60°C to +200°C		
31068204	68			125	80	57	-60°C to +200°C		
31068205	68			175	80	57	-60°C to +200°C		
31068206	68			120	122	81	-60°C to +200°C		
31068207	68			120	122	91	-60°C to +200°C		
31068208	68			250	80	57	-60°C to +200°C		
31068209	68			100	100	81	-60°C to +200°C		
31068210	68			140	140	91	-60°C to +200°C		

IP66, IK08 ENCLOSURES / JUNCTION BOXES

This range of general purpose Enclosures are supplied complete with 35mm DIN rail section for internal component mounting.

The ABS Enclosures are moulded with internal mounting stand-offs and the lids are secured by captive plastic screws once inserted into the lid. Optional transparent Polycarbonate lids are available for selected models and the products are suitable for use as a cable junction box or to enclose PCB's, control & E-Mech components.

Features:

- Available in 7 sizes
- Sealed to IP66
- Captive plastic screws in lid
- Supplied c/w 35mm DIN RAIL section & mounting screws etc
- Multiple slots for vertical PCB mounting
- Supplied in Flame Retardant ABS to UL94-HB
- Top cover available in solid grey (as base) or transparent
- Robust to IK08

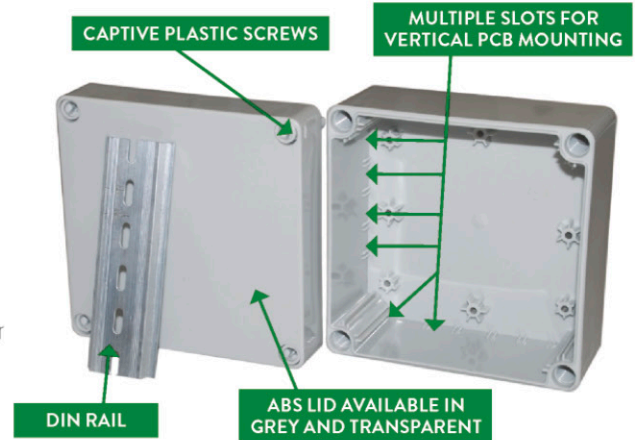

BLANK DOOR DN ENCLOSURES

Product Code	IP Rating	Base Colour	Lid Colour	Enclosure Material	W (mm)	H (mm)	D (mm)	Temp Rating	Description
DN12E	66	Grey	Grey	ABS	125	125	75	-10°C to +80°C	Grey RAL 7035 IP66 general purpose ABS enclosure with internal mounting stand-offs.
DN13E	66				125	125	100	-10°C to +80°C	
DN14E	66				125	175	75	-10°C to +80°C	
DN15E	66				125	175	100	-10°C to +80°C	
DN16E	66				125	175	125	-10°C to +80°C	
DN17E	66				125	175	150	-10°C to +80°C	
DN18E	66				175	175	125	-10°C to +80°C	

TRANSPARENT DOOR DN ENCLOSURES

DN12T	66	Grey	Transparent	ABS	125	125	75	-10°C to +80°C	Grey RAL 7035 IP66 general purpose ABS enclosure with internal mounting stand-offs and supplied with clear polycarbonate lid.
DN13T	66				125	125	100	10°C to +80°C	
DN14T	66				125	175	75	-10°C to +80°C	
DN15T	66				125	125	100	-10°C to +80°C	
DN16T	66				125	175	125	-10°C to +80°C	
DN17T	66				125	175	150	-10°C to +80°C	
DN18T	66				175	175	125	-10°C to +80°C	

DN ACCESSORIES

Product Code	Description
DNMPS/1	Galvanised Steel Mounting Plate for DN12 & DN13
DNMPS/2	Galvanised Steel Mounting Plate for DN14, DN15 & DN16

ACCESSORIES



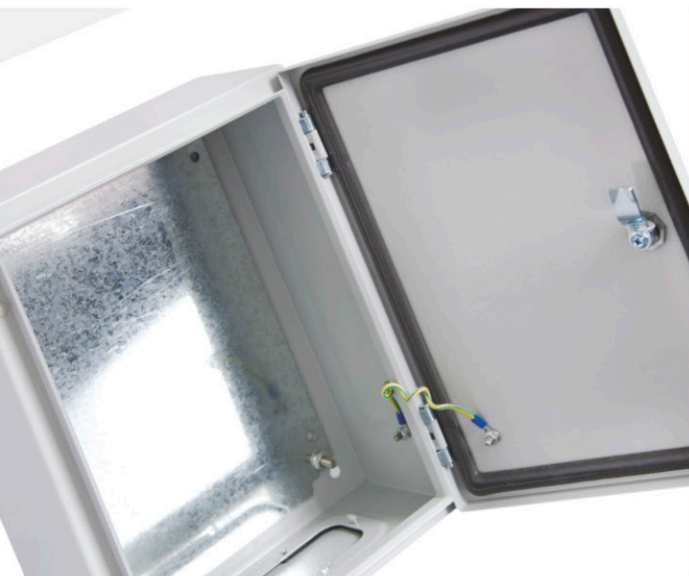

IP66, IK10 STEEL DOOR ENCLOSURES

Features:

- Galvanised steel housing guaranteed for 3 years against corrosion
- 2mm galvanised steel back plate guaranteed for 3 years against corrosion
- Gland plate with IP66 sealing gasket for top or base mounting.
- Supplied c/w galvanised wall mounting brackets
- Powder coated in grey RAL7035
- All threaded studs are stainless steel thus fully corrosion proof
- All with earth stud pre wired door to housing
- Compliance to IEC 60529

IP66 STEEL DOOR ENCLOSURES

Product Code	IP Rating	Colour	Material	H (mm)	W (mm)	D (mm)	Temp Rating	Gland Plate (mm)	Mounting Plate (mm)	No. of Locks	Description
DEDS0099	66	Grey RAL 7035	Steel	250	200	130	-20°C to +55°C	130x60	265x150	1	Lockable, with galvanised steel back plate and wall mounting brackets supplied*
DEDS0100	66			300	200	130	-20°C to +55°C	168x95	265x150	1	
DEDS0102	66			300	300	150	-20°C to +55°C	208x95	265x250	1	
DEDS0200	66			350	250	150	-20°C to +55°C	168x95	315x200	1	
DEDS0300	66			500	400	175	-20°C to +55°C	208x95	465x350	1	
DEDS0400	66			400	300	170	-20°C to +55°C	208x95	365x250	1	
DEDS0500	66			400	300	220	-20°C to +55°C	208x95	365x250	1	
DEDS0502	66			400	400	200	-20°C to +55°C	345x146	365x350	1	
DEDS0600	66			500	350	190	-20°C to +55°C	208x95	465x300	1	
DEDS0601	66			500	400	200	-20°C to +55°C	345x146	465x350	1	
DEDS0611	66			500	400	175	-20°C to +55°C	208x95	465x350	1	
DEDS0700	66			500	400	240	-20°C to +55°C	345x146	465x350	1	
DEDS0702	66			500	500	200	-20°C to +55°C	445x146	465x350	1	
DEDS0800	66			600	400	200	-20°C to +55°C	345x146	565x350	2	
DEDS0802	66			600	400	250	-20°C to +55°C	345x146	565x350	2	
DEDS0803	66			600	600	200	-20°C to +55°C	445x146	565x350	2	
DEDS0900	66			800	400	200	-20°C to +55°C	317x120	765x350	2	
DEDS1000	66			700	500	250	-20°C to +55°C	445x146	665x450	2	
DEDS1001	66			800	600	260	-20°C to +55°C	445x146	765x550	2	
DEDS1012	66			1000	600	300	-20°C to +55°C	445x146	965x550	2	
DEDS1013	66	1250	600	300	-20°C to +55°C	445x146	1215x550	2			

* Galvanised steel resistant to corrosion



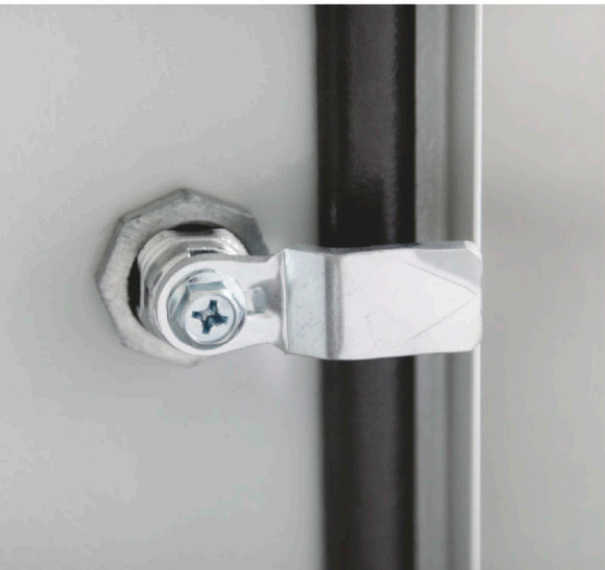

IP66, IK10 STAINLESS STEEL DOOR ENCLOSURES

Features:

- Galvanised steel back plate guaranteed for 3 years against corrosion
- Stainless Steel Threaded Bolts
- Stainless Steel Earth Bolts
- Prewired Earth Link
- Metal Lock & Key
- Galvanised Wall Fixing Brackets

IP66/IK08 STAINLESS STEEL DOOR ENCLOSURES

Product Code	IP Rating	Colour	Material	H (mm)	W (mm)	D (mm)	Temp Rating	Gland Plate (mm)	Mounting Plate (mm)	No. of Locks	Description
DESS3101	66	Stainless steel polished finish	Stainless steel grade SS304	300	200	150	-20°C to +55°C	168x95	265x150	1	Lockable, with galvanized steel back plate and wall mounting brackets supplied*
DESS3102	66			300	300	150	-20°C to +55°C	208x95	265x250	1	
DESS3402	66			400	300	200	-20°C to +55°C	208x95	365x250	1	
DESS3502	66			400	400	200	-20°C to +55°C	345x146	365x350	1	
DESS3601	66			500	400	200	-20°C to +55°C	345x146	465x350	1	
DESS3702	66			500	500	200	-20°C to +55°C	445x146	465x450	1	



DEDS ACCESSORIES

Product Code	Description
DEDSPH	Factory Fitted Punched Hole Per Hole
DEDSMPP0099	Perforated Back Plate for DEDS0099
DEDSMPP0100	Perforated Back Plate for DEDS0100
DEDSMPP0200	Perforated Back Plate for DEDS0200
DEDSMPP0400	Perforated Back Plate for DEDS0400
DEDSMPP0500	Perforated Back Plate for DEDS0500
DEDSMPP0600	Perforated Back Plate for DEDS0600

OTHER DEDS ACCESSORIES



CABLE GLANDS
M12, M16, M20 & M25



KWIK-FIX CABLE GLANDS
M16, M20 & M25



VENTING ELEMENTS
M12 & M20



CONTACTORS/
THERMAL
OVERLOADS



FILTER FANS



FANS



IP65, IK08 ABS DOOR ENCLOSURES

Features:

- Available in 8 sizes.
- Made from UL approved ABS-HB Flame Retardant plastic.
- Designed to meet protection and impact standards IP65 and IK08.
- Comes complete with galvanised steel back plate and mounting brackets.
- Supplied in grey (RAL 7035) body with solid or transparent door.
- Suitable for use in sea salt air conditions and dry dust environments.
- Temperature range of -20°C to +85°C.
- Compliant with EN60439-1, EN62208, CEI 23-48 and CEI 23-49.

BLANK DOOR ENCLOSURES



Product Code	IP Rating	Colour	Material	H (mm)	W (mm)	D (mm)	Temp Rating	Description
DED001	65	Grey RAL 7035	ABS-HB	300	200	130	-20°C to +85°C	Lockable, with steel back plate*
DED002	65			350	250	150	-20°C to +85°C	
DED004	65			400	300	170	-20°C to +85°C	
DED005	65			400	300	220	-20°C to +85°C	
DED006	65			500	350	190	-20°C to +85°C	
DED007	65			500	400	240	-20°C to +85°C	
DED008	65			600	400	200	-20°C to +85°C	
DED010	65			700	500	250	-20°C to +85°C	
DED3003	65			500	400	175	-20°C to +85°C	
DED3021	65			800	600	260	-20°C to +85°C	

TRANSPARENT DOOR ENCLOSURES



Product Code	IP Rating	Colour	Material	H (mm)	W (mm)	D (mm)	Temp Rating	Description
DED011	65	Grey RAL 7035/ Transparent Door	ABS-HB Body/ Polycarbonate Door	300	200	130	-20°C to +85°C	Lockable, with steel back plate*
DED012	65			350	250	150	-20°C to +85°C	
DED014	65			400	300	170	-20°C to +85°C	
DED015	65			400	300	220	-20°C to +85°C	
DED016	65			500	350	190	-20°C to +85°C	
DED017	65			500	400	240	-20°C to +85°C	
DED018	65			600	400	200	-20°C to +85°C	
DED020	65			700	500	250	-20°C to +85°C	
DED3013	65			500	400	175	-20°C to +85°C	
DED3022	65			800	600	260	-20°C to +85°C	

* Galvanised steel resistant to corrosion



STEEL MOUNTING PLATES

INTRODUCING TH381

NEW PLUG & SOCKET MICRO-CONNECTOR

IDEAL FOR ANY LIGHTING APPLICATION WHERE DIMENSIONS MAKE THE DIFFERENCE

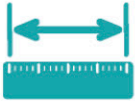

Miniaturised

The smallest connector on the market with a diameter of only 14mm



IP68

IP69K

Submersion and high pressure water resistant
With IP68 & IP69K ratings



Screw wire connector

Unique dimensions which can be used with wires up to 1.5mm²



Ø 14 mm

14 mm



ARCHITECTURAL LIGHTING



LIGHTING IN WATER



STREET LIGHTING



URBAN LIGHTING



ROAD SIGNS & ADVERTISING BILLBOARDS

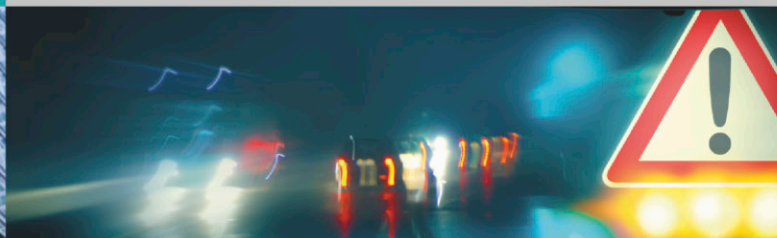

To find out more please visit www.hylec-apl.com

HAND HELD ABS INSTRUMENT CASES



SERIES 31

Hand held ABS enclosure, snap fit assembly, suitable for housing electronics for remote key applications etc. EPDM gasket to improve sealing to IP65 (IP60 rating for standard enclosure) and a 3 or 6 button membrane keypad are available options for these products.

Features:

- Modern design.
- Recess in cover for membrane keypad.
- Snap fit assembly.
- Gasket and keypad options.
- Temperature resistant to 85°C.



Product Code	IP Rating	Base Colour	Lid Colour	Enclosure Material	H (mm)	W (mm)	D (mm)	Temp Rating
33131001	See Comments	Grey RAL 7035	Grey RAL 7035	ABS	55	40	18	0°C to +85°C
33131002		Grey RAL 7036	Grey RAL 7036		60	40	18	0°C to +85°C
33131003		Grey RAL 7037	Grey RAL 7037		70	50	20	0°C to +85°C
33131004		Grey RAL 7038	Grey RAL 7038		55	40	18	0°C to +85°C
33131202		Black RAL 9004	Black RAL 9004		60	40	18	0°C to +85°C
33131203		Black RAL 9004	Black RAL 9004		70	50	20	0°C to +85°C

SERIES 32

Hand held 3mm thick ABS enclosure, snap fit assembly, suitable for housing electronics for remote control or instrumentation applications etc. EPDM gasket to improve sealing to IP65 and specific models in the range also include an integrated battery compartment with separate cover.

Features:

- Manufactured in tough 3mm thick ABS material.
- Separate battery compartment with separate cover on specific models in the range.
- Snap fit assembly.
- Gasket option to increase IP rating to IP65.
- IP60 rating for standard enclosure
- Temperature resistant to 85°C.



Product Code	IP Rating	Base Colour	Lid Colour	Enclosure Material	H (mm)	W (mm)	D (mm)	Temp Rating	
33132002	See Comments	Grey RAL 7035	Grey RAL 7035	ABS	100	75	30	0°C to +85°C	
33132003					100	75	20	0°C to +85°C	
33132004					120	75	30	0°C to +85°C	
33132005					120	75	20	0°C to +85°C	
33132202		Black RAL 9004	Black RAL 9004		Black RAL 9004	100	75	30	0°C to +85°C
33132203						100	75	20	0°C to +85°C
33132204						120	75	30	0°C to +85°C
33132205						120	75	20	0°C to +85°C



	Description	Comments
	Snap fit assembly hand-held ABS enclosure. Three button membrane keypad and sealing gasket accessories are also available.	IP Rating can be increased to IP65 by fitting the EPDM gasket seal part number 33070041. IP60 rating for standard enclosure.
	Snap fit assembly hand-held ABS enclosure. Six button membrane keypad and sealing gasket accessories are also available.	IP Rating can be increased to IP65 by fitting the EPDM gasket seal part number 33070042. IP60 rating for standard enclosure.
	Snap fit assembly hand-held ABS enclosure. Three button membrane keypad and sealing gasket accessories are also available.	IP Rating can be increased to IP65 by fitting the EPDM gasket seal part number 33070044. IP60 rating for standard enclosure.
	Snap fit assembly hand-held ABS enclosure. Six button membrane keypad and sealing gasket accessories are also available.	IP Rating can be increased to IP65 by fitting the EPDM gasket seal part number 33070041. IP60 rating for standard enclosure.

	Description	Comments
	Snap fit hand-held robust construction ABS enclosure with 3mm thick mouldings. Suitable for remote control or instrumentation applications etc. This product also includes an integrated battery compartment with separate cover.	
	Snap fit hand-held robust construction ABS enclosure with 3mm thick mouldings. Suitable for remote control or instrumentation applications etc.	
	Snap fit hand-held robust construction ABS enclosure with 3mm thick mouldings. Suitable for remote control or instrumentation applications etc. This product also includes an integrated battery compartment with separate cover.	
	Snap fit hand-held robust construction ABS enclosure with 3mm thick mouldings. Suitable for remote control or instrumentation applications etc.	IP Rating can be increased to IP65 by fitting the EPDM gasket seal part number 33070045.
	Snap fit hand-held robust construction ABS enclosure with 3mm thick mouldings. Suitable for remote control or instrumentation applications etc. This product also includes an integrated battery compartment with separate cover.	IP60 rating for standard enclosure.
	Snap fit hand-held robust construction ABS enclosure with 3mm thick mouldings. Suitable for remote control or instrumentation applications etc.	
	Snap fit hand-held robust construction ABS enclosure with 3mm thick mouldings. Suitable for remote control or instrumentation applications etc. This product also includes an integrated battery compartment with separate cover.	
	Snap fit hand-held robust construction ABS enclosure with 3mm thick mouldings. Suitable for remote control or instrumentation applications etc.	

HAND HELD ABS INSTRUMENT CASES

SERIES 33

Ergonomically designed hand held ABS enclosure that is snap-fit and screw assembly. The main enclosure is manufactured from robust 3mm thick ABS whilst the separately ordered colour coded corners are manufactured in Polypropylene coated with a TPE non-slip material for more positive handling. An optional EPDM gasket to improve sealing to IP65 is also available and specific models in the range also have an integrated battery compartment which has a screw fixing cover. These products are particularly suitable for housing electronics for remote control or instrumentation applications that require a tough and resilient product.

Features:

- Ergonomically designed for more comfortable use.
- Manufactured in tough 3mm thick ABS material.
- Separate battery compartment and cover on specific models in the range.
- Snap fit and screw assembly.
- Gasket option to increase IP rating to IP65.
- Colour coded non-slip corners available separately.
- Temperature resistant to +85°C.



Product Code	IP Rating	Base Colour	Lid Colour	Enclosure Material	H (mm)	W (mm)	D (mm)	Temp Rating
33133301	See Comments	Black RAL 9004	Black RAL 9004	ABS	145	95	25	0°C to +85°C
33133302					145	95	35	0°C to +85°C
33133303					185	110	25	0°C to +85°C
33133304					185	110	35	0°C to +85°C
33133305					200	120	25	0°C to +85°C
33133306					200	120	35	0°C to +85°C
33133311		Grey RAL 7035	Grey RAL 7035		145	95	25	0°C to +85°C
33133312					145	95	35	0°C to +85°C
33133313					185	110	25	0°C to +85°C
33133314					185	110	35	0°C to +85°C
33133315					200	120	25	0°C to +85°C
33133316					200	120	35	0°C to +85°C

SERIES 33 ACCESSORIES

Product Code	IP Rating	Base Colour	Enclosure Material	Temp Rating	Description	Comments
33070045	See comments		EPDM	0°C to +85°C	IP Sealing Gasket	Suitable for fitting to all Series 33 hand held Enclosures which will increase IP rating to IP65.
33133225		Blue RAL 5007	Polypropylene covered with TPE non-slip material	0°C to +85°C	Blue corner section	Supplied in packs of 4 pcs.
33133325		Green RAL 6026		0°C to +85°C	Green corner section	
33133425		Red RAL 3020		0°C to +85°C	Red corner section	
33133525		Orange RAL 2003		0°C to +85°C	Orange corner section	
33133625		Black RAL 9004		0°C to +85°C	Black corner section	
33133725		Yellow RAL 1021		0°C to +85°C	Yellow corner section	

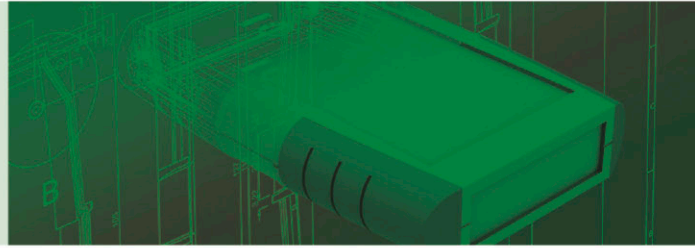

	Description	Comments
	Robust hand held ABS Enclosure. Supplied as a basic shell the product can be colour coded for specific applications by fitment of the separately ordered colour coded corners.	
	Robust hand held ABS Enclosure. Supplied as a basic shell the product can be colour coded for specific applications by fitment of the separately ordered colour coded corners. Includes an integrated battery compartment with separate cover.	
	Robust hand held ABS Enclosure. Supplied as a basic shell the product can be colour coded for specific applications by fitment of the separately ordered colour coded corners.	
	Robust hand held ABS Enclosure. Supplied as a basic shell the product can be colour coded for specific applications by fitment of the separately ordered colour coded corners. Includes an integrated battery compartment with separate cover.	
	Robust hand held ABS Enclosure. Supplied as a basic shell the product can be colour coded for specific applications by fitment of the separately ordered colour coded corners.	
	Robust hand held ABS Enclosure. Supplied as a basic shell the product can be colour coded for specific applications by fitment of the separately ordered colour coded corners. Includes an integrated battery compartment with separate cover.	
	Robust hand held ABS Enclosure. Supplied as a basic shell the product can be colour coded for specific applications by fitment of the separately ordered colour coded corners.	
	Robust hand held ABS Enclosure. Supplied as a basic shell the product can be colour coded for specific applications by fitment of the separately ordered colour coded corners. Includes an integrated battery compartment with separate cover.	
	Robust hand held ABS Enclosure. Supplied as a basic shell the product can be colour coded for specific applications by fitment of the separately ordered colour coded corners.	
	Robust hand held ABS Enclosure. Supplied as a basic shell the product can be colour coded for specific applications by fitment of the separately ordered colour coded corners. Includes an integrated battery compartment with separate cover.	
	Robust hand held ABS Enclosure. Supplied as a basic shell the product can be colour coded for specific applications by fitment of the separately ordered colour coded corners.	
	Robust hand held ABS Enclosure. Supplied as a basic shell the product can be colour coded for specific applications by fitment of the separately ordered colour coded corners. Includes an integrated battery compartment with separate cover.	
	Robust hand held ABS Enclosure. Supplied as a basic shell the product can be colour coded for specific applications by fitment of the separately ordered colour coded corners.	
	Robust hand held ABS Enclosure. Supplied as a basic shell the product can be colour coded for specific applications by fitment of the separately ordered colour coded corners. Includes an integrated battery compartment with separate cover.	

IP Rating can be increased to IP65 by fitting the EPDM gasket seal part number 33070045. Dimensions shown include fitted corners.
IP60 rating for standard enclosure.

SERIES 33 ACCESSORIES

Product Code	IP Rating	Base Colour	Enclosure Material	Temp Rating	Description	Comments
33133825	See comments	Grey RAL 7035	Polypropylene covered with TPE non-slip material	0°C to +85°C	Grey corner section	Supplied in packs of 4 pcs.
33133235		Blue RAL 5007		0°C to +85°C	Blue corner section	
33133335		Green RAL 6026		0°C to +85°C	Green corner section	
33133435		Red RAL 3020		0°C to +85°C	Red corner section	
33133535		Orange RAL 2003		0°C to +85°C	Orange corner section	
33133635		Black RAL 9004		0°C to +85°C	Black corner section	
33133735		Yellow RAL 1021		0°C to +85°C	Yellow corner section	
33133835		Grey RAL 7035		0°C to +85°C	Grey corner section	

ALUMINIUM/STEEL DESKTOP INSTRUMENT CASES

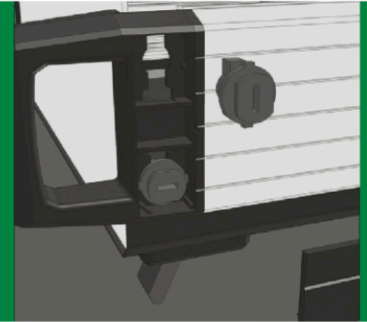

SERIES 110

Instrument cases for command test and control applications. Side profiles include rails for mounting PCB's and other components whilst the ventilation slots on the rear of lid and the base allow for cooling of enclosed electronic components. All products are supplied with non-slip feet.

Features:

- Robust instrument cases for a variety of industrial and control applications.
- Solid steel and aluminium construction.
- Side profiles include rails for PCB or other component mounting.
- Ventilation slots in top and bottom covers.
- Non-slip feet or tilting feet fitted as standard.



Product Code	Lid Colour	Enclosure Material	H (mm)	W (mm)	D (mm)	Temp Rating	Description
31110001	Lid and base graphite Grey Aluminium extrusions and front and rear panels Silver	Aluminium extrusion profiles Steel lid and base	70	150	140	0°C to +85°C	Ideal for use in laboratory, industrial or on-site these rugged Enclosures will provide the required protection for the enclosed electronics. All products are supplied complete with vented panels and non-slip feet.
31110002			70	200	200	0°C to +85°C	
31110003			80	225	170	0°C to +85°C	
31110004			90	250	200	0°C to +85°C	Ideal for use in laboratory, industrial or on-site these rugged Enclosures will provide the required protection for the enclosed electronics. All products are supplied complete with vented panels and non-slip feet and this model also has front feet that can be opened out to give a 6° angle from the horizontal to aid vision and use of the equipment.
31110005			100	300	220	0°C to +85°C	
31110006			120	350	260	0°C to +85°C	
31110007			130	400	300	0°C to +85°C	



A BOX

Instrument console for desktop applications. Specially designed for equipments such as intercoms, displays, test or control units.



Features:

- Complete with PCB Mounting Slots.
- Suitable for mounting Eurocards to IEC60297 in every size.
- Fitted with non-slip feet.
- Maximum temperature +85°C.

Product Code	Lid Colour	Enclosure Material	H (mm)	W (mm)	D (mm)	Temp Rating	Description	Comments
33020101	Light Grey and Silver	Lid and Base ABS Aluminium display panels Silver anodised	62	195	120	0°C to +85°C	Instrument console for desktop applications, sloped display.	Bosses included for PCB mounting and product also supplied complete with 4 non-slip feet and mounting screws.
33020102			78	268	185	0°C to +85°C		
33020103			117,5	268	185	0°C to +85°C	Instrument console for desktop applications, sloped and angled display.	
33020104			86,5	400	230	0°C to +85°C	Instrument console for desktop applications, sloped display.	
33020105	147		400	230	0°C to +85°C	Instrument console for desktop applications, sloped and angled display.		
33020111	Black and Silver		62	195	120	0°C to +85°C	Instrument console for desktop applications, sloped display.	
33020112			78	268	185	0°C to +85°C		
33020113			117,5	268	185	0°C to +85°C	Instrument console for desktop applications, sloped and angled display.	
33020114			86,5	400	230	0°C to +85°C	Instrument console for desktop applications, sloped display.	
33020115			147	400	230	0°C to +85°C	Instrument console for desktop applications, sloped and angled display.	

IP67 DE ENCLOSURES WITHOUT HOLE

Reg. Design

Features:

- Available in 4 sizes - standard & deep base.
- Sealed to IP67.
- Complete with M20 cable knockouts.
- Captive plastic screws in lid.
- Available in standard and deep base.
- Suitable for enclosing printed circuit boards - vertically (via mounting slots) or horizontally.
- Unique snap-on DIN rail and flange brackets available.
- Also available in ABS-UL94-V0.
- Temperature rating of -10°C to +65°C.

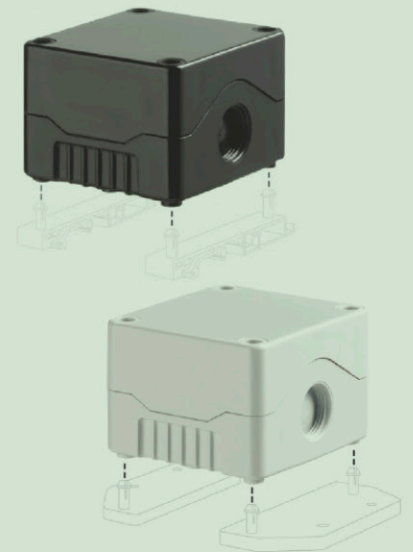

DE01 ENCLOSURE STANDARD BASE - 53MM



Product Code	IP Rating	Colour	Material	H (mm)	W (mm)	D (mm)	Temp Rating
DE01S-A-BB-0	67	Black/Black	ABS-UL94-HB	80	73	53	-10°C to +65°C
DE01S-A-GG-0	67	Grey/Grey		80	73	53	-10°C to +65°C
DE01S-A-BG-0	67	Black/Grey		80	73	53	-10°C to +65°C
DE01S-A-GB-0	67	Grey/Black		80	73	53	-10°C to +65°C
DE01S-A-TB-0	67	Transparent/Black		80	73	53	-10°C to +65°C
DE01S-A-TG-0	67	Transparent/Grey		80	73	53	-10°C to +65°C
DE01S-P-BB-0	67	Black/Black	Polycarbonate UL94-V0	80	73	53	-10°C to +65°C
DE01S-P-GG-0	67	Grey/Grey		80	73	53	-10°C to +65°C
DE01S-P-BG-0	67	Black/Grey		80	73	53	-10°C to +65°C
DE01S-P-GB-0	67	Grey/Black		80	73	53	-10°C to +65°C
DE01S-P-TB-0	67	Transparent/Black		80	73	53	-10°C to +65°C
DE01S-P-TG-0	67	Transparent/Grey		80	73	53	-10°C to +65°C

DE01 ENCLOSURE DEEP BASE - 78MM



DE01D-A-BB-0	67	Black/Black	ABS-UL94-HB	80	73	78	-10°C to +65°C
DE01D-A-GG-0	67	Grey/Grey		80	73	78	-10°C to +65°C
DE01D-A-BG-0	67	Black/Grey		80	73	78	-10°C to +65°C
DE01D-A-GB-0	67	Grey/Black		80	73	78	-10°C to +65°C
DE01D-A-TB-0	67	Transparent/Black		80	73	78	-10°C to +65°C
DE01D-A-TG-0	67	Transparent/Grey		80	73	78	-10°C to +65°C
DE01D-P-BB-0	67	Black/Black	Polycarbonate UL94-V0	80	73	78	-10°C to +65°C
DE01D-P-GG-0	67	Grey/Grey		80	73	78	-10°C to +65°C
DE01D-P-BG-0	67	Black/Grey		80	73	78	-10°C to +65°C
DE01D-P-GB-0	67	Grey/Black		80	73	78	-10°C to +65°C
DE01D-P-TB-0	67	Transparent/Black		80	73	78	-10°C to +65°C
DE01D-P-TG-0	67	Transparent/Grey		80	73	78	-10°C to +65°C

DE02 ENCLOSURE STANDARD BASE - 53MM



DE02S-A-BB-0	67	Black/Black	ABS-UL94-HB	80	106	53	-10°C to +65°C
DE02S-A-GG-0	67	Grey/Grey		80	106	53	-10°C to +65°C
DE02S-A-BG-0	67	Black/Grey		80	106	53	-10°C to +65°C
DE02S-A-GB-0	67	Grey/Black		80	106	53	-10°C to +65°C
DE02S-A-TB-0	67	Transparent/Black		80	106	53	-10°C to +65°C
DE02S-A-TG-0	67	Transparent/Grey		80	106	53	-10°C to +65°C
DE02S-P-BB-0	67	Black/Black	Polycarbonate UL94-V0	80	106	53	-10°C to +65°C
DE02S-P-GG-0	67	Grey/Grey		80	106	53	-10°C to +65°C
DE02S-P-BG-0	67	Black/Grey		80	106	53	-10°C to +65°C
DE02S-P-GB-0	67	Grey/Black		80	106	53	-10°C to +65°C
DE02S-P-TB-0	67	Transparent/Black		80	106	53	-10°C to +65°C
DE02S-P-TG-0	67	Transparent/Grey		80	106	53	-10°C to +65°C

IP67 DE ENCLOSURES WITHOUT HOLE

DE02 ENCLOSURE DEEP BASE - 78MM



Product Code	IP Rating	Colour	Material	H (mm)	W (mm)	D (mm)	Temp Rating
DE02D-A-BB-0	67	Black/Black	ABS-UL94-HB	80	106	78	-10°C to +65°C
DE02D-A-GG-0	67	Grey/Grey		80	106	78	-10°C to +65°C
DE02D-A-BG-0	67	Black/Grey		80	106	78	-10°C to +65°C
DE02D-A-GB-0	67	Grey/Black		80	106	78	-10°C to +65°C
DE02D-A-TB-0	67	Transparent/Black		80	106	78	-10°C to +65°C
DE02D-A-TG-0	67	Transparent/Grey		80	106	78	-10°C to +65°C
DE02D-P-BB-0	67	Black/Black	Polycarbonate UL94-V0	80	106	78	-10°C to +65°C
DE02D-P-GG-0	67	Grey/Grey		80	106	78	-10°C to +65°C
DE02D-P-BG-0	67	Black/Grey		80	106	78	-10°C to +65°C
DE02D-P-GB-0	67	Grey/Black		80	106	78	-10°C to +65°C
DE02D-P-TB-0	67	Transparent/Black		80	106	78	-10°C to +65°C
DE02D-P-TG-0	67	Transparent/Grey		80	106	78	-10°C to +65°C

DE03 ENCLOSURE STANDARD BASE - 53MM



Product Code	IP Rating	Colour	Material	H (mm)	W (mm)	D (mm)	Temp Rating
DE03S-A-BB-0	67	Black/Black	ABS-UL94-HB	80	139	53	-10°C to +65°C
DE03S-A-GG-0	67	Grey/Grey		80	139	53	-10°C to +65°C
DE03S-A-BG-0	67	Black/Grey		80	139	53	-10°C to +65°C
DE03S-A-GB-0	67	Grey/Black		80	139	53	-10°C to +65°C
DE03S-A-TB-0	67	Transparent/Black		80	139	53	-10°C to +65°C
DE03S-A-TG-0	67	Transparent/Grey		80	139	53	-10°C to +65°C
DE03S-P-BB-0	67	Black/Black	Polycarbonate UL94-V0	80	139	53	-10°C to +65°C
DE03S-P-GG-0	67	Grey/Grey		80	139	53	-10°C to +65°C
DE03S-P-BG-0	67	Black/Grey		80	139	53	-10°C to +65°C
DE03S-P-GB-0	67	Grey/Black		80	139	53	-10°C to +65°C
DE03S-P-TB-0	67	Transparent/Black		80	139	53	-10°C to +65°C
DE03S-P-TG-0	67	Transparent/Grey		80	139	53	-10°C to +65°C

DE03 ENCLOSURE DEEP BASE - 78MM



Product Code	IP Rating	Colour	Material	H (mm)	W (mm)	D (mm)	Temp Rating
DE03D-A-BB-0	67	Black/Black	ABS-UL94-HB	80	139	78	-10°C to +65°C
DE03D-A-GG-0	67	Grey/Grey		80	139	78	-10°C to +65°C
DE03D-A-BG-0	67	Black/Grey		80	139	78	-10°C to +65°C
DE03D-A-GB-0	67	Grey/Black		80	139	78	-10°C to +65°C
DE03D-A-TB-0	67	Transparent/Black		80	139	78	-10°C to +65°C
DE03D-A-TG-0	67	Transparent/Grey		80	139	78	-10°C to +65°C
DE03D-P-BB-0	67	Black/Black	Polycarbonate UL94-V0	80	139	78	-10°C to +65°C
DE03D-P-GG-0	67	Grey/Grey		80	139	78	-10°C to +65°C
DE03D-P-BG-0	67	Black/Grey		80	139	78	-10°C to +65°C
DE03D-P-GB-0	67	Grey/Black		80	139	78	-10°C to +65°C
DE03D-P-TB-0	67	Transparent/Black		80	139	78	-10°C to +65°C
DE03D-P-TG-0	67	Transparent/Grey		80	139	78	-10°C to +65°C

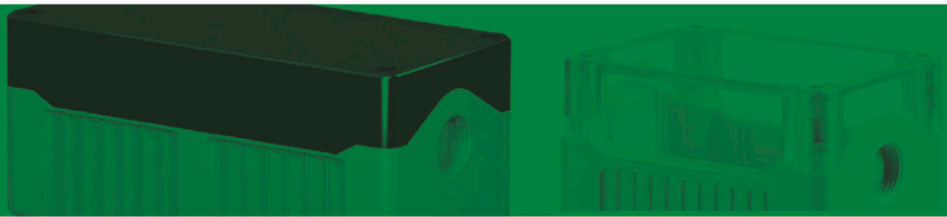

DE04 ENCLOSURE STANDARD BASE - 53MM



Product Code	IP Rating	Colour	Material	H (mm)	W (mm)	D (mm)	Temp Rating
DE04S-A-BB-0	67	Black/Black	ABS-UL94-HB	80	172	53	-10°C to +65°C
DE04S-A-GG-0	67	Grey/Grey		80	172	53	-10°C to +65°C
DE04S-A-BG-0	67	Black/Grey		80	172	53	-10°C to +65°C
DE04S-A-GB-0	67	Grey/Black		80	172	53	-10°C to +65°C
DE04S-A-TB-0	67	Transparent/Black		80	172	53	-10°C to +65°C
DE04S-A-TG-0	67	Transparent/Grey		80	172	53	-10°C to +65°C
DE04S-P-BB-0	67	Black/Black	Polycarbonate UL94-V0	80	172	53	-10°C to +65°C
DE04S-P-GG-0	67	Grey/Grey		80	172	53	-10°C to +65°C
DE04S-P-BG-0	67	Black/Grey		80	172	53	-10°C to +65°C
DE04S-P-GB-0	67	Grey/Black		80	172	53	-10°C to +65°C
DE04S-P-TB-0	67	Transparent/Black		80	172	53	-10°C to +65°C
DE04S-P-TG-0	67	Transparent/Grey		80	172	53	-10°C to +65°C

DE04 ENCLOSURE DEEP BASE - 78MM



Product Code	IP Rating	Colour	Material	H (mm)	W (mm)	D (mm)	Temp Rating
DE04D-A-BB-0	67	Black/Black	ABS-UL94-HB	80	172	78	-10°C to +65°C
DE04D-A-GG-0	67	Grey/Grey		80	172	78	-10°C to +65°C
DE04D-A-BG-0	67	Black/Grey		80	172	78	-10°C to +65°C
DE04D-A-GB-0	67	Grey/Black		80	172	78	-10°C to +65°C
DE04D-A-TB-0	67	Transparent/Black		80	172	78	-10°C to +65°C
DE04D-A-TG-0	67	Transparent/Grey		80	172	78	-10°C to +65°C
DE04D-P-BB-0	67	Black/Black	Polycarbonate UL94-V0	80	172	78	-10°C to +65°C
DE04D-P-GG-0	67	Grey/Grey		80	172	78	-10°C to +65°C
DE04D-P-BG-0	67	Black/Grey		80	172	78	-10°C to +65°C
DE04D-P-GB-0	67	Grey/Black		80	172	78	-10°C to +65°C
DE04D-P-TB-0	67	Transparent/Black		80	172	78	-10°C to +65°C
DE04D-P-TG-0	67	Transparent/Grey		80	172	78	-10°C to +65°C



IP67 DE ENCLOSURES WITH HOLE

A RANGE OF ENCLOSURES SUPPLIED COMPLETE WITH 22MM HOLES FOR FITTING OF SWITCHES/INDICATORS

Reg. Design



Features:

- Complete with M20 cable knockouts.
- 4 sizes available in standard and deep base.
- Also available in Polycarbonate UL94-V0.
- Unique snap-on DIN rail and flange brackets available.
- Suitable for mounting control switches or enclosing printed circuit boards.
- Captive plastic screws in lid.

DE01 ENCLOSURE STANDARD BASE - 53MM WITH 1X22MM HOLE



Product Code	IP Rating*	Colour (Cover/Base)	Material	H (mm)	W (mm)	D (mm)	Temp Rating
DE01S-A-BB-1	67	Black/Black	ABS-UL94-HB	80	73	53	-10°C to +65°C
DE01S-A-GG-1	67	Grey/Grey		80	73	53	-10°C to +65°C
DE01S-A-BG-1	67	Black/Grey		80	73	53	-10°C to +65°C
DE01S-A-GB-1	67	Grey/Black		80	73	53	-10°C to +65°C
DE01S-A-YB-1	67	Yellow/Black		80	73	53	-10°C to +65°C
DE01S-A-YG-1	67	Yellow/Grey		80	73	53	-10°C to +65°C
DE01S-P-BB-1	67	Black/Black	Polycarbonate UL94-V0	80	73	53	-10°C to +65°C
DE01S-P-GG-1	67	Grey/Grey		80	73	53	-10°C to +65°C
DE01S-P-BG-1	67	Black/Grey		80	73	53	-10°C to +65°C
DE01S-P-GB-1	67	Grey/Black		80	73	53	-10°C to +65°C
DE01S-P-YB-1	67	Yellow/Black		80	73	53	-10°C to +65°C
DE01S-P-YG-1	67	Yellow/Grey		80	73	53	-10°C to +65°C

DE01 ENCLOSURE DEEP BASE - 78MM WITH 1X22MM HOLE



DE01D-A-BB-1	67	Black/Black	ABS-UL94-HB	80	73	78	-10°C to +65°C
DE01D-A-GG-1	67	Grey/Grey		80	73	78	-10°C to +65°C
DE01D-A-BG-1	67	Black/Grey		80	73	78	-10°C to +65°C
DE01D-A-GB-1	67	Grey/Black		80	73	78	-10°C to +65°C
DE01D-A-YB-1	67	Yellow/Black		80	73	78	-10°C to +65°C
DE01D-A-YG-1	67	Yellow/Grey		80	73	78	-10°C to +65°C
DE01D-P-BB-1	67	Black/Black	Polycarbonate UL94-V0	80	73	78	-10°C to +65°C
DE01D-P-GG-1	67	Grey/Grey		80	73	78	-10°C to +65°C
DE01D-P-BG-1	67	Black/Grey		80	73	78	-10°C to +65°C
DE01D-P-GB-1	67	Grey/Black		80	73	78	-10°C to +65°C
DE01D-P-YB-1	67	Yellow/Black		80	73	78	-10°C to +65°C
DE01D-P-YG-1	67	Yellow/Grey		80	73	78	-10°C to +65°C

DE02 ENCLOSURE STANDARD BASE - 53MM WITH 2X22MM HOLE



DE02S-A-BB-2	67	Black/Black	ABS-UL94-HB	80	106	53	-10°C to +65°C
DE02S-A-GG-2	67	Grey/Grey		80	106	53	-10°C to +65°C
DE02S-A-BG-2	67	Black/Grey		80	106	53	-10°C to +65°C
DE02S-A-GB-2	67	Grey/Black		80	106	53	-10°C to +65°C
DE02S-A-YB-2	67	Yellow/Black		80	106	53	-10°C to +65°C
DE02S-A-YG-2	67	Yellow/Grey		80	106	53	-10°C to +65°C
DE02S-P-BB-2	67	Black/Black	Polycarbonate UL94-V0	80	106	53	-10°C to +65°C
DE02S-P-GG-2	67	Grey/Grey		80	106	53	-10°C to +65°C
DE02S-P-BG-2	67	Black/Grey		80	106	53	-10°C to +65°C
DE02S-P-GB-2	67	Grey/Black		80	106	53	-10°C to +65°C
DE02S-P-YB-2	67	Yellow/Black		80	106	53	-10°C to +65°C
DE02S-P-YG-2	67	Yellow/Grey		80	106	53	-10°C to +65°C

*IP Rating - Standard construction as 'no-hole' Enclosures are IP67 rated.

Hole enclosure will comply with IP67 rating (max) depending on IP rating of components fitted into unit.

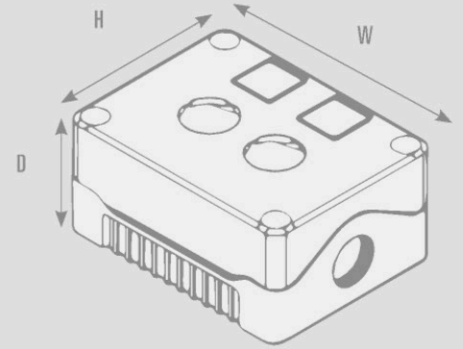
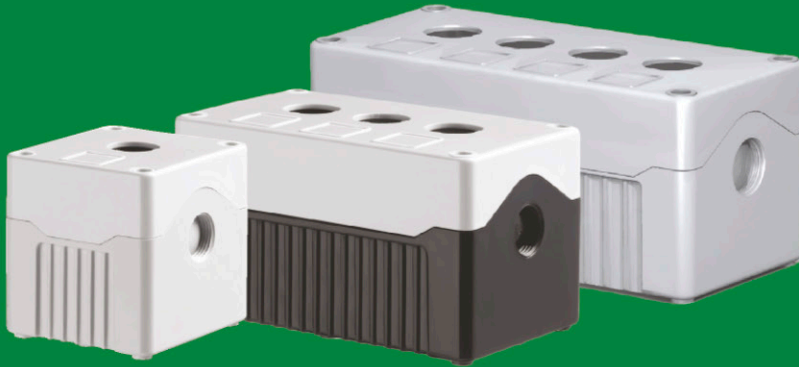

DE02 ENCLOSURE STANDARD BASE - 53MM WITH 2X22MM HOLE



Product Code	IP Rating*	Colour (Cover/Base)	Material	H (mm)	W (mm)	D (mm)	Temp Rating
DE02D-A-BB-2	67	Black/Black	ABS-UL94-HB	80	106	78	-10°C to +65°C
DE02D-A-GG-2	67	Grey/Grey		80	106	78	-10°C to +65°C
DE02D-A-BG-2	67	Black/Grey		80	106	78	-10°C to +65°C
DE02D-A-GB-2	67	Grey/Black		80	106	78	-10°C to +65°C
DE02D-A-YB-2	67	Yellow/Black		80	106	78	-10°C to +65°C
DE02D-A-YG-2	67	Yellow/Grey		80	106	78	-10°C to +65°C
DE02D-P-BB-2	67	Black/Black	Polycarbonate UL94-V0	80	106	78	-10°C to +65°C
DE02D-P-GG-2	67	Grey/Grey		80	106	78	-10°C to +65°C
DE02D-P-BG-2	67	Black/Grey		80	106	78	-10°C to +65°C
DE02D-P-GB-2	67	Grey/Black		80	106	78	-10°C to +65°C
DE02D-P-YB-2	67	Yellow/Black		80	106	78	-10°C to +65°C
DE02D-P-YG-2	67	Yellow/Grey		80	106	78	-10°C to +65°C

DE03 ENCLOSURE STANDARD BASE - 53MM WITH 3X22MM HOLE



DE03S-A-BB-3	67	Black/Black	ABS-UL94-HB	80	139	53	-10°C to +65°C
DE03S-A-GG-3	67	Grey/Grey		80	139	53	-10°C to +65°C
DE03S-A-BG-3	67	Black/Grey		80	139	53	-10°C to +65°C
DE03S-A-GB-3	67	Grey/Black		80	139	53	-10°C to +65°C
DE03S-A-YB-3	67	Yellow/Black		80	139	53	-10°C to +65°C
DE03S-A-YG-3	67	Yellow/Grey		80	139	53	-10°C to +65°C
DE03S-P-BB-3	67	Black/Black	Polycarbonate UL94-V0	80	139	53	-10°C to +65°C
DE03S-P-GG-3	67	Grey/Grey		80	139	53	-10°C to +65°C
DE03S-P-BG-3	67	Black/Grey		80	139	53	-10°C to +65°C
DE03S-P-GB-3	67	Grey/Black		80	139	53	-10°C to +65°C
DE03S-P-YB-3	67	Yellow/Black		80	139	53	-10°C to +65°C
DE03S-P-YG-3	67	Yellow/Grey		80	139	53	-10°C to +65°C

DE03 ENCLOSURE DEEP BASE - 78MM WITH 3X22MM HOLE



DE03D-A-BB-3	67	Black/Black	ABS-UL94-HB	80	139	78	-10°C to +65°C
DE03D-A-GG-3	67	Grey/Grey		80	139	78	-10°C to +65°C
DE03D-A-BG-3	67	Black/Grey		80	139	78	-10°C to +65°C
DE03D-A-GB-3	67	Grey/Black		80	139	78	-10°C to +65°C
DE03D-A-YB-3	67	Yellow/Black		80	139	78	-10°C to +65°C
DE03D-A-YG-3	67	Yellow/Grey		80	139	78	-10°C to +65°C
DE03D-P-BB-3	67	Black/Black	Polycarbonate UL94-V0	80	139	78	-10°C to +65°C
DE03D-P-GG-3	67	Grey/Grey		80	139	78	-10°C to +65°C
DE03D-P-BG-3	67	Black/Grey		80	139	78	-10°C to +65°C
DE03D-P-GB-3	67	Grey/Black		80	139	78	-10°C to +65°C
DE03D-P-YB-3	67	Yellow/Black		80	139	78	-10°C to +65°C
DE03D-P-YG-3	67	Yellow/Grey		80	139	78	-10°C to +65°C

*IP Rating - Standard construction as 'no-hole' Enclosures are IP67 rated.
Hole enclosure will comply with IP67 rating (max) depending on IP rating of components fitted into unit.

IP67 DE ENCLOSURES WITH HOLE

DE04 ENCLOSURE STANDARD BASE - 53MM WITH 4X22MM HOLE



Product Code	IP Rating*	Colour (Cover/Base)	Material	Size	H (mm)	W (mm)	D (mm)	Temp Rating	Description
DE04S-A-BB-4	67	Black/Black	ABS-UL94-HB	DE04S	80	172	53	-10°C to +65°C	
DE04S-A-GG-4	67	Grey/Grey		DE04S	80	172	53	-10°C to +65°C	
DE04S-A-BG-4	67	Black/Grey		DE04S	80	172	53	-10°C to +65°C	
DE04S-A-GB-4	67	Grey/Black		DE04S	80	172	53	-10°C to +65°C	
DE04S-A-YB-4	67	Yellow/Black		DE04S	80	172	53	-10°C to +65°C	
DE04S-A-YG-4	67	Yellow/Grey		DE04S	80	172	53	-10°C to +65°C	
DE04S-P-BB-4	67	Black/Black	Polycarbonate UL94-V0	DE04S	80	172	53	-10°C to +65°C	
DE04S-P-GG-4	67	Grey/Grey		DE04S	80	172	53	-10°C to +65°C	
DE04S-P-BG-4	67	Black/Grey		DE04S	80	172	53	-10°C to +65°C	
DE04S-P-GB-4	67	Grey/Black		DE04S	80	172	53	-10°C to +65°C	
DE04S-P-YB-4	67	Yellow/Black		DE04S	80	172	53	-10°C to +65°C	
DE04S-P-YG-4	67	Yellow/Grey		DE04S	80	172	53	-10°C to +65°C	

DE04 ENCLOSURE DEEP BASE - 78MM WITH 4X22MM HOLE



DE04D-A-BB-4	67	Black/Black	ABS-UL94-HB	DE04D	80	172	78	-10°C to +65°C	
DE04D-A-GG-4	67	Grey/Grey		DE04D	80	172	78	-10°C to +65°C	
DE04D-A-BG-4	67	Black/Grey		DE04D	80	172	78	-10°C to +65°C	
DE04D-A-GB-4	67	Grey/Black		DE04D	80	172	78	-10°C to +65°C	
DE04D-A-YB-4	67	Yellow/Black		DE04D	80	172	78	-10°C to +65°C	
DE04D-A-YG-4	67	Yellow/Grey		DE04D	80	172	78	-10°C to +65°C	
DE04D-P-BB-4	67	Black/Black	Polycarbonate UL94-V0	DE04D	80	172	78	-10°C to +65°C	
DE04D-P-GG-4	67	Grey/Grey		DE04D	80	172	78	-10°C to +65°C	
DE04D-P-BG-4	67	Black/Grey		DE04D	80	172	78	-10°C to +65°C	
DE04D-P-GB-4	67	Grey/Black		DE04D	80	172	78	-10°C to +65°C	
DE04D-P-YB-4	67	Yellow/Black		DE04D	80	172	78	-10°C to +65°C	
DE04D-P-YG-4	67	Yellow/Grey		DE04D	80	172	78	-10°C to +65°C	

*IP Rating - Standard construction as 'no-hole' Enclosures are IP67 rated.

Hole enclosure will comply with IP67 rating (max) depending on IP rating of components fitted into unit.

ACCESSORIES

CABLE GLANDS - GREY



DECGG	68	Grey RAL 7035	Polyamide 6	M20	39.2	10	3.5 to 8	-40°C to +100°C	Fits all sizes of Enclosures, M20 x 1.5mm thread glands
-------	----	------------------	-------------	-----	------	----	----------	-----------------	---

CABLE GLANDS - BLACK

DECGB	68	Black RAL 9005	Polyamide 6	M20	39.2	10	3.5 to 8	-40°C to +100°C	Fits all sizes of Enclosures, M20x1.5mm thread glands
-------	----	-------------------	-------------	-----	------	----	----------	-----------------	---

DIN RAIL CLIP



DEDB	N/A	Black	PA66 UL94-V0 Flame Retardant	N/A	N/A	N/A	N/A	N/A	Snap-On combi foot din rail mounting bracket in black PA66 fits DE01-DE04
DEDG	N/A	Grey	PA66 UL94-V0 Flame Retardant	N/A	N/A	N/A	N/A	N/A	Snap-On combi foot din rail mounting bracket in grey PA66 fits DE01-DE04

FLANGE BRACKET



DEFB	N/A	Black	PA66 UL94-V0 Flame Retardant	N/A	N/A	N/A	N/A	N/A	Snap-On mounting bracket in Black PA66 fits DE01-DE04 2xM3 fixing holes
DEFG	N/A	Grey	PA66 UL94-V0 Flame Retardant	N/A	N/A	N/A	N/A	N/A	Snap-On mounting bracket in Grey PA66 fits DE01-DE04 2xM3 fixing holes

LEGENDS

Product Code	IP rating	Colour (Cover/Base)	Material	Size	H (mm)	W (mm)	D (mm)	Legend	Description
NCU-61-01	N/A	Silver	Self-Adhesive Plastic	N/A	18	18	18	On	Legend for use with DE Enclosures
NCU-61-02	N/A	Silver		N/A	18	18	18	Off	
NCU-61-03	N/A	Silver		N/A	18	18	18	Start	
NCU-61-04	N/A	Silver		N/A	18	18	18	Stop	
NCU-61-05	N/A	Silver		N/A	18	18	18	Fwd	
NCU-61-06	N/A	Silver		N/A	18	18	18	Rev	
NCU-61-07	N/A	Silver		N/A	18	18	18	Up	
NCU-61-08	N/A	Silver		N/A	18	18	18	Down	
NCU-61-09	N/A	Silver		N/A	18	18	18	Fast	
NCU-61-10	N/A	Silver		N/A	18	18	18	Slow	
NCU-61-11	N/A	Silver		N/A	18	18	18	Open	
NCU-61-12	N/A	Silver		N/A	18	18	18	Close	
NCU-61-13	N/A	Silver		N/A	18	18	18	Reset	
NCU-61-14	N/A	Silver		N/A	18	18	18	Em.Stop	
NCU-61-15	N/A	Silver		N/A	18	18	18	I O	
NCU-61-16	N/A	Silver		N/A	18	18	18	On/Off	
NCU-61-17	N/A	Silver		N/A	18	18	18	Start/Stop	
NCU-61-18	N/A	Silver		N/A	18	18	18	Fwd/Rev	
NCU-61-19	N/A	Silver		N/A	18	18	18	Up/Down	
NCU-61-20	N/A	Silver		N/A	18	18	18	Fast/Slow	
NCU-61-21	N/A	Silver		N/A	18	18	18	Open/Close	
NCU-61-22	N/A	Silver		N/A	18	18	18	O I	
NCU-61-23	N/A	Silver		N/A	18	18	18	Off/On	
NCU-61-24	N/A	Silver		N/A	18	18	18	Stop/Start	
NCU-61-25	N/A	Silver		N/A	18	18	18	Rev/Fwd	
NCU-61-26	N/A	Silver		N/A	18	18	18	Down/Up	
NCU-61-27	N/A	Silver		N/A	18	18	18	Slow/Fast	
NCU-61-28	N/A	Silver		N/A	18	18	18	Close/Open	
NCU-61-29	N/A	Silver		N/A	18	18	18	Rev	
NCU-61-30	N/A	Silver		N/A	18	18	18	Rev/Fwd	



CUSTOMISED CONTROL STATIONS ALSO AVAILABLE. PLEASE ASK FOR DETAILS.

22MM SWITCHES & PILOT LAMPS

Features:

- Non Illuminated push button switches available with 12 different heads.
- All switches complete with 1 N/O and 1 N/C contact blocks.
- Mechanical life - 1 million operations.
- Contact material - Silver Bifurcated and serrated.
- Contact rating - AC12 Resistive/AC15 Electromagnetic - 240V (3A)/415V (1.5A).
- Choice of cap colours.
- Insulation resistance - >100MΩ @ 500VDC.
- Different voltage ratings are available.
- Operating temperature -10°C to +65°C.



22MM LED PILOT LAMPS



Product Code	Suffix x	Suffix y	IP Rating	Colour	Description
DLD22-xy	x = (R)ed (G)reen (Y)ellow (W)hite (S)Blue	y = Lamp Volt (A)AC/DC 24V (E)AC/DC 110V (I)AC/DC 240V (M)AC 440V	66	Red/Green/Yellow/White/Blue	Mono block, flush head
DPL22-xy			66	Red/Green/Yellow/White/Blue	Round head, complete with BA9 LED lamp

22MM PUSH BUTTONS - NON-ILLUMINATED



DPB22-D11x	x = (R)ed (G)reen (Y)ellow (W)hite (S)Blue	N/A	54	Red/Green	Double, momentary action
DPB22-E11x		N/A	66	Red/Green/Yellow/Black/White/Blue	Momentary, elevated head
DPB22-F11x		N/A	66	Red/Green/Yellow/Black/White/Blue	Momentary, flush head
DPB22-H11x		N/A	66	Red	"E-Stop" Push/Pull, twist to release, EN418 fail safe, 40mm mushroom head
DPB22-K11x		N/A	56	Red	E-Stop, key to release, EN418 fail safe, 40mm mushroom head
DPB22-L11x		N/A	66	Red/Green/Yellow/Black/White/Blue	Latching, flush head
DPB22-M11x		N/A	56	Red/Green/Yellow	Momentary, 40mm mushroom head
DPB22-P11x		N/A	66	Red/Green/Yellow/White/Blue	Latching, elevated head
DPB22-R11x		N/A	56	Red	"E-Stop", twist to release, EN418 fail safe, 40mm mushroom head
DPB22-S11x		N/A	56	Red	"E-Stop" Push/Pull, twist to release, EN418 fail safe, 35mm mushroom head
DPB22-T11x		N/A	66	Red	New "Emergency Stop", mushroom head twist to release

22MM PUSH BUTTONS - LED ILLUMINATED

DLB22-D11xy	x = (R)ed (G)reen (Y)ellow (W)hite (S)Blue	y = Lamp Volt (A)AC/DC 24V (E)AC/DC 110V (I)AC/DC 240V	54	Red/Green	Double, momentary action	
DLB22-E11xy			66	Red/Green/Yellow/White	Momentary, elevated head	
DLB22-F11xy			66	Red/Green/Yellow/White	Momentary, flush head	
DLB22-L11xy			66	Red/Green/Yellow/White	Latching, flush head	
DLB22-M11xy			56	Red/Green/Yellow	Momentary, 40mm mushroom head	
DLB22-P11xy			66	Red/Green/Yellow/White	Latching, elevated head	
DLB22-R11xy			56	Red	"E-Stop", EN418 fail safe, 40mm mushroom head	
DLB22-T11xy			N/A	66	Red	New illuminated "Emergency Stop", mushroom head twist to release

OTHER SWITCH STYLES AVAILABLE

22MM SELECTOR/KEY SWITCH - LED ILLUMINATED



- IP56
- Selector switch
- Normal shaft size
- 2 & 3 position



- IP56
- Selector switch
- Long shaft size
- 2 positions



- IP56
- Selector switch
- Long shaft size
- 3 positions

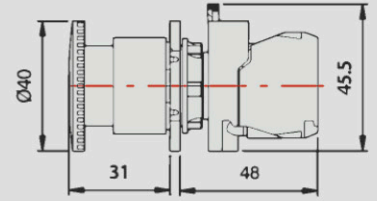
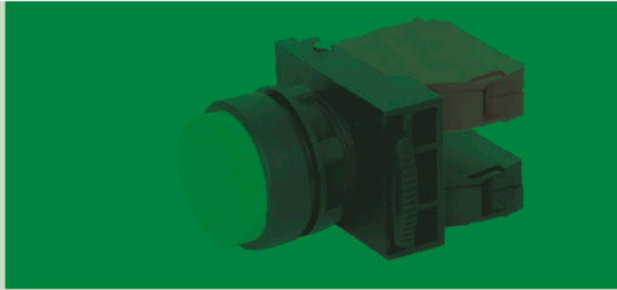
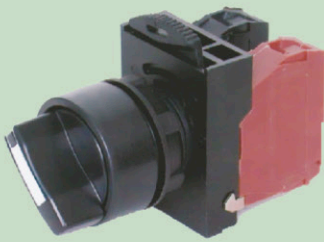

22MM SELECTOR / KEY SWITCH - NON ILLUMINATED



Product Code	Suffix x	Suffix y	IP Rating	Colour	Description
DSS22-K111B		N/A	56	Black	2 position, spring return, key
DSS22-K211B		N/A	56	Black	2 position, maintained, key
DSS22-K011B		N/A	56	Black	3 position, spring return, key
DSS22-K311B		N/A	56	Black	3 position, maintained, key
DSS22-S111B		N/A	56	Black	2 position selector, spring return, short lever
DSS22-S211B		N/A	56	Black	2 position selector, maintained, short lever
DSS22-S011B	Black	N/A	56	Black	3 position selector, spring return, short lever
DSS22-S311B		N/A	56	Black	3 position selector, short lever
DSS22-L111B		N/A	56	Black	2 position selector, spring return, long lever
DSS22-L211B		N/A	56	Black	2 position selector, maintained, long lever
DSS22-L011B		N/A	56	Black	3 position selector, spring return, long lever
DSS22-L311B		N/A	56	Black	3 position selector, long lever

BUZZERS



Product Code	Button Head Material	Body Material	Locknut Material	Temp Rating	Panel Hole Size (mm)	IP Rating	Description
DBZ22-RA				-10°C to +65°C	22.5	66	Pilot lamp flush head, red cap AC,DC24V
DBZ22-RE	Polycarb. VO	PA66 + 15% GF-VO	PA66 V2 + 15%GF	-10°C to +65°C	22.5	66	Pilot lamp flush head, red cap AC220-240V
DBZ22-RI				-10°C to +65°C	22.5	66	Pilot lamp flush head, red cap AC100-120V

ACCESSORIES



DCB-01							N/C contact block (1b)
DCB-10							N/O contact block (1a)
DM01-0Y					Yellow		Yellow shroud
DM01-0W					White		White shroud
DPB22-R01C					Yellow		"Emergency Stop" Yellow legend plate
DPPB22-01C					Black		Legend holder
DPB22-xx						xx = (01)On, (02)Off, (03)Stop, (04)Start, (05)Fwd, (06)Rev, (07)Up, (08)Down, (09)Run, (10)Off On, (11)OI, (12) On Off On, (13) Fwd Off Rev, (14) Man Off Auto, (50) Blank	Standard legend label
DBA9-xy	x = (R)ed (G)reen (Y)ellow (W)hite (S)Blue	y = Lamp Volt (A)AC/DC 24V (E)AC/CD 110V (I)AC/DC 240V			Red/Green/Yellow/White/Blue		BA9 LED Lamp
DBA9-T2							BA9 Lamp extraction tool
DBA9-H							Lampholder
DB22-H06L	Clear	Polycarbonate			Clear		Transparent padlock cover
DPB22-D06					Clear		Transparent rubber boot for rectangular switch
DPPB-P06							Rubber cap for round push button
DPPB-02T					Grey		Fixing nut tool

CONTROL STATIONS



Reg. Design

EN

Features:

- Customised control station service available - please ask for details.
- Insulation resistance - >100MΩ @ 500VDC.
- Enclosures sealed up to IP66 depending on Switch IP rating
- Unique snap on Din Rail and Flange brackets.
- Dust & waterproof for short-term submersion.
- 4 sizes available! Accepting 1 - 4 push button switches.
- 2 contact blocks fitted as standard (1 x N/O and 1 x N/C).
- Different voltage ratings are available.
- Contact material - Silver Bifurcated and serrated.
- Operating Temperature -10°C to +65°C.
- Contact rating - AC12 Resistive/AC15 Electromagnetic - 240V (3A)/415V (1.5A).
- Mechanical life - 1 million operations.

SINGLE CONTROL STATIONS

EMERGENCY STOP



Product Code	IP Rating	Colour (Cover/Base)	Material	H (mm)	W (mm)	D (mm)	Description
1DE.01.01AG	66	Yellow/Grey	ABS-UL94-HB	80	73	53*	"Emergency Stop" EN418 fail safe, twist to release
1DE.01.01AB	66	Yellow/Black		80	73	53*	



EMERGENCY STOP KEY

1DE.01.03AG	56	Yellow/Grey	ABS-UL94-HB	80	73	53*	"Emergency Stop", key release
1DE.01.03AB	56	Yellow/Black		80	73	53*	



PUSH BUTTON

1DE.01.04AB	66	Grey/Black	ABS-UL94-HB	80	73	53*	Single "Stop" push button, Red actuator
1DE.01.04AG	66	Grey/Grey		80	73	53*	
1DE.01.06AB	66	Grey/Black	ABS-UL94-HB	80	73	53*	Single "Start" push button, Green actuator
1DE.01.06AG	66	Grey/Grey		80	73	53*	



SELECTOR/KEY SWITCH

1DE.01.08AB	56	Grey/Black	ABS-UL94-HB	80	73	53*	2 - Position Selector Switch
1DE.01.08AG	56	Grey/Grey		80	73	53*	
1DE.01.09AB	56	Grey/Black	ABS-UL94-HB	80	73	53*	2 - Position Key Switch
1DE.01.09AG	56	Grey/Grey		80	73	53*	



DOUBLE PUSH BUTTON

1DE.01.10AB	56	Grey/Black	ABS-UL94-HB	80	73	53*	Double push button - Stop/Start (O/I)
1DE.01.10AG	56	Grey/Grey		80	73	53*	



PALM/FOOT SWITCH

1DE.SP.21NR	66	Grey/Black	ABS-UL94-HB	85	85	102**	Red Palm/Foot Push Button
1DE.SP.21NG	66	Grey/Black		85	85	102**	Green Palm/Foot Push Button
1DE.SP.21NB	66	Grey/Black		85	85	102**	Black Palm/Foot Push Button

2 SWITCH CONTROL STATIONS

EMERGENCY STOP & 1 PUSH BUTTON



1DE.02.01AG	56	Yellow/Grey	ABS-UL94-HB	80	106	53	"Emergency Stop" EN418 fail safe, twist to release. Single "Start" push button, Green actuator.
1DE.02.01AB	56	Yellow/Black		80	106	53	

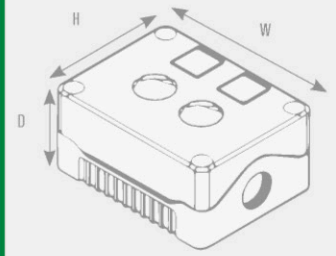

EMERGENCY STOP & 2 PUSH BUTTONS



Product Code	IP Rating	Colour (Cover/Base)	Material	H (mm)	W (mm)	D (mm)	Description
1DE.03.01AG	56	Grey/Grey	ABS-UL94-HB	80	139	53	"Emergency Stop" EN418 fail safe, twist to release Double "Up/Down" push buttons, Green actuators
1DE.03.01AB	56	Grey/Black		80	139	53	

2 & 3 PUSH BUTTONS



1DE.02.02AG	66	Grey/Grey	ABS-UL94-HB	80	106	53	Double push button - "Start" push button, Green actuator & "Stop" push button, Red actuator
1DE.02.02AB	66	Grey/Black		80	106	53	
1DE.03.02AG	66	Grey/Grey		80	106	53	Double push button - Fwd/Rev push buttons, Green actuators & "Stop" push button, Red actuator
1DE.03.02AB	66	Grey/Black		80	106	53	

ACCESSORIES

CABLE GLANDS



50.620 PA7035/FD	68	Grey	Polyamide 6	29.2	10	N/A	Grey Cable Gland POLY6 IP68, Fits All Sizes Of Enclosures, M20x1.5mm Thread Glands
50.620 PASW/FD	68	Black		29.2	10	N/A	Black Cable Gland POLY6 IP68, Fits All Sizes Of Enclosures, M20x1.5mm Thread Glands

DIN RAIL CLIP AND FLANGE MOUNTING BRACKETS



DE0DB	N/A	Black	PA66 UL94-V0 Flame Retardant	N/A	N/A	N/A	Snap-On Combi Foot DIN Rail Mounting Bracket In Black PA66 Fits DE01-DE04
DE0DG	N/A	Grey		N/A	N/A	N/A	Snap-On Combi Foot DIN Rail Mounting Bracket In Grey PA66 Fits DE01-DE04
DEFB	N/A	Black		N/A	N/A	N/A	Snap-On Mounting Bracket In Black PA66 Fits DE01-DE04 2xM3 Fixing Holes
DEFG	N/A	Grey		N/A	N/A	N/A	Snap-On Mounting Bracket In Grey PA66 Fits DE01-DE04 2xM3 Fixing Holes

MISCELLANEOUS



DB22-H06L	65	Transparent	Polycarbonate	N/A	N/A	N/A	Transparent padlock cover
DPB22-D06	N/A	Transparent	Rubber	N/A	N/A	N/A	Transparent rubber boot for rectangular switch
DPPB-P06	N/A	Transparent	Rubber	N/A	N/A	N/A	Rubber cap for round push button
DPPB-02T	N/A	Grey		N/A	N/A	N/A	Fixing Nut Tool
DM01-OY	N/A	Yellow		N/A	N/A	N/A	Yellow Shroud with hole
DM01-OW	N/A	White		N/A	N/A	N/A	White Shroud with hole

SWITCHES

ISOLATOR SWITCHES

IP67 AC ISOLATION SWITCH SPECIFICATION

Model	DE1S.04.20AC		DE1S.04.25AC		DE1S.04.32AC		DE1S.04.40AC		DE1S.04.63AC	
Rated insulation voltage (V)	690		690		690		690		690	
Rated carry current (A)	20		25		32		40		63	
Rated operating current (A) AC-23A	15		17.9		22		30		43	
Rated operating current (A) AC-3	11		12.7		15		22		36	
Rated voltage	240	440	240	440	240	440	240	440	240	440
Rated power control (kW) AC-23A	3.7	5.5	4.5	7.8	5.5	11	7.5	15	9	22
Rated power control (kW) AC-3	2.7	3.7	3.2	5.3	4	7.5	5.5	11	8	18.5
UL-CSA	240	440	240	440	240	440	240	440	240	440
Motor load (HP)	2	3	3.3	5.9	5	10	7.5	15	10	20
Rated current within (A)	180		215		264		360		516	
Connect wires (mm ²)	1.25-5.5		1.56-9.04		2-14		2-44		2-38	
Screw torque (N . m)	0.8(8.16kgf.cm)				1.2(12.24kgf.cm)				1.2(12.24kgf.cm)	
Approvals										

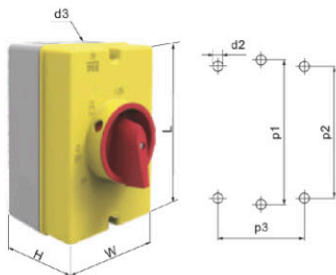



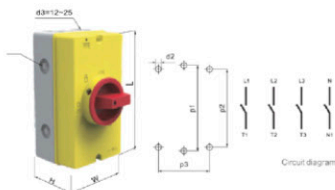



Model	Dimensions				Holes Dimensions			
	d3	W	H	L	p1	p2	p3	d2
20		98	80	145	134	115	81	4.2
25		98	80	145	134	115	81	4.2
32		98	80	145	134	115	81	4.2
40		98	80	145	134	115	81	4.2



Model	Dimensions					Holes Dimensions			
	d3	d4	W	H	L	p1	p2	p3	d2
63 and DC range	25	20	98	81	180	169	155	80	4.2

DC ISOLATION SWITCH SPECIFICATION

Main Parameters			DE1S.04.16DC	DE1S.04.25DC	DE1S.04.32DC
Rated insulation voltage	Ui		1500V	1500V	1500V
Rated thermal current	Ithe		25A	25A	32A
Rated impulse withstand voltage	Uimp		8000V	8000V	8000V
Rated short-time withstand current (1s)	Icw	2,4,6,8	800A	900A	1000A
		2H, 3H, 4H	1300A	1500A	1700A
Rated short-circuit making capacity	Icm	2,4,6,8	800A	900A	1000A
		2H, 3H, 4H	1300A	1500A	1700A
Rated conditional short-circuit current	Icc		5000A	5000A	5000A
Max. fuse size	gL(gG)		40A	63A	80A
Max. cable cross sections					
Solid or standard			4-16mm ²	4-16mm ²	4-16mm ²
Flexible			4-10mm ²	4-10mm ²	4-10mm ²
Flexible			4-10mm ²	4-10mm ²	4-10mm ²
Torque					
Tightening torque terminal screws M4			1.2-1.3Nm	1.2-1.3Nm	1.2-1.3Nm
Tightening torque panel mounting screws ST4.2			NA	NA	NA
Tightening torque knob screws M3			2.0-2.3Nm	2.0-2.3Nm	2.0-2.3Nm
Tightening torque knob screws M3			0.5-0.7Nm	0.5-0.7Nm	0.5-0.7Nm
Switching on or off torque			0.9-1.3Nm	0.9-1.3Nm	0.9-1.3Nm
Power loss per switch Max.					
2			1W	2W	3W
2H4			2W	4W	6W
3H6			3W	6W	9W
4H8			4W	8W	12W
General parameters					
Mechanical life				10.000	
Number of DC poles				4	
Distance of contacts (per pole)				8mm	
Operation temperature				-25°C + 70°C	
Storage temperature				-40°C + 70°C	
Pollution degree				2	
Over voltage category				I to III	
IP rating of shaft and mounting				IP67	
Weight		2		0.14kg	
		2H4		0.207g	
		3H6		0.26kg	
		4H8		0.31kg	
Approvals			 	 	 

NYLON PERFECT METRIC IP68 CABLE GLANDS INC. KWIK FIX & VENTING ELEMENTS

Features:

- Up to IP68 at 5 Bar.
- Includes Pg/Metric Perfect Range where Sealing range and dome nut dimensions are identical to pg-series.
- Reducing cable range versions included.
- PA6 V0 options available.
- Temp Rating of -20°C to +100°C.



KWIK FIX IP68 METRIC CABLE GLANDS

Features:

- IP68.
- Temp range -20°C to +100°C.
- Quick and easy installation without special tools.
- Assemble from one side only no separate locknut.
- Saves time so saves money.
- Wall thickness 1 - 4mm.

Patented



IP68 METRIC PERFECT NYLON CABLE GLAND

Part Code	Colour	Material	Size	H (mm)	ØC (mm)
K341-1016-00	Grey RAL 7035	Polyamide PA6 V2	M16	38.5	5 - 10
K341-1020-00	Grey RAL 7035	Polyamide PA6 V2	M20	42.5	8 - 13
K341-1025-00	Grey RAL 7035	Polyamide PA6 V2	M25	48	11 - 17
K341-1016-01	Grey RAL 7001	Polyamide PA6 V2	M16	38.5	5 - 10
K341-1020-01	Grey RAL 7001	Polyamide PA6 V2	M20	42.5	8 - 13
K341-1025-01	Grey RAL 7001	Polyamide PA6 V2	M25	48	11 - 17
K341-1016-02	Black RAL 9005	Polyamide PA6 V2	M16	38.5	5 - 10
K341-1020-02	Black RAL 9005	Polyamide PA6 V2	M20	42.5	8 - 13
K341-1025-02	Black RAL 9005	Polyamide PA6 V2	M25	48	11 - 17

VENTING ELEMENTS / BREATHER PLUGS

Waterproof Enclosures with high protection grades IP67 or IP68 for outdoor use are not automatically sealed against vapour and humid air. To avoid negative pressure, high humidity and condensation inside the enclosure continuous ventilation and pressure equilibrium is necessary. This protection can be achieved by using a venting element which is quick and easy to install.

The body of the venting element is made from a flameproof polyamide PA6 which contains a high-quality, breathable and watertight PES-membrane. The unit provides a continuous pressure exchange and ventilation between the enclosure and its surroundings whilst ensuring protection against humidity and achieving a high IP rating of up to IP69K.

Stainless steel versions available – please ask for details

Tech. Spec:

- Typical air flow >400 ml/min/cm² at Δp = 0.07 bar.
- Water entry pressure ≥ 0.83.
- Temperature range -40°C to +100°C.
- Protection grade IP66 / IP68 - 0,6 bar (60 min.) / IP69K.

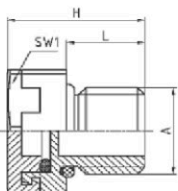

Part Code	Colour	Material	IP Rating	Thread Size	Thread Length	O/A Length	A/F Dim'n
JDAE12PA7035	Grey RAL 7035	PA6/PES	Up to 69K	M12	10	17.8	17
JDAE20PA7035	Grey RAL 7035	PA6/PES	Up to 69K	M20	10	21.6	27
JDAE40PA7035	Grey RAL 7035	PA6/PES	Up to 69K	M40	18	35.6	50
JDAE12PA/SW	Black RAL 9005	PA6/PES	Up to 69K	M12	10	17.8	17
JDAE40PA/SW	Black RAL 9005	PA6/PES	Up to 69K	M40	18	35.6	50
JDAE12ES4305	Silver	Stainless Steel 1.4305	Up to 69K	M12	10	17.8	17

OTHER STYLES OF GLAND ARE AVAILABLE

KRALLEN CABLE GLAND:



Features:

- IP65 rated.
- Polyamide PA6 GF30.
- Sizes M12 - M40.
- Temp Rating of -30°C to +100°C.
- Cable Range 4 - 6mm to 18 - 24mm.

FAVORIT NYLON CABLE GLANDS:



Features:

- IP55 rated.
- Polyamide PA6 GF30.
- Sizes M12 - M40.
- Temp Rating of -30°C to +80°C.
- Cable Range 5.5 - 7.5mm to 18 - 25mm.

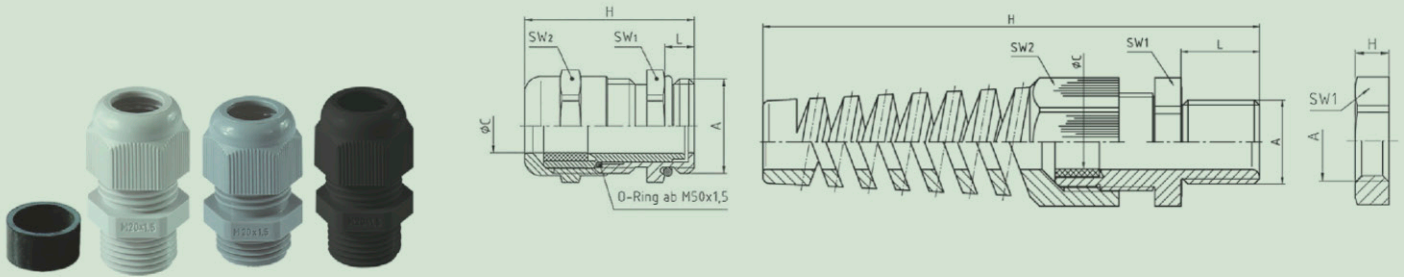

IP68 METRIC PERFECT NYLON CABLE GLAND



Part Code	Colour	Material	Size	H (mm)	L (mm)	ØC (mm)
50.612 PA7001	Grey RAL 7001	Nylon PA6	M12	31	8	3 - 6
50.616 PA7001		Nylon PA6	M16	35.5	8	5 - 10
50.620 PA7001		Nylon PA6	M20	36	8	8 - 13
50.625 PA7001		Nylon PA6	M25	43	8	11 - 17
50.632 PA7001		Nylon PA6	M32	50	10	15 - 21
50.640 PA7001		Nylon PA6	M40	51	10	19 - 28
50.650 PA7001		Nylon PA6	M50	61.5	12	27 - 35
50.663 PA7001	Nylon PA6	M63	65.5	12	32 - 42	
50.612 PA7035	Grey RAL 7035	Nylon PA6	M12	31	8	3 - 6
50.616 PA7035		Nylon PA6	M16	35.5	8	5 - 10
50.620 PA7035		Nylon PA6	M20	36	8	8 - 13
50.625 PA7035		Nylon PA6	M25	43	8	11 - 17
50.632 PA7035		Nylon PA6	M32	50	10	15 - 21
50.640 PA7035		Nylon PA6	M40	51	10	19 - 28
50.650 PA7035		Nylon PA6	M50	61,5	12	27 - 35
50.663 PA7035	Nylon PA6	M63	65,5	12	32 - 42	
50.612 PA/SW	Black RAL 9005	Nylon PA6	M12	31	8	3 - 6
50.616 PA/SW		Nylon PA6	M16	35.5	8	5 - 10
50.620 PA/SW		Nylon PA6	M20	36	8	8 - 13
50.625 PA/SW		Nylon PA6	M25	43	8	11 - 17
50.632 PA/SW		Nylon PA6	M32	50	10	15 - 21
50.640 PA/SW		Nylon PA6	M40	51	10	19 - 28
50.650 PA/SW		Nylon PA6	M50	61.5	12	27 - 35
50.663 PA/SW	Nylon PA6	M63	65.5	12	32 - 42	

CONUS SIMPLE & MULTIPLE SEALING RING



Features:

- IP65 rated.
- Polyamide PA6 GF30.
- Sizes M12 - M63.
- Temp Rating of -30°C to +80°C.
- RAL 7035.
- Simple Sealing ring cable range 6 - 8mm to 43 - 44mm.
- Multiple sealing ring cable range 4 - 8mm to 35 - 45mm.

METRIC NYLON CABLE GLANDS FOR FLAT CABLE:



Features:

- IP55 rated.
- Material Polyamide PA6 GF30.
- Sizes M25 - M63.
- Temp Rating of -30°C to +80°C.
- Cable range 5x15mm to 16x45mm.

NYLON PERFECT METRIC IP68 CABLE GLANDS INC. KWIK FIX & VENTING ELEMENTS



IP68 PERFECT NYLON CABLE GLAND WITH REDUCING INSERT

Part Code	Colour	Material	Size	H (mm)	L (mm)	ØC (mm)
50.612 PA/R	Grey RAL 7001	Nylon PA6	M12	31	8	2 - 5
50.616 PA/R		Nylon PA6	M16	35.5	8	3 - 10
50.620 PA/R		Nylon PA6	M20	36	8	5 - 13
50.625 PA/R		Nylon PA6	M25	43	8	8 - 17
50.632 PA/R		Nylon PA6	M32	50	10	12 - 21
50.640 PA/R		Nylon PA6	M40	51	10	16 - 28
50.650 PA/R		Nylon PA6	M50	61.5	12	21 - 35
50.663 PA/R	Nylon PA6	M63	65.5	12	27 - 48	
50.612 PA/R7035	Grey RAL 7035	Nylon PA6	M12	31	8	2 - 5
50.616 PA/R7035		Nylon PA6	M16	35.5	8	3 - 10
50.620 PA/R7035		Nylon PA6	M20	36	8	5 - 13
50.625 PA/R7035		Nylon PA6	M25	43	8	8 - 17
50.632 PA/R7035		Nylon PA6	M32	50	10	12 - 21
50.640 PA/R7035		Nylon PA6	M40	51	10	16 - 28
50.650 PA/R7035		Nylon PA6	M50	61.5	12	21 - 35
50.663 PA/R7035	Nylon PA6	M63	65.5	12	27 - 48	
50.612 PA/RSW	Black RAL 9005	Nylon PA6	M12	31	8	2 - 5
50.616 PA/RSW		Nylon PA6	M16	35.5	8	3 - 10
50.620 PA/RSW		Nylon PA6	M20	36	8	5 - 13
50.625 PA/RSW		Nylon PA6	M25	43	8	8 - 17
50.632 PA/RSW		Nylon PA6	M32	50	10	12 - 21
50.640 PA/RSW		Nylon PA6	M40	51	10	16 - 28
50.650 PA/RSW		Nylon PA6	M50	61.5	12	21 - 35
50.663 PA/RSW	Nylon PA6	M63	65.5	12	27 - 48	

IP66 PERFECT NYLON CABLE GLAND FOR FLAT PROFILE CABLE

50.620 PA7035FK1	Grey RAL 7035	Nylon PA6	M20	36	8	5x12 max, 2x8 min
50.625 PA7035FK1		Nylon PA6	M25	43	8	6x16.3 max, 2x10 min
50.632 PA7035FK1		Nylon PA6	M32	50	10	9x20 max, 3x12 min
50.640 PA7035FK1		Nylon PA6	M40	51	10	10x27 max, 3x19 min
50.650 PA7035FK1		Nylon PA6	M50	61.6	12	13x34 max, 4x23 min
50.663 PA7035FK1		Nylon PA6	M63	65.5	12	15x46 max, 6x32 min
50.620 PASWFK1		Black RAL 9005	Nylon PA6	M20	36	8
50.625 PASWFK1	Nylon PA6		M25	43	8	6x16.3 max, 2x10 min
50.632 PASWFK1	Nylon PA6		M32	50	10	9x20 max, 3x12 min
50.640 PASWFK1	Nylon PA6		M40	51	10	10x27 max, 3x19 min
50.650 PASWFK1	Nylon PA6		M50	61.6	12	13x34 max, 4x23 min
50.663 PASWFK1	Nylon PA6		M63	65.5	12	15x46 max, 6x32 min





IP68 PERFECT NYLON CABLE GLAND WITH SPIRAL TOP CABLE PROTECTOR



Part Code	Colour	Material	Size	H (mm)	L (mm)	ØC (mm)
50007M12BSSW	Black RAL 9005	Nylon PA6	M12	63.5	8	3 - 6.5
50011M16BSSW		Nylon PA6	M16	94.5	15	5 - 10
50013M20BSSW		Nylon PA6	M20	101.5	11	6 - 12
50016M20BSSW		Nylon PA6	M20	116	15	10 - 14
50021M25BSSW		Nylon PA6	M25	132.5	15	13 - 18
50007M12PABS	Grey RAL 7001	Nylon PA6	M12	63.5	8	3 - 6.5
50011M16PABS		Nylon PA6	M16	94.5	15	5 - 10
50013M20PABS		Nylon PA6	M20	101.5	11	6 - 12
50016M20PABS		Nylon PA6	M20	116	15	10 - 14
50021M25PABS		Nylon PA6	M25	132.5	15	13 - 18
50007M12BS7035	Grey RAL 7035	Nylon PA6	M12	63.5	8	3 - 6.5
50011M16BS7035		Nylon PA6	M16	94.5	15	5 - 10
50013M20BS7035		Nylon PA6	M20	101.5	11	6 - 12
50016M20BS7035		Nylon PA6	M20	116	15	10 - 14
50021M25BS7035		Nylon PA6	M25	132.5	15	13 - 18



NYLON PERFECT METRIC IP68 RAILWAY CERTIFIED CABLE GLANDS PA6 V0

This range of nylon metric cable glands is available in Grey RAL 7032 and Black RAL 9005. Manufactured from Polyamide PA6 V0 with a Polychloroprene-Nitrile rubber sealing ring this product range is one of a select few

nylon glands that has passed the railway approval test in accordance with NF F 16-101. Qualifying for I2 and F2 classification (no fire at +850 °C and minimal development of flue gases) this ensures that these

glands will give maximum fire protection which is essential in the confined space of a moving train.

Features:

- Temperature range -20°C to +100°C.
- +960°C glow wire test at 0.8mm wall thickness.
- IP68 rated, Polyamide PA6 V0.
- I2/F2 approval according to French standard NFF 16-101.



RAILWAY CERTIFIED IP68 CABLE GLANDS



Product Code	Colour	Material	Sealing Ring Material	Size	H (mm)	Thread Length	Clamping Range (mm)		
50.612 PA/FL	Grey RAL 7032	Polyamide PA6 V0	Polychloroprene-Nitrile rubber CR/NBR	M12	31	8	3 to 6		
50.616 PA/FL				M16	35.5	8	5 to 10		
50.620 PA/FL				M20	36	8	8 to 13		
50.625 PA/FL				M25	43	8	11 to 17		
50.632 PA/FL				M32	50	10	15 to 21		
50.640 PA/FL				M40	51	10	19 to 28		
50.650 PA/FL				M50	61.5	12	27 to 35		
50.663 PA/FL	M63			65.5	12	32 to 42			
50.612 PA/FLSW	Black RAL 9005			Polyamide PA6 V0	Polychloroprene-Nitrile rubber CR/NBR	M12	31	8	4 to 6
50.616 PA/FLSW						M16	35.5	8	6 to 10
50.620 PA/FLSW						M20	36	8	9 to 13
50.625 PA/FLSW						M25	43	8	12 to 17
50.632 PA/FLSW						M32	50	10	16 to 21
50.640 PA/FLSW						M40	51	10	20 to 28
50.650 PA/FLSW		M50	61.5			12	28 to 35		
50.663 PA/FLSW	M63	65.5	12			33 to 42			



NYLON PERFECT METRIC IP66 ATEX GLANDS

Features:

- Polyamide PA6.
- IP66.
- Equipment group: II.
- Category/Zone: 2G and 2D/1, 2, 21, 22.

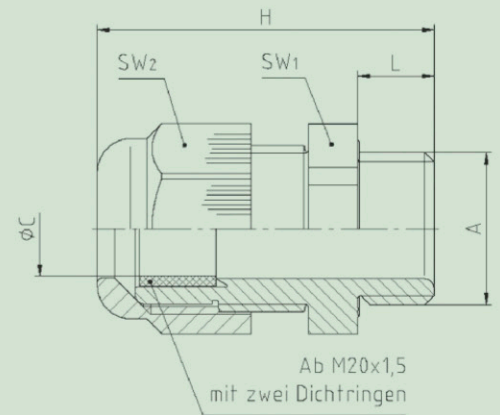

IP66 PERFECT NYLON EX-CABLE GLAND - BLACK



Product Code	Colour	Size	H (mm)	L (mm)	ØC (mm)	Temp Rating
GHG9601955R0001	Black RAL 9005	M12	31	8	5 - 7	-20°C to +70°C
GHG9601955R0002		M16	35.5	8	7 - 10	-20°C to +70°C
GHG9601955R0003		M20	37	8	9.5 - 13	-20°C to +70°C
GHG9601955R0004		M25	43	8	13.5 - 17.5	-20°C to +70°C
GHG9601955R0005		M32	50	10	17.5 - 21	-55°C to +70°C
GHG9601955R0006		M40	51	10	22 - 28	-55°C to +70°C
GHG9601955R0007		M50	61.5	12	28 - 35	-55°C to +70°C
GHG9601955R0008		M63	65.5	12	36 - 48	-55°C to +70°C

IP66 PERFECT NYLON EX-CABLE GLAND WITH RAL 5015 CAP - BLACK/BLUE



Product Code	Colour	Size	H (mm)	L (mm)	ØC (mm)	Temp Rating
GHG9601955R0101	Black RAL 9005 + Blue RAL 5015 Cap	M12	35	12	5 - 7	-20°C to +70°C
GHG9601955R0102		M16	39.5	12	7 - 10	-20°C to +70°C
GHG9601955R0103		M20	42	13	9.5 - 13	-20°C to +70°C
GHG9601955R0104		M25	48	13	13.5 - 17.5	-20°C to +70°C
GHG9601955R0105		M32	55	15	17.5 - 21	-55°C to +70°C
GHG9601955R0106		M40	56	15	22 - 28	-55°C to +70°C
GHG9601955R0107		M50	66.5	16	28 - 35	-55°C to +70°C
GHG9601955R0108		M63	69.5	16	36 - 48	-55°C to +70°C

IP66 PERFECT NYLON EX-CABLE GLAND FOR LOW TEMPERATURE - BLACK



Product Code	Colour	Size	H (mm)	L (mm)	ØC (mm)	Temp Rating
GHG9601955R0001	Black RAL 9005	M12	31	8	5 - 7	-20°C to +70°C
GHG9601955R0002		M16	35.5	8	7 - 10	-20°C to +70°C
GHG9601955R0003		M20	37	8	9.5 - 13	-20°C to +70°C
GHG9601955R0004		M25	43	8	13.5 - 17.5	-20°C to +70°C
GHG9601955R0005		M32	50	10	17.5 - 21	-55°C to +70°C
GHG9601955R0006		M40	51	10	22 - 28	-55°C to +70°C
GHG9601955R0007		M50	61.5	12	28 - 35	-55°C to +70°C
GHG9601955R0008		M63	65.5	12	36 - 48	-55°C to +70°C

IP66 PERFECT NYLON EX-CABLE GLAND FOR LOW TEMPERATURE WITH RAL 5015 CAP - BLACK/BLUE



Product Code	Colour	Size	H (mm)	L (mm)	ØC (mm)	Temp Rating
GHG9601955R0101	Black RAL 9005 + Blue RAL 5015 Cap	M12	35	12	5 - 7	-20°C to +70°C
GHG9601955R0102		M16	39.5	12	7 - 10	-20°C to +70°C
GHG9601955R0103		M20	42	13	9.5 - 13	-20°C to +70°C
GHG9601955R0104		M25	48	13	13.5 - 17.5	-20°C to +70°C
GHG9601955R0105		M32	55	15	17.5 - 21	-55°C to +70°C
GHG9601955R0106		M40	56	15	22 - 28	-55°C to +70°C
GHG9601955R0107		M50	66.5	16	28 - 35	-55°C to +70°C
GHG9601955R0108		M63	69.5	16	36 - 48	-55°C to +70°C

NYLON METRIC GLAND ACCESSORIES & LOCKNUTS

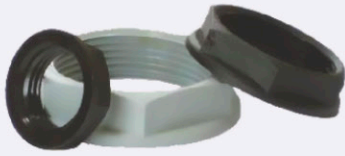

LOCKNUTS

Part Code	Colour	Size	H (mm)	L (mm)	ØC (mm)	IP Rating	Material	Temperature Rating
50.212 PA7001	Grey RAL 7001	M12	5	N/A	N/A	N/A	PA6 GF30	-20°C to +100°C
50.216 PA7001		M16	5	N/A	N/A	N/A	PA6 GF30	-20°C to +100°C
50.220 PA7001		M20	6	N/A	N/A	N/A	PA6 GF30	-20°C to +100°C
50.225 PA7001		M25	6	N/A	N/A	N/A	PA6 GF30	-20°C to +100°C
50.232 PA7001		M32	7	N/A	N/A	N/A	PA6 GF30	-20°C to +100°C
50.240 PA7001		M40	7	N/A	N/A	N/A	PA6 GF30	-20°C to +100°C
50.250 PA7001		M50	8	N/A	N/A	N/A	PA6 GF30	-20°C to +100°C
50.263 PA7001		M63	8	N/A	N/A	N/A	PA6 GF30	-20°C to +100°C
50.212 PA7035	Grey RAL 7035	M12	5	N/A	N/A	N/A	PA6 GF30	-20°C to +100°C
50.216 PA7035		M16	5	N/A	N/A	N/A	PA6 GF30	-20°C to +100°C
50.220 PA7035		M20	6	N/A	N/A	N/A	PA6 GF30	-20°C to +100°C
50.225 PA7035		M25	6	N/A	N/A	N/A	PA6 GF30	-20°C to +100°C
50.232 PA7035		M32	7	N/A	N/A	N/A	PA6 GF30	-20°C to +100°C
50.240 PA7035		M40	7	N/A	N/A	N/A	PA6 GF30	-20°C to +100°C
50.250 PA7035		M50	8	N/A	N/A	N/A	PA6 GF30	-20°C to +100°C
50.263 PA7035		M63	8	N/A	N/A	N/A	PA6 GF30	-20°C to +100°C
50.212 PA/SW	Black RAL 9005	M12	5	N/A	N/A	N/A	PA6 GF30	-20°C to +100°C
50.216 PA/SW		M16	5	N/A	N/A	N/A	PA6 GF30	-20°C to +100°C
50.220 PA/SW		M20	6	N/A	N/A	N/A	PA6 GF30	-20°C to +100°C
50.225 PA/SW		M25	6	N/A	N/A	N/A	PA6 GF30	-20°C to +100°C
50.232 PA/SW		M32	7	N/A	N/A	N/A	PA6 GF30	-20°C to +100°C
50.240 PA/SW		M40	7	N/A	N/A	N/A	PA6 GF30	-20°C to +100°C
50.250 PA/SW		M50	8	N/A	N/A	N/A	PA6 GF30	-20°C to +100°C
50.263 PA/SW		M63	8	N/A	N/A	N/A	PA6 GF30	-20°C to +100°C



METRIC NYLON ACCESSORIES

Features:

- Locknut available in V0 material.
- Thread adaptors have a Temperature Range of -30°C to +100°C.
- Flange Locknuts available.

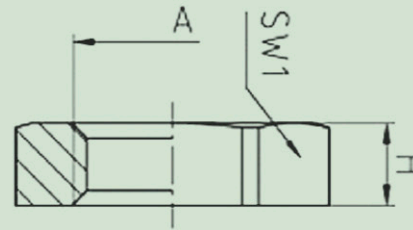

FLANGE LOCKNUTS

Part Code	Colour	Size	H (mm)	L (mm)	SW (mm)	IP Rating	Material	Temperature Rating
DLN16B	Black RAL 9005	M16	7	N/A	N/A	N/A	Nylon 6	
DLN20B		M20	7	N/A	N/A	N/A	Nylon 6	
DLN25B		M25	8	N/A	N/A	N/A	Nylon 6	
DLN16G	Grey RAL 7035	M16	7	N/A	N/A	N/A	Nylon 6	
DLN20G7035		M20	7	N/A	N/A	N/A	Nylon 6	
DLN25G		M25	8	N/A	N/A	N/A	Nylon 6	
DLN16W	White RAL 9010	M16	7	N/A	N/A	N/A	Nylon 6	
DLN20W		M20	7	N/A	N/A	N/A	Nylon 6	
DLN20G7001	Grey RAL 7001	M20	7	N/A	N/A	N/A	Nylon 6	
DLN20R	Flame Red RAL 3000	M20	7	N/A	N/A	N/A	Nylon 6	



METRIC NYLON REDUCING THREAD ADAPTOR

M16M12 PA/SW	Black RAL 9005	M16M12	12	8	24	N/A	PA6	-30°C to +100°C
M20M12 PA/SW		M20M12	12	8	24	N/A	PA6	-30°C to +100°C
M20M16 PA/SW		M20M16	12	8	24	N/A	PA6	-30°C to +100°C
M25M12 PA/SW		M25M12	14	8	29	N/A	PA6	-30°C to +100°C
M25M16 PA/SW		M25M16	14	8	29	N/A	PA6	-30°C to +100°C
M25M20 PA/SW		M25M20	14	8	29	N/A	PA6	-30°C to +100°C
M32M12 PA/SW		M32M12	16	10	36	N/A	PA6	-30°C to +100°C
M32M16 PA/SW		M32M16	16	10	36	N/A	PA6	-30°C to +100°C
M32M20 PA/SW		M32M20	16	10	36	N/A	PA6	-30°C to +100°C
M32M25 PA/SW		M32M25	16	10	36	N/A	PA6	-30°C to +100°C
M40M16 PA/SW		M40M16	16	10	46	N/A	PA6	-30°C to +100°C
M40M20 PA/SW		M40M20	16	10	46	N/A	PA6	-30°C to +100°C
M40M25 PA/SW		M40M25	16	10	46	N/A	PA6	-30°C to +100°C
M40M32 PA/SW		M40M32	16	10	55	N/A	PA6	-30°C to +100°C
M50M20 PA/SW		M50M20	18	12	55	N/A	PA6	-30°C to +100°C
M50M25 PA/SW		M50M25	18	12	55	N/A	PA6	-30°C to +100°C
M50M32 PA/SW		M50M32	18	12	55	N/A	PA6	-30°C to +100°C
M50M40 PA/SW		M50M40	18	12	55	N/A	PA6	-30°C to +100°C
M63M25 PA/SW		M63M25	18	12	68	N/A	PA6	-30°C to +100°C
M63M32 PA/SW		M63M32	18	12	68	N/A	PA6	-30°C to +100°C
M63M40 PA/SW		M63M40	18	12	68	N/A	PA6	-30°C to +100°C
M63M50 PA/SW		M63M50	18	12	68	N/A	PA6	-30°C to +100°C



NYLON METRIC GLAND ACCESSORIES & LOCKNUTS

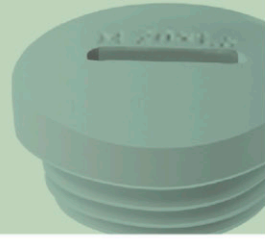

IP65 METRIC NYLON BLANKING PLUG WITH SIMPLE SEALING RING

Part Code	Colour	Size	H (mm)	L (mm)	Ø (mm)	IP Rating	Material	Temperature Rating
10.1215 PAV	Grey RAL 7001	M12	10	6	15	65	PA6	-30°C to +100°C
10.1615 PAV		M16	10.5	6	20	65	PA6	-30°C to +100°C
10.2015 PAV		M20	10.5	6	24	65	PA6	-30°C to +100°C
10.2515 PAV		M25	13	8	30	65	PA6	-30°C to +100°C
10.3125 PAV		M32	13.5	8	37	65	PA6	-30°C to +100°C
10.4015 PAV		M40	14	8	46	65	PA6	-30°C to +100°C
10.5015 PAV		M50	16.5	10	56	65	PA6	-30°C to +100°C
10.6315 PAV		M63	17	12	70	65	PA6	-30°C to +100°C
10.1215 PAV7035	Grey RAL 7035	M12	10	6	15	65	PA6	-30°C to +100°C
10.1615 PAV7035		M16	10.5	6	20	65	PA6	-30°C to +100°C
10.2015 PAV7035		M20	10.5	6	24	65	PA6	-30°C to +100°C
10.2515 PAV7035		M25	13	8	30	65	PA6	-30°C to +100°C
10.3125 PAV7035		M32	13.5	8	37	65	PA6	-30°C to +100°C
10.4015 PAV7035		M40	14	8	46	65	PA6	-30°C to +100°C
10.5015 PAV7035		M50	16.5	10	56	65	PA6	-30°C to +100°C
10.6315 PAV7035		M63	17	12	70	65	PA6	-30°C to +100°C
10.1215 PAVSW	Black RAL 9005	M12	10	6	15	65	PA6	-30°C to +100°C
10.1615 PAVSW		M16	10.5	6	20	65	PA6	-30°C to +100°C
10.2015 PAVSW		M20	10.5	6	24	65	PA6	-30°C to +100°C
10.2515 PAVSW		M25	13	8	30	65	PA6	-30°C to +100°C
10.3125 PAVSW		M32	13.5	8	37	65	PA6	-30°C to +100°C
10.4015 PAVSW		M40	14	8	46	65	PA6	-30°C to +100°C
10.5015 PAVSW		M50	16.5	10	56	65	PA6	-30°C to +100°C
10.6315 PAVSW		M63	17	12	70	65	PA6	-30°C to +100°C

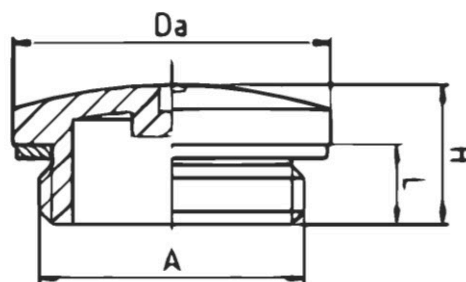

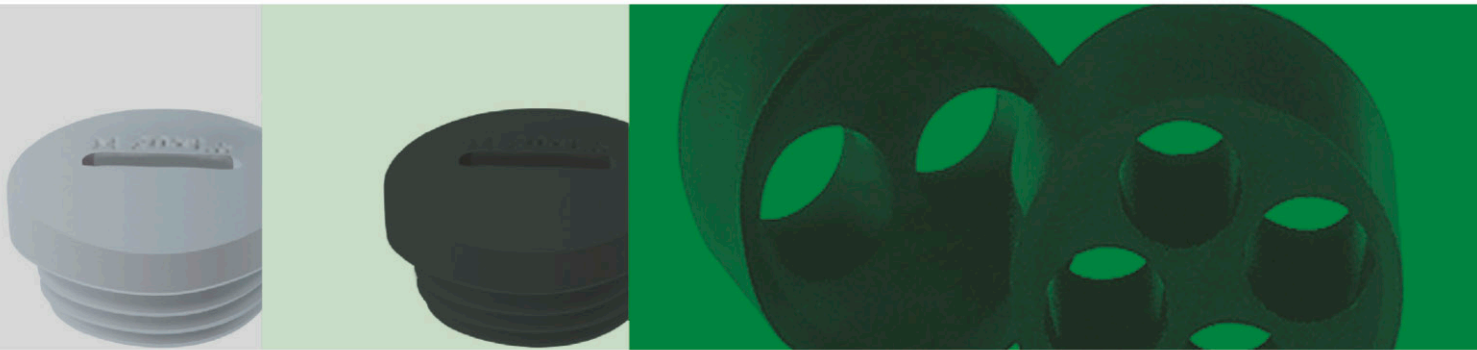

IP54 METRIC NYLON BLANKING PLUG - NO SEALING RING

Part Code	For Use With	Size	H (mm)	n x Di (mm)	ØC (mm)	IP Rating	Material	Temp Rating
10.1215 PA	Grey RAL 7001	M12	10	6	15	54	PA6	-30°C to +100°C
10.1615 PA		M16	10.5	6	20	54	PA6	-30°C to +100°C
10.2015 PA		M20	10.5	6	24	54	PA6	-30°C to +100°C
10.2515 PA		M25	13	8	30	54	PA6	-30°C to +100°C
10.3125 PA		M32	13.5	8	37	54	PA6	-30°C to +100°C
10.4015 PA		M40	14	8	46	54	PA6	-30°C to +100°C
10.5015 PA		M50	16.5	10	56	54	PA6	-30°C to +100°C
10.6315 PA		M63	17	12	70	54	PA6	-30°C to +100°C
10.1215 PA7035	Grey RAL 7035	M12	10	6	15	54	PA6	-30°C to +100°C
10.1615 PA7035		M16	10.5	6	20	54	PA6	-30°C to +100°C
10.2015 PA7035		M20	10.5	6	24	54	PA6	-30°C to +100°C
10.2515 PA7035		M25	13	8	30	54	PA6	-30°C to +100°C
10.3215 PA7035		M32	13.5	8	37	54	PA6	-30°C to +100°C
10.4015 PA7035		M40	14	8	46	54	PA6	-30°C to +100°C
10.5015 PA7035		M50	16.5	10	56	54	PA6	-30°C to +100°C
10.6315 PA7035		M63	17	12	70	54	PA6	-30°C to +100°C
10.1215 PASW	Black RAL 9005	M12	10	6	15	54	PA6	-30°C to +100°C
10.1615 PASW		M16	10.5	6	20	54	PA6	-30°C to +100°C
10.2015 PASW		M20	10.5	6	24	54	PA6	-30°C to +100°C
10.2515 PASW		M25	13	8	30	54	PA6	-30°C to +100°C
10.3125 PASW		M32	13.5	8	37	54	PA6	-30°C to +100°C
10.4015 PASW		M40	14	8	46	54	PA6	-30°C to +100°C
10.5015 PASW		M50	16.5	10	56	54	PA6	-30°C to +100°C
10.6315 PASW		M63	17	12	70	54	PA6	-30°C to +100°C

MULTI-HOLE SEALING INSERTS

WJ-DM 12/3x2.3	Perfect series 50.6xx PAzzzz & Perfect series 50.1xx PAzzzz. Other sizes and hole configurations also available, please request details.	M12	6.6	3x2.3	8.5	N/A	Evoprene TPE	-30°C to +100°C
WJ-DM 16/2x4.5		M16	7.6	2x4.5	11.7	N/A	Evoprene TPE	-30°C to +100°C
WJ-DM 16/4x2.3		M16	7.6	4x2.3	11.7	N/A	Evoprene TPE	-30°C to +100°C
WJ-DM 20/2x4		M20	7.5	2x4	15.1	N/A	Evoprene TPE	-30°C to +100°C
WJ-DM 20/2x6		M20	7.5	2x6	15.1	N/A	Evoprene TPE	-30°C to +100°C
WJ-DM 20/4x5		M20	7.5	4x5	15.1	N/A	Evoprene TPE	-30°C to +100°C
WJ-DM 25/3x6		M25	9.3	3x6	19.8	N/A	Evoprene TPE	-30°C to +100°C
WJ-DM 25/3x7		M25	9.3	3x7	19.8	N/A	Evoprene TPE	-30°C to +100°C
WJ-DM 25/4x5		M25	9.3	4x5	19.8	N/A	Evoprene TPE	-30°C to +100°C
WJ-DM 25/4x6		M25	9.3	4x6	19.8	N/A	Evoprene TPE	-30°C to +100°C
WJ-DM 32/4x7		M32	12.5	4x7	25.1	N/A	Evoprene TPE	-30°C to +100°C
WJ-DM 32/4x8		M32	12.5	4x8	25.1	N/A	Evoprene TPE	-30°C to +100°C
WJ-DM 32/4x8.5		M32	12.5	4x8.5	25.1	N/A	Evoprene TPE	-30°C to +100°C
WJ-DM 40/5x8.5		M40	15	5x8.5	32.3	N/A	Evoprene TPE	-30°C to +100°C
WJ-DM 12 STO		M12	6.6		8.5	N/A	Evoprene TPE	-30°C to +100°C



NYLON PERFECT PG IP68 CABLE GLANDS



Features:

- Pg Nylon Glands.
- Easy to install.
- 50.0xx range offers protection against twisting and also offers integrated anchorage.
- Temperature rating -20°C to +100°C.



IP68 PG PERFECT NYLON CABLE GLAND



Part Code	Colour	Size	H (mm)	L (mm)	ØC (mm)	Material
50.007 PA	Grey RAL 7001	Pg7	30.5	8	3 - 6.5	Polyamide PA6 V-2
50.009 PA		Pg9	34	8	4 - 8	Polyamide PA6 V-2
50.011 PA		Pg11	37	8	5 - 10	Polyamide PA6 V-2
50.013 PA		Pg13.5	39	9	6 - 12	Polyamide PA6 V-2
50.016 PA		Pg16	42.5	10	10 - 14	Polyamide PA6 V-2
50.021 PA		Pg21	47.5	11	13 - 18	Polyamide PA6 V-2
50.029 PA		Pg29	53	11	18 - 25	Polyamide PA6 V-2
50.036 PA		Pg36	61	13	22 - 32	Polyamide PA6 V-2
50.042 PA		Pg42	65	13	30 - 38	Polyamide PA6 V-2
50.048 PA		Pg48	67	14	34 - 44	Polyamide PA6 V-2
50.007 PA7035	Grey RAL 7035	Pg7	30.5	8	3 - 6.5	Polyamide PA6 V-2
50.009 PA7035		Pg9	34	8	4 - 8	Polyamide PA6 V-2
50.011 PA7035		Pg11	37	8	5 - 10	Polyamide PA6 V-2
50.013 PA7035		Pg13.5	39	9	6 - 12	Polyamide PA6 V-2
50.016 PA7035		Pg16	42.5	10	10 - 14	Polyamide PA6 V-2
50.021 PA7035		Pg21	47.5	11	13 - 18	Polyamide PA6 V-2
50.029 PA7035		Pg29	53	11	18 - 25	Polyamide PA6 V-2
50.036 PA7035		Pg36	61	13	22 - 32	Polyamide PA6 V-2
50.042 PA7035		Pg42	65	13	30 - 38	Polyamide PA6 V-2
50.048 PA7035		Pg48	67	14	34 - 44	Polyamide PA6 V-2
50.007 PA/SW	Black RAL 9005	Pg7	30.5	8	3 - 6.5	Polyamide PA6 V-2
50.009 PA/SW		Pg9	34	8	4 - 8	Polyamide PA6 V-2
50.011 PA/SW		Pg11	37	8	5 - 10	Polyamide PA6 V-2
50.013 PA/SW		Pg13.5	39	9	6 - 12	Polyamide PA6 V-2
50.016 PA/SW		Pg16	42.5	10	10 - 14	Polyamide PA6 V-2
50.021 PA/SW		Pg21	47.5	11	13 - 18	Polyamide PA6 V-2
50.029 PA/SW		Pg29	53	11	18 - 25	Polyamide PA6 V-2
50.036 PA/SW		Pg36	61	13	22 - 32	Polyamide PA6 V-2
50.042 PA/SW		Pg42	65	13	30 - 38	Polyamide PA6 V-2
50.048 PA/SW		Pg48	67	14	34 - 44	Polyamide PA6 V-2

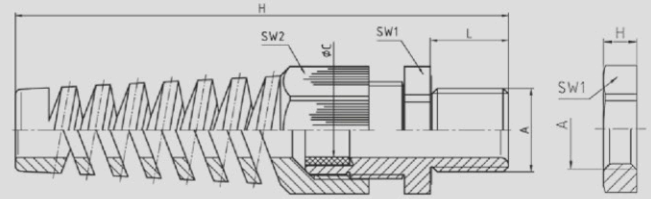
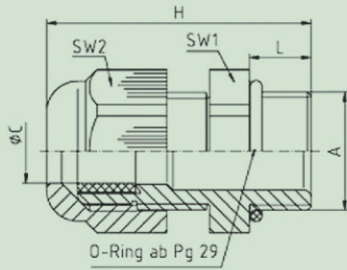

IP68 PERFECT NYLON CABLE GLAND WITH SPIRAL TOP CABLE PROTECTOR



Part Code	Colour	Size	H (mm)	L (mm)	ØC (mm)	Material
50.007 PA/BS	Grey RAL 7001	Pg7	63	8	3 - 6.5	Polyamide PA6 V-2
50.009 PA/BS		Pg9	74	8	4 - 8	Polyamide PA6 V-2
50.011 PA/BS		Pg11	87	8	5 - 10	Polyamide PA6 V-2
50.013 PA/BS		Pg13.5	98	9	6 - 12	Polyamide PA6 V-2
50.016 PA/BS		Pg16	112	10	10 - 14	Polyamide PA6 V-2
50.021 PA/BS		Pg21	130	11	13 - 18	Polyamide PA6 V-2
50.007 PABSSW	Black RAL 9005	Pg7	63	8	3 - 6.5	Polyamide PA6 V-2
50.009 PABSSW		Pg9	74	8	4 - 8	Polyamide PA6 V-2
50.011 PABSSW		Pg11	87	8	5 - 10	Polyamide PA6 V-2
50.013 PABSSW		Pg13.5	98	9	6 - 12	Polyamide PA6 V-2
50.016 PABSSW		Pg16	112	10	10 - 14	Polyamide PA6 V-2
50.021 PABSSW		Pg21	130	11	13 - 18	Polyamide PA6 V-2
50007PABS7035	Grey RAL 7035	Pg7	63	8	3 - 6.5	Polyamide PA6 V-2
50009PABS7035		Pg9	74	8	4 - 8	Polyamide PA6 V-2
50011PABS7035		Pg11	87	8	5 - 10	Polyamide PA6 V-2
50013PABS7035		Pg13.5	98	9	6 - 12	Polyamide PA6 V-2
50016PABS7035		Pg16	112	10	10 - 14	Polyamide PA6 V-2
50021PABS7035		Pg21	130	11	13 - 18	Polyamide PA6 V-2



NYLON PG GLAND ACCESSORIES & LOCKNUTS

ACCESSORIES

LOCKNUTS

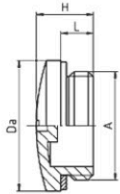
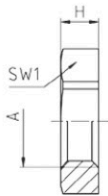

Part Code	Colour	Size	IP Rating	H (mm)	L (mm)	ØC (mm)	Temp Rating	Material
207 PA	Grey RAL 7001	Pg7	N/A	5	N/A	N/A	-20°C to +100°C	PA6 GF30
209 PA		Pg9	N/A	5	N/A	N/A	-20°C to +100°C	PA6 GF30
211 PA		Pg11	N/A	5	N/A	N/A	-20°C to +100°C	PA6 GF30
213 PA		Pg13	N/A	6	N/A	N/A	-20°C to +100°C	PA6 GF30
216 PA		Pg16	N/A	6	N/A	N/A	-20°C to +100°C	PA6 GF30
221 PA		Pg21	N/A	7	N/A	N/A	-20°C to +100°C	PA6 GF30
229 PA		Pg29	N/A	7	N/A	N/A	-20°C to +100°C	PA6 GF30
236 PA		Pg36	N/A	8	N/A	N/A	-20°C to +100°C	PA6 GF30
242 PA		Pg42	N/A	8	N/A	N/A	-20°C to +100°C	PA6 GF30
248 PA		Pg48	N/A	8	N/A	N/A	-20°C to +100°C	PA6 GF30
207 PA7035	Grey RAL 7035	Pg7	N/A	5	N/A	N/A	-20°C to +100°C	PA6 GF30
209 PA7035		Pg9	N/A	5	N/A	N/A	-20°C to +100°C	PA6 GF30
211 PA7035		Pg11	N/A	5	N/A	N/A	-20°C to +100°C	PA6 GF30
213 PA7035		Pg13	N/A	6	N/A	N/A	-20°C to +100°C	PA6 GF30
216 PA7035		Pg16	N/A	6	N/A	N/A	-20°C to +100°C	PA6 GF30
221 PA7035		Pg21	N/A	7	N/A	N/A	-20°C to +100°C	PA6 GF30
229 PA7035		Pg29	N/A	7	N/A	N/A	-20°C to +100°C	PA6 GF30
236 PA7035		Pg36	N/A	8	N/A	N/A	-20°C to +100°C	PA6 GF30
242 PA7035		Pg42	N/A	8	N/A	N/A	-20°C to +100°C	PA6 GF30
248 PA7035		Pg48	N/A	8	N/A	N/A	-20°C to +100°C	PA6 GF30
207 PA/SW	Black RAL 9005	Pg7	N/A	5	N/A	N/A	-20°C to +100°C	PA6 GF30
209 PA/SW		Pg9	N/A	5	N/A	N/A	-20°C to +100°C	PA6 GF30
211 PA/SW		Pg11	N/A	5	N/A	N/A	-20°C to +100°C	PA6 GF30
213 PA/SW		Pg13	N/A	6	N/A	N/A	-20°C to +100°C	PA6 GF30
216 PA/SW		Pg16	N/A	6	N/A	N/A	-20°C to +100°C	PA6 GF30
221 PA/SW		Pg21	N/A	7	N/A	N/A	-20°C to +100°C	PA6 GF30
229 PA/SW		Pg29	N/A	7	N/A	N/A	-20°C to +100°C	PA6 GF30
236 PA/SW		Pg36	N/A	8	N/A	N/A	-20°C to +100°C	PA6 GF30
242 PA/SW		Pg42	N/A	8	N/A	N/A	-20°C to +100°C	PA6 GF30
248 PA/SW		Pg48	N/A	8	N/A	N/A	-20°C to +100°C	PA6 GF30

IP54 SCREW PLUG



Part Code	Colour	Size	IP Rating	H (mm)	L (mm)	Ø (mm)	Temp Rating	Material
1007 PA	Grey RAL 7035	Pg7	54	10	6	15	-30°C to +90°C	PA6
1009 PA		Pg9	54	10	6	19	-30°C to +90°C	PA6
1011 PA		Pg11	54	10	6	22	-30°C to +90°C	PA6
1013 PA		Pg13	54	10	6	25	-30°C to +90°C	PA6
1016 PA		Pg16	54	10	6	27	-30°C to +90°C	PA6
1021 PA		Pg21	54	12.5	8	33	-30°C to +90°C	PA6
1029 PA		Pg29	54	13	8	44.5	-30°C to +90°C	PA6
1036 PA		Pg36	54	15	10	55.5	-30°C to +90°C	PA6
1042 PA		Pg42	54	15.5	10	62.5	-30°C to +90°C	PA6
1048 PA		Pg48	54	17	12	69.5	-30°C to +90°C	PA6

MULTIHOLE SEALING INSERT



Part Code	For Use With	Size	IP Rating	H (mm)	n x Di (mm)	ØC (mm)	Temp Rating	Material
WJ-D 9/3x2	Perfect series 50.0xx PAzzzz & Perfect series 50.1xx PAzzzz. Other sizes and hole configurations also available, please request details.	Pg9	N/A	7.5	3x2	10.6	-30°C to +90°C	Evoprene TPE
WJ-D 9/3x3.5		Pg9	N/A	7.5	3x3.5	10.6	-30°C to +90°C	Evoprene TPE
WJ-D 11/2x5		Pg11	N/A	8.5	2x5	13.3	-30°C to +90°C	Evoprene TPE
WJ-D 11/3x3		Pg11	N/A	8.5	3x3	13.3	-30°C to +90°C	Evoprene TPE
WJ-D 11/3x4		Pg11	N/A	8.5	3x4	13.3	-30°C to +90°C	Evoprene TPE
WJ-D 13/2x5		Pg13.5	N/A	8.5	2x5	15.3	-30°C to +90°C	Evoprene TPE
WJ-D 13/2x6		Pg13.5	N/A	8.5	2x6	15.3	-30°C to +90°C	Evoprene TPE
WJ-D 13/3x4		Pg13.5	N/A	8.5	3x4	15.3	-30°C to +90°C	Evoprene TPE
WJ-D16/3x6		Pg16	N/A	9	3x6	17.4	-30°C to +90°C	Evoprene TPE
WJ-D16/3x6.5		Pg16	N/A	9	3x6.5	17.4	-30°C to +90°C	Evoprene TPE
WJ-D 16/3x7		Pg16	N/A	9	3x7	17.4	-30°C to +90°C	Evoprene TPE
WJ-D 16/4x4		Pg16	N/A	9	4x4	17.4	-30°C to +90°C	Evoprene TPE
WJ-D 21/3x7		Pg21	N/A	11	3x7	22.2	-30°C to +90°C	Evoprene TPE
WJ-D 21/3x8		Pg21	N/A	11	3x8	22.2	-30°C to +90°C	Evoprene TPE
WJ-D 21/4x5		Pg21	N/A	11	4x5	22.2	-30°C to +90°C	Evoprene TPE
WJ-D 21/4x6.5		Pg21	N/A	11	4x6.5	22.2	-30°C to +90°C	Evoprene TPE
WJ-D 29/6x5		Pg29	N/A	13	6x5	29.8	-30°C to +90°C	Evoprene TPE
WJ-D 29/6x7.5		Pg29	N/A	13	6x7.5	29.8	-30°C to +90°C	Evoprene TPE

OTHER STYLES OF GLAND ARE AVAILABLE

KRALLEN CABLE GLAND



Features:

- Protection rating IP65.
- Temp Rating -30°C to +100°C.
- Sizes Range Pg7 to Pg29.
- Material Polyamide PA6 GF30.
- Bend protection versions also available.
- RAL 7035.

CONUS CABLE GLAND



Features:

- Protection rating IP55.
- Temp Rating of -30°C to +80°C.
- Size range of Pg7 to Pg48.
- Material Polyamide PA6 GF30.
- Multiple sealing ring version also available.
- RAL 7035.

UNI DICHT CABLE GLAND



Features:

- Protection rating IP68.
- Temp Rating of -20°C to +100°C.
- Size range Pg9/11 to Pg36.
- Material Polyamide PA6.
- RAL 7035.

FAVORIT CABLE GLAND



Features:

- Protection rating IP55.
- Temp Rating of -30°C to +80°C.
- Size Range Pg9 to Pg29.
- Material Polyamide PA6 GF30.
- RAL 7035.

REDUCERS



Features:

- Material PA6 GF30.
- Temp Rating -30°C to +100°C.
- Size Range Pg9 to Pg48.
- RAL 7035 & RAL 9005.
- Two designs available.

ENLARGERS



Features:

- Material PA6 GF30.
- Temp Rating -30°C to +100°C.
- Size From Pg7 to Pg42.
- RAL 7035.

NICKEL PLATED BRASS PERFECT METRIC CABLE GLANDS

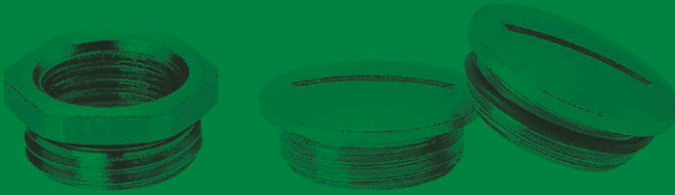

Features:

- Easy to install.
- Up to IP68 protection.
- Made From Nickel Plated Brass.



IP68 PERFECT NICKEL PLATED BRASS CABLE GLAND LONG THREAD



Part Code	Size	H (mm)	L (mm)	ØC (mm)	Temp Rating
50.612M-L	M12	30	10	3 - 6	-20°C to +100°C
50.616M-L	M16	35	10	5 - 9	-20°C to +100°C
50.620M-L	M20	37.5	10	9 - 13	-20°C to +100°C
50.625M-L	M25	40.5	11	11 - 16	-20°C to +100°C
50.632M-L	M32	43	13	14 - 21	-20°C to +100°C
50.640M-L	M40	46	13	19 - 27	-20°C to +100°C
50.650M-L	M50	54.5	14	24 - 35	-20°C to +100°C
50.663M-L	M63	56.5	14	32 - 42	-20°C to +100°C
50.663 M1-L	M63	56.5	14	38 - 48	-20°C to +100°C

IP68 PERFECT NICKEL PLATED BRASS WITH REDUCING INSERT



50.612 M/R	M12	25	5	2 - 5	-20°C to +100°C
50.616 M/R	M16	30	5	3 - 9	-20°C to +100°C
50.620 M/R	M20	33.5	6	5 - 13	-20°C to +100°C
50.625 M/R	M25	36.5	7	8 - 16	-20°C to +100°C
50.632 M/R	M32	38	8	12 - 21	-20°C to +100°C
50.640 M/R	M40	41	8	16 - 27	-20°C to +100°C
50.650 M/R	M50	49.5	9	21 - 35	-20°C to +100°C
50.663 M/R	M63	52.5	10	27 - 48	-20°C to +100°C

IP66 PERFECT NICKEL PLATED BRASS CABLE GLAND FOR FLAT PROFILE CABLE



50.620 MFK1	M20	33.5	6	5x12 max, 2x9 min	-20°C to +100°C
50.625 MFK1	M25	36.5	7	6x16.3 max, 2x11 min	-20°C to +100°C
50.632 MFK1	M32	38	8	9x20 max, 3x13 min	-20°C to +100°C
50.640 MFK1	M40	41	8	10x27 max, 3x17 min	-20°C to +100°C
50.650 MFK1	M50	49.5	9	13x34 max, 4x24 min	-20°C to +100°C
50.663 MFK1	M63	52.5	10	15x45 max, 5x33 min	-20°C to +100°C

IP65 PERFECT NICKEL PLATED BRASS CABLE GLAND FOR ASI PROFILE CABLE



50.620 M/ASI/1	M20	33.5	6	1x ASI cable	-20°C to +100°C
50.625 M/ASI/1	M25	36.5	7	1x ASI cable	-20°C to +100°C
50.620 M/ASI/2	M20	33.5	6	2x ASI cable	-20°C to +100°C
50.625 M/ASI/2	M25	36.5	7	2x ASI cable	-20°C to +100°C

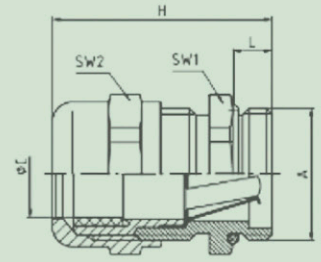
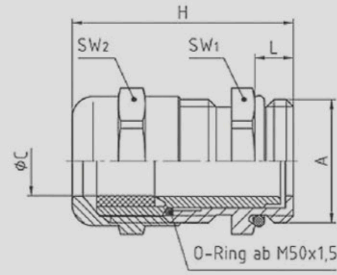

IP68 LONG THREAD IN-LINE EMC SHIELD VERSION



Part Code	Size	H (mm)	L (mm)	ØC (mm)	Temp Rating
50.616 M/EMVDL	M16	35	10	5 - 9	-20°C to +100°C
50.620 M/EMVDL	M20	37.5	10	9 - 13	-20°C to +100°C
50.625 M/EMVDL	M25	40.5	11	11 - 16	-20°C to +100°C
50.632 M/EMVDL	M32	43	13	14 - 21	-20°C to +100°C
50.640 M/EMVDL	M40	46	13	19 - 27	-20°C to +100°C

IP68 EMC SHIELD VERSION LONG THREAD



50.612 M/EMV/L	M12	30	10	3 - 6	-20°C to +100°C
50.616 M/EMV/L	M16	35	10	5 - 9	-20°C to +100°C
50.620 M/EMV/L	M20	37.5	10	9 - 13	-20°C to +100°C
50.625 M/EMV/L	M25	40.5	11	11 - 16	-20°C to +100°C
50.632 M/EMV/L	M32	43	13	14 - 21	-20°C to +100°C
50.640 M/EMV/L	M40	46	13	19 - 27	-20°C to +100°C
50.650 M/EMV/L	M50	54.5	14	24 - 35	-20°C to +100°C
50.663 M/EMV/L	M63	56.5	14	32 - 42	-20°C to +100°C
50.663 M1/EMV/L	M63	56.5	14	38 - 48	-20°C to +100°C



IP65 WADI SPECIAL SMALL CABLE HIGH TEMPERATURE GLAND

111005	M6	16.5	6	2 - 3.2	-30°C to +100°C
111006	M8	19	6	3 - 5	-30°C to +100°C
111010	M10	19.5	6	4 - 6	-30°C to +100°C
111072	M72	59.5	18	53 - 60	-30°C to +100°C

EMVD STYLE EMC GLAND

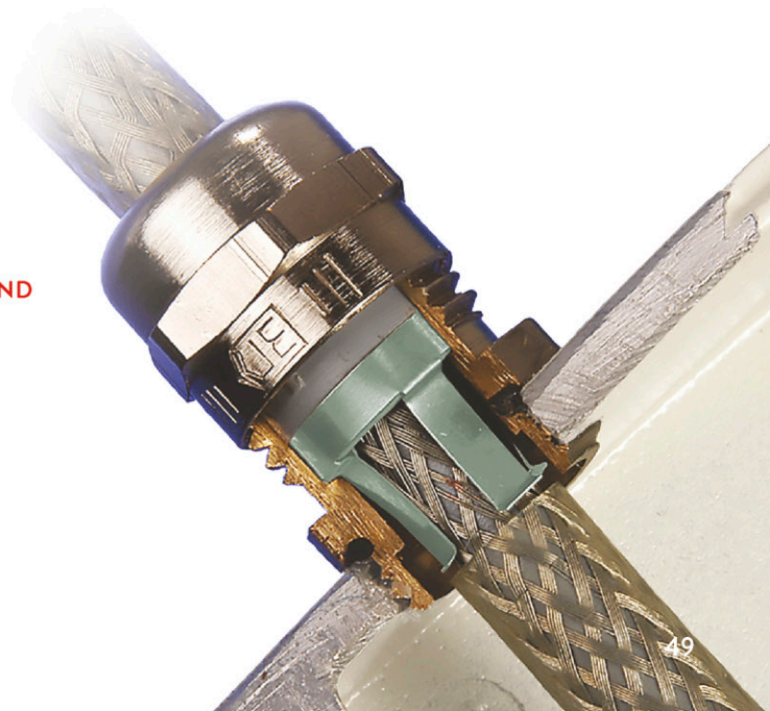

NICKEL PLATED BRASS METRIC IP68 ATEX GLANDS



Brass Explosion Proof Cable Glands:

- Brass CuZn39Pb3, nickel-plated.
- IP68 to 5 Bar.
- Temperature Rating of -20°C to +80°C.
- Equipment group: II.
- Category/Zone: 2G and 2D/1, 2, 21, 22.



Vibration Damage Reducing:

- Brass CuZn39Pb3, nickel-plated.
- IP68.
- Temperature Rating of -20°C to +80°C.
- EMC Versions Available.



IP68 BRASS EXPLOSION PROOF CABLE GLANDS

IP68 PERFECT NICKEL PLATED BRASS EXPLOSION PROOF CABLE GLANDS



Product Code	Size	H (mm)	L (mm)	ØC (mm)
50.612 M/L/EX	M12	30	10	3 - 6
50.616 M/L/EX	M16	34	10	5 - 9
50.620 M/L/EX	M20	37	10	9 - 13
50.625 M/L/EX	M25	40.5	11	11 - 16
50.632 M/L/EX	M32	43	13	14 - 21
50.640 M/L/EX	M40	46	13	19 - 27
50.650 M/L/EX	M50	52.5	14	24 - 35
50.663 M/L/EX	M63	58.5	14	32 - 42
50.663 M1/L/EX	M63	58.5	14	38 - 48

IP68 PERFECT EMC NICKEL PLATED BRASS EXPLOSION PROOF CABLE GLANDS



50.612 M/EMVLEX	M12	30	10	3 - 6
50.616 M/EMVLEX	M16	34	10	5 - 9
50.620 M/EMVLEX	M20	37	10	9 - 13
50.625 M/EMVLEX	M25	40.5	11	11 - 16
50.632 M/EMVLEX	M32	43	13	14 - 21
50.640 M/EMVLEX	M40	46	13	19 - 27
50.650 M/EMVLEX	M50	52.5	14	24 - 35
50.663 M/EMVLEX	M63	58.5	14	32 - 42
50.663 M1/EMVLEX	M63	58.5	14	38 - 48

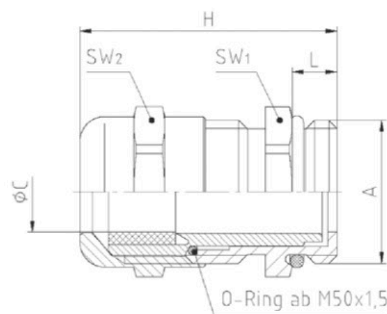

NICKEL PLATED BRASS METRIC IP68 ACCESSORIES & LOCKNUTS



Accessories Features:

- Brass CuZn39Pb3, nickel-plated.
- IP68.
- Temperature Rating of -20°C to +80°C.

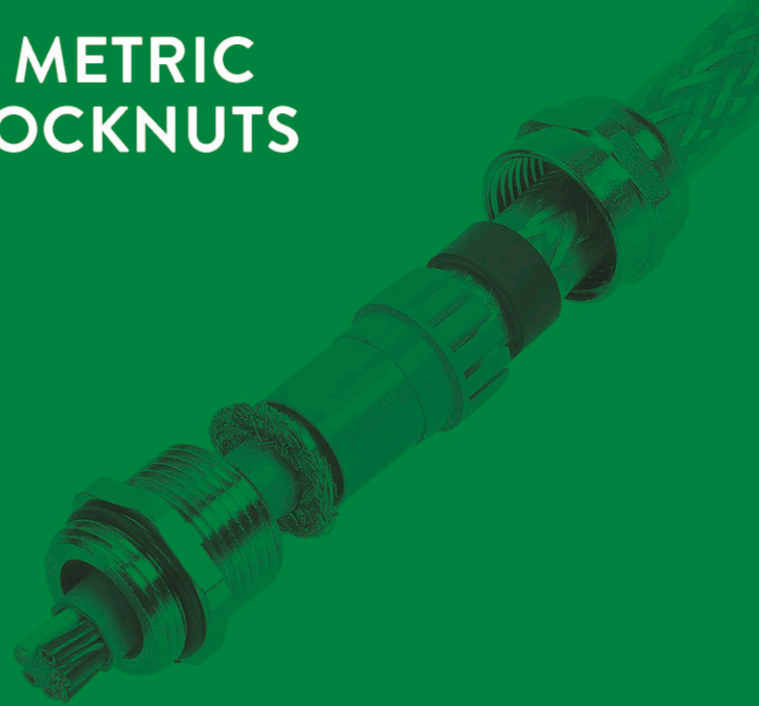

ACCESSORIES

IP68 PERFECT NICKEL PLATED BRASS EXPLOSION PROOF SCREW PLUG



Product Code	Size	H (mm)	L (mm)
10.1215 M/G/EX	M12	8	5
10.1615 M/G/EX	M16	9	6
10.2015 M/G/EX	M20	9.5	6.5
10.2515 M/G/EX	M25	11	7
10.3215 M/G/EX	M32	12	8
10.4015 M/G/EX	M40	12	8
10.5015 M/G/EX	M50	15	9
10.6315 M/G/EX	M63	16	10

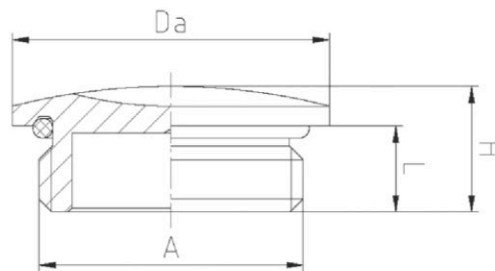

NICKEL PLATED BRASS METRIC IP68 ACCESSORIES & LOCKNUTS

ACCESSORIES

METRIC LOCKNUTS



Part Code	IP Rating	Colour	Material	Size	H (mm)	L (mm)	ØC (mm)	Temp Rating
50.212 M	N/A	Silver	Nickel Plated Brass	M12	2.8	N/A	N/A	-60°C to +200°C
50.216 M	N/A	Silver		M16	2.8	N/A	N/A	-60°C to +200°C
50.220 M	N/A	Silver		M20	3	N/A	N/A	-60°C to +200°C
50.225 M	N/A	Silver		M25	3.5	N/A	N/A	-60°C to +200°C
50.232 M	N/A	Silver		M32	4	N/A	N/A	-60°C to +200°C
50.240 M	N/A	Silver		M40	5	N/A	N/A	-60°C to +200°C
50.250 M	N/A	Silver		M50	5	N/A	N/A	-60°C to +200°C
50.263 M	N/A	Silver		M63	6	N/A	N/A	-60°C to +200°C

IP68 SCREW PLUG WITH O RING AND SLOT TOP



10.1210 M/G	68	Silver	Nickel Plated Brass	M12	7.5	4.5	16	-30°C to +100°C
10.1215 M/G	68	Silver		M12	8	5	16	-30°C to +100°C
10.1615 M/G	68	Silver		M16	9	6	20	-30°C to +100°C
10.2015 M/G	68	Silver		M20	9.5	6.5	24	-30°C to +100°C
10.2515 M/G	68	Silver		M25	11	7	28	-30°C to +100°C
10.3215 M/G	68	Silver		M32	12	8	35	-30°C to +100°C
10.4015 M/G	68	Silver		M40	12	8	45	-30°C to +100°C
10.5015 M/G	68	Silver		M50	15	9	55	-30°C to +100°C
10.6315 M/G	68	Silver		M63	16	10	68	-30°C to +100°C

IP54 SCREW PLUG WITH SLOT TOP



10.1210	54	Silver	Nickel Plated Brass	M12	7.5	4.5	16	-60°C to +200°C
10.1215	54	Silver		M12	8	5	16	-60°C to +200°C
10.1615	54	Silver		M16	9	6	20	-60°C to +200°C
10.2015	54	Silver		M20	9.5	6.5	24	-60°C to +200°C
10.2515	54	Silver		M25	11	7	28	-60°C to +200°C
10.3215	54	Silver		M32	12	8	35	-60°C to +200°C
10.4015	54	Silver		M40	12	8	45	-60°C to +200°C
10.5015	54	Silver		M50	15	9	55	-60°C to +200°C
10.6315	54	Silver		M63	16	10	68	-60°C to +200°C

OTHER STYLES OF GLAND ARE AVAILABLE

KOMPAKT GLANDS:



Features:

- IP55 rated.
- Available in Standard or with rubber bushing inside.
- Temperature rating of -30°C to +100°C.
- Sizes From M12 - M63.

NPB GLAND WITH CLAMPING JAW:



Features:

- IP55 rated.
- Temperature rating of -30°C to +100°C.
- Sizes From M12 - M63.



ENLARGER ADAPTER METRIC/METRIC



Part Code	IP Rating	Colour	Material	Size	H (mm)	L (mm)	ØC (mm)	Temp Rating
M12M16/FR	N/A	Silver	Nickel Plated Brass	M12/M16	16	5	8	Bis +200°C
M16M20/FR	N/A	Silver		M16/M20	16.5	5	12	Bis +200°C
M20M25/FR	N/A	Silver		M20/M25	18.5	6	15	Bis +200°C
M25M32/FR	N/A	Silver		M25/M32	20.5	7	21	Bis +200°C
M32M40/FR	N/A	Silver		M32/M40	23.5	8	26	Bis +200°C
M40M50/FR	N/A	Silver		M40/M50	30	8	34	Bis +200°C
M50M63/FR	N/A	Silver		M50/M63	32.5	9	44	Bis +200°C

EMC CUTTING LOCKNUTS



50.212 MPOT	N/A	Silver	Nickel Plated Brass	M12	5.5	4.5	N/A	-60°C to +200°C
50.216 MPOT	N/A	Silver		M16	5.5	4.5	N/A	-60°C to +200°C
50.220 MPOT	N/A	Silver		M20	5.5	4.5	N/A	-60°C to +200°C
50.225 MPOT	N/A	Silver		M25	5.5	4.5	N/A	-60°C to +200°C
50.232 MPOT	N/A	Silver		M32	5.5	4.5	N/A	-60°C to +200°C
50.240 MPOT	N/A	Silver		M40	6	5	N/A	-60°C to +200°C
50.250 MPOT	N/A	Silver		M50	6	5	N/A	-60°C to +200°C
50.263 MPOT	N/A	Silver		M63	7	6	N/A	-60°C to +200°C

MULTI-HOLE SEALING INSERT



Part Code	Suitable for product types	Gland Thread	H (mm)	Multi-hole	Ø (mm)	Temp Rating	Material
WJ-DM 12/3x2.3	Perfect series 50.6xx M & Perfect series 50.1xx M. Other sizes and hole configurations also available - please request details.	M12	6.6	3x2.3	8.5	-30°C to +100°C	Evoprene TPE
WJ-DM 16/2x4.5		M16	7.6	2x4.5	11.7	-30°C to +100°C	Evoprene TPE
WJ-DM 16/4x2.3		M16	7.6	4x2.3	11.7	-30°C to +100°C	Evoprene TPE
WJ-DM 20/2x4		M20	7.5	2x4	15.1	-30°C to +100°C	Evoprene TPE
WJ-DM 20/2x6		M20	7.5	2x6	15.1	-30°C to +100°C	Evoprene TPE
WJ-DM 20/4x5		M20	7.5	4x5	15.1	-30°C to +100°C	Evoprene TPE
WJ-DM 25/3x6		M25	9.3	3x6	19.8	-30°C to +100°C	Evoprene TPE
WJ-DM 25/3x7		M25	9.3	3x7	19.8	-30°C to +100°C	Evoprene TPE
WJ-DM 25/4x5		M25	9.3	4x5	19.8	-30°C to +100°C	Evoprene TPE
WJ-DM 25/4x6		M25	9.3	4x6	19.8	-30°C to +100°C	Evoprene TPE
WJ-DM 32/4x7	M32	12.5	4x7	25.1	-30°C to +100°C	Evoprene TPE	
WJ-DM 32/4x8	M32	12.5	4x8	25.1	-30°C to +100°C	Evoprene TPE	

NPB GLAND WITH CLAMPING JAW:



Features:

- IP55 rated.
- Available in Standard or with rubber bushing inside.
- Pressure Screw also available.
- Sizes From M12 - M40.

FLAT PROFILE CABLE GLAND:



Features:

- IP55 rated.
- Temperature rating of -30°C to +100°C.
- Sizes From M12 - M63.

NICKEL PLATED BRASS PERFECT IP68 PG CABLE GLANDS



Features:

- Wide sealing and clamping range.
- Pg thread as Per DIN 40430.
- Operating Temp. -20°C - +100°C.
- IP68 Protection.
- Test Standard UL514B.

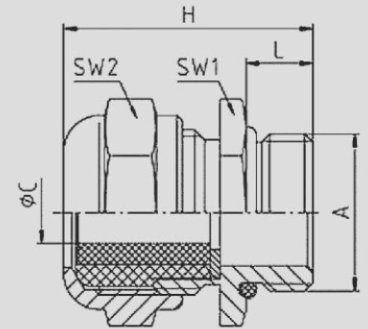

IP68 PERFECT NICKEL PLATED BRASS CABLE GLAND



Part Code	IP Rating	Size	H (mm)	L (mm)	ØC (mm)	Temp Rating
50.007	68	Pg7	24	5	3 - 6.5	-20°C to +100°C
50.009	68	Pg9	29	6	4 - 8	-20°C to +100°C
50.011	68	Pg11	29.5	6	5 - 10	-20°C to +100°C
50.013	68	Pg13.5	31.5	6.5	6 - 12	-20°C to +100°C
50.016	68	Pg16	31.5	6.5	10 - 14	-20°C to +100°C
50.021	68	Pg21	34	7	13 - 18	-20°C to +100°C
50.029	68	Pg29	39	8	18 - 25	-20°C to +100°C
50.036	68	Pg36	45	9	24 - 32	-20°C to +100°C
50.042	68	Pg42	49	10	30 - 38	-20°C to +100°C
50.048	68	Pg48	52	10	34 - 44	-20°C to +100°C

IP68 PERFECT NICKEL PLATED REDUCING BRASS CABLE GLAND



50.007 R	68	Pg7	24	5	2 - 5	-20°C to +100°C
50.009 R	68	Pg9	29	6	2 - 6	-20°C to +100°C
50.011 R	68	Pg11	29.5	6	3 - 7	-20°C to +100°C
50.013 R	68	Pg13.5	31.5	6.5	5 - 9	-20°C to +100°C
50.016 R	68	Pg16	31.5	6.5	7 - 12	-20°C to +100°C
50.021 R	68	Pg21	34	7	9 - 16	-20°C to +100°C
50.029 R	68	Pg29	39	8	12 - 20	-20°C to +100°C
50.036 R	68	Pg36	45	9	20 - 26	-20°C to +100°C

IP68 PERFECT NICKEL PLATED BRASS EMC CABLE GLAND



50.007/EMV	68	Pg7	24	5	3 - 6.5	-20°C to +100°C
50.009/EMV	68	Pg9	29	6	4 - 8	-20°C to +100°C
50.011/EMC	68	Pg11	29.5	6	5 - 10	-20°C to +100°C
50.013/EMV	68	Pg13.5	31.5	6.5	6 - 12	-20°C to +100°C
50.016/EMV	68	Pg16	31.5	6.5	10 - 14	-20°C to +100°C
50.021/EMV	68	Pg21	34	7	13 - 18	-20°C to +100°C
50.029/EMV	68	Pg29	39	8	18 - 25	-20°C to +100°C
50.036/EMV	68	Pg36	45	9	24 - 32	-20°C to +100°C
50.042/EMV	68	Pg42	49	10	30 - 38	-20°C to +100°C
50.048/EMV	68	Pg48	52	10	34 - 44	-20°C to +100°C



ACCESSORIES

Features:

- MPOT locknuts allow for equipotential bonding.
- Locknuts are Nickel plated brass.
- Locknuts have a temperature rating of -60°C to 200°C.
- Sealing rings are constructed from Evoprene TPE.

BRASS HEXAGONAL LOCKNUTS

Part Code	IP Rating	Size	H (mm)	L (mm)	ØC (mm)	Temp Rating
207 M	N/A	Pg7	2.8	N/A	N/A	-60°C to +200°C
209 M	N/A	Pg9	2.8	N/A	N/A	-60°C to +200°C
211 M	N/A	Pg11	3	N/A	N/A	-60°C to +200°C
213 M	N/A	Pg13.5	3	N/A	N/A	-60°C to +200°C
216 M	N/A	Pg16	3	N/A	N/A	-60°C to +200°C
221 M	N/A	Pg21	3.5	N/A	N/A	-60°C to +200°C
229 M	N/A	Pg29	4	N/A	N/A	-60°C to +200°C
236 M	N/A	Pg36	5	N/A	N/A	-60°C to +200°C
242 M	N/A	Pg42	5	N/A	N/A	-60°C to +200°C
248 M	N/A	Pg48	5.5	N/A	N/A	-60°C to +200°C



HEXAGONAL LOCKNUTS EMC

207 MPOT	N/A	Pg7	4.7	3.7	N/A	-60°C to +200°C
209 MPOT	N/A	Pg9	4.7	3.7	N/A	-60°C to +200°C
211 MPOT	N/A	Pg11	4.7	3.7	N/A	-60°C to +200°C
213 MPOT	N/A	Pg13.5	4.7	3.7	N/A	-60°C to +200°C
216 MPOT	N/A	Pg16	4.7	3.7	N/A	-60°C to +200°C
221 MPOT	N/A	Pg21	5.2	4.2	N/A	-60°C to +200°C
229 MPOT	N/A	Pg29	5.7	4.7	N/A	-60°C to +200°C
236 MPOT	N/A	Pg36	6	5	N/A	-60°C to +200°C
242 MPOT	N/A	Pg42	6	5	N/A	-60°C to +200°C
248 MPOT	N/A	Pg48	6.5	5.5	N/A	-60°C to +200°C



ACCESSORIES

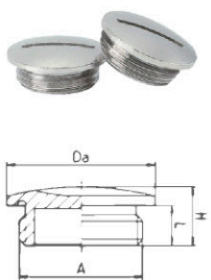

IP54 SCREW PLUG TOP WITH SLOT TOP SILVER NICKEL PLATED BRASS

1007 M	54	Pg7	6	5	14	-60°C to +200°C
1009 M	54	Pg9	9	6	17	-60°C to +200°C
1011 M	54	Pg11	9	6	20	-60°C to +200°C
1013 M	54	Pg13	9.5	6.5	22	-60°C to +200°C
1016 M	54	Pg16	9.5	6.5	24	-60°C to +200°C
1021 M	54	Pg21	11	7	30	-60°C to +200°C
1029 M	54	Pg29	12	8	39	-60°C to +200°C
1036 M	54	Pg36	15	9	50	-60°C to +200°C
1042 M	54	Pg42	16	10	57	-60°C to +200°C
1048 M	54	Pg48	16	10	64	-60°C to +200°C

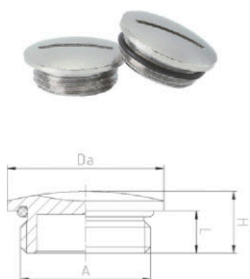

IP68 SCREW PLUG WITH O RING AND SLOT TOP

1007 M/G	68	Pg7	7	4.5	16	-30°C to +100°C
1009 M/G	68	Pg9	8	4.5	19	-30°C to +100°C
1011 M/G	68	Pg11	8	4.5	22	-30°C to +100°C
1013 M/G	68	Pg13	10	6	24	-30°C to +100°C
1016 M/G	68	Pg16	10	6	26	-30°C to +100°C
1021 M/G	68	Pg21	10	6.5	32	-30°C to +100°C
1029 M/G	68	Pg29	12	8	39	-30°C to +100°C
1036 M/G	68	Pg36	15	9	50	-30°C to +100°C
1042 M/G	68	Pg42	16	10	57	-30°C to +100°C
1048 M/G	68	Pg48	16	10	64	-30°C to +100°C

NICKEL PLATED BRASS PG IP68 ACCESSORIES & LOCKNUTS

IP68 REDUCING ADAPTOR WITH O RING SEAL AND HEX COLLAR

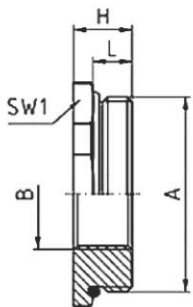

Part Code	IP Rating	Size	H (mm)	L (mm)	ØC (mm)	Temp Rating
60907/OM	68	Pg9 Pg7	8.5	6	N/A	-30°C to +100°C
61107/OM	68	Pg11 Pg7	8.5	6	N/A	-30°C to +100°C
61109/OM	68	Pg11 Pg9	8.5	6	N/A	-30°C to +100°C
61307/OM	68	Pg13 Pg7	9.5	6.5	N/A	-30°C to +100°C
61309/OM	68	Pg13 Pg9	9.5	6.5	N/A	-30°C to +100°C
61311/OM	68	Pg13 Pg11	9.5	6.5	N/A	-30°C to +100°C
61607/OM	68	Pg16 Pg7	9.5	6.5	N/A	-30°C to +100°C
61609/OM	68	Pg16 Pg9	9.5	6.5	N/A	-30°C to +100°C
61611/OM	68	Pg16 Pg11	9.5	6.5	N/A	-30°C to +100°C
61613/OM	68	Pg16 Pg13	9.5	6.5	N/A	-30°C to +100°C
62111/OM	68	Pg21 Pg11	10	7	N/A	-30°C to +100°C
62113/OM	68	Pg21 Pg13	10	7	N/A	-30°C to +100°C
62116/OM	68	Pg21 Pg16	10	7	N/A	-30°C to +100°C
62916/OM	68	Pg29 Pg16	11.5	8	N/A	-30°C to +100°C
62921/OM	68	Pg29 Pg21	11.5	8	N/A	-30°C to +100°C
63621/OM	68	Pg36 Pg21	12.5	9	N/A	-30°C to +100°C
63629/OM	68	Pg36 Pg29	12.5	9	N/A	-30°C to +100°C
64236/OM	68	Pg42 Pg36	14	10	N/A	-30°C to +100°C

OTHER STYLES OF GLAND ARE AVAILABLE

GLAND WITH CLAMPING JAW



Features:

- IP55.
- Material Pg Nickel Plated Brass.
- Temp Rating of -30°C to +100°C.
- Sizes Ranges Pg7 to Pg48.

FAVORIT CABLE GLANDS



Features:

- IP55.
- Pg Nickel Plated Brass.
- Temp Rating of -30°C to +100°C.
- Sizes Range Pg9 to Pg29.
- Also available with rubber bushing.

KOMPAKT PRESSURE SCREW



Features:

- Pg Nickel plated Brass.
- Temp Rating of -60°C +200°C.
- Sizes Range Pg9 to Pg29.

KOMPAKT CABLE GLANDS



Features:

- IP55.
- Pg Nickel Plated Brass.
- Temp Rating of -30°C to +100°C.
- Sizes Range Pg9 to Pg48.
- Also available with rubber bushing.

MULTIHOLE SEALING INSERT

Part Code	For Use With	Size	IP Rating	H (mm)	n x Di (mm)	ØC (mm)	Temp Rating	Material
WJ-D 9/3x2	Perfect series 50.0xx & Perfect series 50.1xx Other sizes and hole configurations also available - please request details.	Pg9	N/A	7.5	3x2	10.6	-30°C to +100°C	Evoprene TPE
WJ-D 9/3x3.5		Pg9	N/A	7.5	3x3.5	10.6	-30°C to +100°C	Evoprene TPE
WJ-D 11/2x5		Pg11	N/A	8.5	2x5	13.3	-30°C to +100°C	Evoprene TPE
WJ-D 11/3x3		Pg11	N/A	8.5	3x3	13.3	-30°C to +100°C	Evoprene TPE
WJ-D 11/3x4		Pg11	N/A	8.5	3x4	13.3	-30°C to +100°C	Evoprene TPE
WJ-D 13/2x5		Pg13.5	N/A	8.5	2x5	15.3	-30°C to +100°C	Evoprene TPE
WJ-D 13/2x6		Pg13.5	N/A	8.5	2x6	15.3	-30°C to +100°C	Evoprene TPE
WJ-D 13/3x4		Pg13.5	N/A	8.5	3x4	15.3	-30°C to +100°C	Evoprene TPE
WJ-D16/3x6		Pg16	N/A	9	3x6	17.4	-30°C to +100°C	Evoprene TPE
WJ-D16/3x6.5		Pg16	N/A	9	3x6.5	17.4	-30°C to +100°C	Evoprene TPE
WJ-D 16/3x7		Pg16	N/A	9	3x7	17.4	-30°C to +100°C	Evoprene TPE
WJ-D 16/4x4		Pg16	N/A	9	4x4	17.4	-30°C to +100°C	Evoprene TPE
WJ-D 21/3x7		Pg21	N/A	11	3x7	22.2	-30°C to +100°C	Evoprene TPE
WJ-D 21/3x8		Pg21	N/A	11	3x8	22.2	-30°C to +100°C	Evoprene TPE
WJ-D 21/4x5		Pg21	N/A	11	4x5	22.2	-30°C to +100°C	Evoprene TPE
WJ-D 21/4x6.5		Pg21	N/A	11	4x6.5	22.2	-30°C to +100°C	Evoprene TPE
WJ-D 29/6x5	Pg29	N/A	13	6x5	29.8	-30°C to +100°C	Evoprene TPE	
WJ-D 29/6x7.5	Pg29	N/A	13	6x7.5	29.8	-30°C to +100°C	Evoprene TPE	



FAVORIT PRESSURE SCREW



Features:

- Pg Nickel plated Brass.
- Temp Rating of -60°C to +200°C.
- Sizes Range Pg9 to Pg29.

CABLE GLANDS FOR FLAT CABLES



Features:

- IP55.
- Pg Nickel Plated Brass.
- Sizes M25-M63.
- Temp Rating of -30°C to +80°C.
- Sizes Range Pg16 to Pg48.

CABLE GLAND WITH BEND PROTECTION



Features:

- IP65.
- Pg Nickel plated Brass.
- Temp Rating of -30°C to +100°C.
- Sizes Range Pg9 to Pg29.

MULTIPLE & SIMPLE SEALING RINGS



Features:

- IP55.
- Pg nickel plated Brass.
- Temp rating of -30°C to +100°C.
- Size Range Pg9 to Pg48.

STAINLESS STEEL PERFECT METRIC IP68 CABLE GLANDS & LOCKNUTS

Features:

- Stainless Steel.
- Wide sealing & clamping ranges.
- Integrated anchorage.
- Easy to install.
- Protection against twisting.

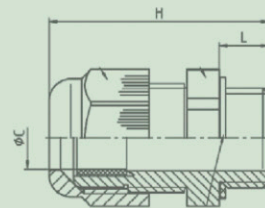

IP68 PERFECT STAINLESS STEEL CABLE GLAND



Part Code	Size	H (mm)	L (mm)	ØC (mm)	Temp Rating
50.612 ES	M12	25	5	3 - 6	-20°C to +100°C
50.616 ES	M16	30	5	5 - 9	-20°C to +100°C
50.620 ES	M20	33.5	6	9 - 13	-20°C to +100°C
50.625 ES	M25	36.5	7	11 - 16	-20°C to +100°C
50.632 ES	M32	38	8	14 - 21	-20°C to +100°C
50.640 ES	M40	41	8	19 - 27	-20°C to +100°C
50.650 ES	M50	49.5	9	24 - 35	-20°C to +100°C
50.663 ES	M63	52.5	10	32 - 42	-20°C to +100°C



IP68 PERFECT EMC GLAND STAINLESS STEEL

50.616 ES/EMV	M16	30	5	5 - 9	-20°C to +100°C
50.620 ES/EMV	M20	33.5	6	9 - 13	-20°C to +100°C
50.625 ES/EMV	M25	36.5	7	11 - 16	-20°C to +100°C
50.632 ES/EMV	M32	38	8	14 - 21	-20°C to +100°C



IP65 WADI EMC CABLE GLAND NBR SEALING INSERT

101011M16ES	M16	25	6	7 - 11.5	-30°C to +100°C
101016M20ES	M20	26	6	8 - 15	-30°C to +100°C
101021M25ES	M25	31	7.5	13 - 20	-30°C to +100°C
101029M32ES	M32	32	8	18 - 25.5	-30°C to +100°C



STAINLESS STEEL LOCKNUT

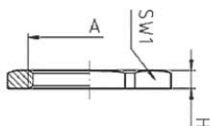

Part Code	Size	H (mm)	SW1 (mm)	A (mm)	Temp Rating
50.212 ES	M12	2.8	14	M12x1.5	Up to +200°C
50.216 ES	M16	2.8	19	M16x1.5	Up to +200°C
50.220 ES	M20	3	24	M20x1.5	Up to +200°C
50.225 ES	M25	3.5	30	M25x1.5	Up to +200°C
50.232 ES	M32	4	36	M32x1.5	Up to +200°C
50.240 ES	M40	5	46	M40x1.5	Up to +200°C
50.250 ES	M50	5	60	M50x1.5	Up to +200°C
50.263 ES	M63	6	70	M63x1.5	Up to +200°C

STAINLESS STEEL PG CABLE GLANDS & LOCKNUTS

Features:

- Stainless Steel.
- Suitable For high temperature applications.
- Easy to install with a wide sealing range.

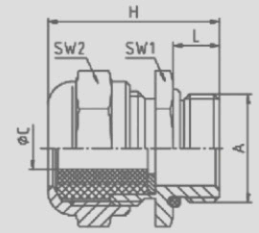

IP65 WADI EMC WITH VITON SEALING INSERT



Part Code	Size	H (mm)	L (mm)	ØC (mm)	Temp Rating
129007	Pg7	22	6	4 - 7	-18°C to +200°C
129009	Pg9	23.5	6.5	5 - 10	-18°C to +200°C
129011	Pg11	24	6	7 - 12	-18°C to +200°C
129013	Pg13,5	27	6	7 - 15	-18°C to +200°C
129016	Pg16	27	6	7 - 15	-18°C to +200°C
129021	Pg21	30.5	7.5	9 - 20	-18°C to +200°C

PG STAINLESS STEEL LOCKNUTS

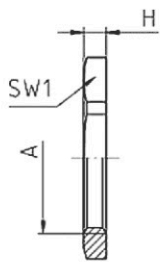

Part Code	Size	H (mm)	SW1 (mm)	ØC (mm)	Temp Rating
129207	Pg7	3	14	N/A	-60°C to +200°C
129209	Pg9	3	19	N/A	-60°C to +200°C
129211	Pg11	3	22	N/A	-60°C to +200°C
129213	Pg13,5	3	24	N/A	-60°C to +200°C
129216	Pg16	3	27	N/A	-60°C to +200°C
129221	Pg21	3.5	32	N/A	-60°C to +200°C
129229	Pg29	4	41	N/A	-60°C to +200°C
129236	Pg36	5	50	N/A	-60°C to +200°C

NYLON METRIC & PG IP68 TEE GLANDS

Features:

- One piece Bi-material moulded gland body.
- Incorporates cable sealing ring and sealing washer in one unit - No additional gaskets required.
- Saves time on assembly.
- Suitable for applications in all major industry sections.
- Moulded sealing material - Grey TPE-V std. Other colours available to order on request.



METRIC TEEGLANDS

Product Code	IP Rating	Colour	Material	H (mm)	Size	Thread Length (mm)	Cable Diameter (mm)
THA.450.A0A	68	Black	Nylon 66	35	M16	8	4 to 7.5
THA.450.A0E	68	Grey	Nylon 66	35	M16	8	4 to 7.5
THA.450.B0A	68	Black	Nylon 66	35	M16	8	7.5 to 9.5
THA.450.B0E	68	Grey	Nylon 66	35	M16	8	7.5 to 9.5
THA.451.A0A	68	Black	Nylon 66	38	M20	8	2x6mm max
THA.451.A0E	68	Grey	Nylon 66	38	M20	8	2x6mm max
THA.451.B0A	68	Black	Nylon 66	38	M20	8	7 to 10.5
THA.451.B0E	68	Grey	Nylon 66	38	M20	8	7 to 10.5
THA.451.B0A	68	Black	Nylon 66	38	M20	8	10.5 to 14
THA.451.B0E	68	Grey	Nylon 66	38	M20	8	10.5 to 14
THA.452.A1A	68	Black	Nylon 66	38	M25	8	2x6mm max
THA.452.A1E	68	Grey	Nylon 66	38	M25	8	2x6mm max
THA.452.B1A	68	Black	Nylon 66	38	M25	8	7 to 10.5
THA.452.B1E	68	Grey	Nylon 66	38	M25	8	7 to 10.5
THA.452.B1A	68	Black	Nylon 66	38	M25	8	10.5 to 14
THA.452.B1E	68	Grey	Nylon 66	38	M25	8	10.5 to 14



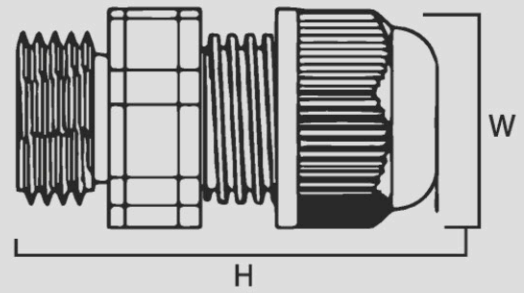
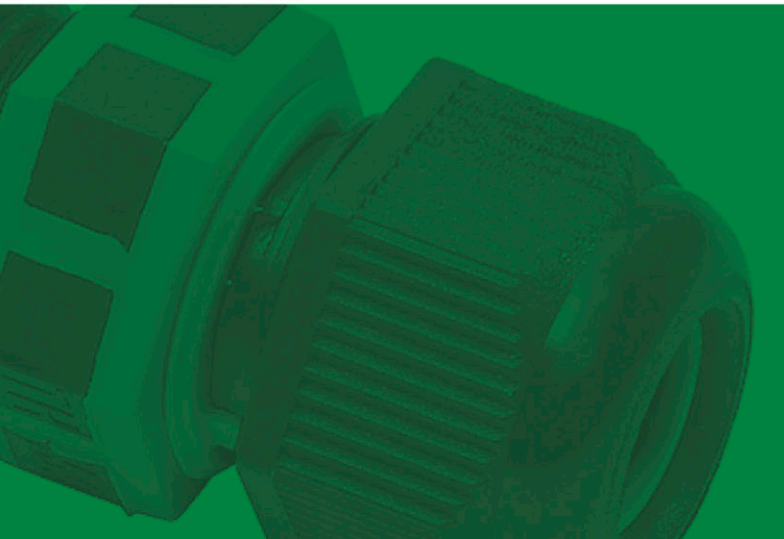

PG TEEGLANDS

Product Code	IP Rating	Colour	Material	H (mm)	Size	Thread Length (mm)	Cable Diameter (mm)
THA.451.A1A	68	Black	Nylon 66	35	Pg9	8	4 to 7.5
THA.451.A1E	68	Grey	Nylon 66	35	Pg9	8	4 to 7.5
THA.451.B1A	68	Black	Nylon 66	35	Pg9	8	7.5 to 9.5
THA.451.B1E	68	Grey	Nylon 66	35	Pg9	8	7.5 to 9.5
THA.451.A1A	68	Black	Nylon 66	38	Pg13.5	8	2x6mm max
THA.451.A1E	68	Grey	Nylon 66	38	Pg13.5	8	2x6mm max
THA.451.B1A	68	Black	Nylon 66	38	Pg13.5	8	7 to 10.5
THA.451.B1E	68	Grey	Nylon 66	38	Pg13.5	8	7 to 10.5
THA.451.B1A	68	Black	Nylon 66	38	Pg13.5	8	10.5 to 14
THA.451.B1E	68	Grey	Nylon 66	38	Pg13.5	8	10.5 to 14
THA.452.A2A	68	Black	Nylon 66	38	Pg16	8	2x6mm max
THA.452.A2E	68	Grey	Nylon 66	38	Pg16	8	2x6mm max
THA.452.B2A	68	Black	Nylon 66	38	Pg16	8	7 to 10.5
THA.452.B2E	68	Grey	Nylon 66	38	Pg16	8	7 to 10.5
THA.452.B2A	68	Black	Nylon 66	38	Pg16	8	10.5 to 14
THA.452.B2E	68	Grey	Nylon 66	38	Pg16	8	10.5 to 14



2 Hole Insert

IP68 TEETUBE



Features:

- Tough, robust construction with large cable range acceptance.
- Straight through, T splitter and Y splitter versions available.
- Dual terminal versions available for easy fitting and looping of conductors (2+2 and 3+3 poles).
- Temperature rating of -40°C to +125°C.
- Micro sized connectors including chassis mount options now available in 2 - 4 pole.
- XDry series anti condensation connectors now available in 4 pole micro size connectors for chassis-mount and in-line applications.

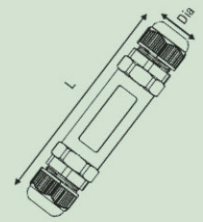

TTK STANDARD SERIES

STANDARD SERIES

Product Code	IP Rating	Poles	Colour	Material	Cable Entries	Insert Type	W (mm)	Ø (mm)	L (mm)
TTK20BK-SD	68 to 5 Bar	3	Black	Nylon 66	2	Barrier	N/A	26.5	115
TTK20GY-SD	68 to 5 Bar	3	Grey	Nylon 66	2	Barrier	N/A	26.5	115
TTK25BK-SD	68 to 5 Bar	5	Black	Nylon 66	2	Barrier	N/A	32	130
TTK25GY-SD	68 to 5 Bar	5	Grey	Nylon 66	2	Barrier	N/A	32	130



TH390 SERIES

THB.390.A1B	68 to 5 Bar	2	Black	Nylon 66	2	Barrier	N/A	30	82
THB.390.A1A	68 to 5 Bar	3	Black	Nylon 66	2	Barrier	N/A	30	82
THB.390.C1B	68 to 2 Bar	2	Black	Nylon 66	3	Barrier	92	30	73
THB.390.C1A	68 to 2 Bar	3	Black	Nylon 66	3	Barrier	92	30	73



TH391 MICRO TEETUBE SERIES

THB.391.A2A	68 to 3 Bar	2	Black/Green (seals)	Nylon 66	2	Barrier		23	68
THB.391.A3A	68 to 3 Bar	3		Nylon 66	2	Barrier		23	68
THB.391.A4A	68 to 3 Bar	4		Nylon 66	2	Barrier		23	68
THB.391.L2A	68 to 3 Bar	2		PA66/TPE	2	Barrier			
THB.391.L3A	68 to 3 Bar	3		PA66/TPE	2	Barrier			
THB.391.L4A	68 to 3 Bar	4		PA66/TPE	2	Barrier			
THB.391.R4A	68 to 3 Bar	4		PA66/TPE	2	Barrier			
THB.391.T4A	68 to 3 Bar	4		PA66/TPE	2	Barrier			

Patented



THB.399 LONG SERIES

THB.399.A3A	68 to 2 Bar	3	Black	Nylon 66	3	Barrier	63	33	180
THB.399.A5A	68 to 2 Bar	5	Black	Nylon 66	3	Barrier	63	33	180
THB.399.A6A	68 to 2 Bar	6	Black	Nylon 66	3	Barrier	63	33	180
THB.399.A9B	68 to 2 Bar	3+3	Black	Nylon 66	3	Through	63	33	180
THB.399.D3A	68 to 2 Bar	3	Black	Nylon 66	3	Barrier	63	33	180
THB.399.D5A	68 to 2 Bar	5	Black	Nylon 66	3	Barrier	63	33	180
THB.399.D6A	68 to 2 Bar	6	Black	Nylon 66	3	Barrier	63	33	180
THB.399.D9B	68 to 2 Bar	3+3	Black	Nylon 66	3	Through	63	33	180



THB.399 SHORT SERIES

THB.399.E3A	68 to 2 Bar	3	Black	Nylon 66	3	Barrier	63	33	125
-------------	-------------	---	-------	----------	---	---------	----	----	-----

THB.402 SERIES

THB.402.C1B	68 to 2 Bar	2	Black	Nylon 66	3	Barrier	92	26	121
THB.402.C1A	68 to 2 Bar	3	Black	Nylon 66	3	Barrier	92	26	121
THB.402.C2E	68 to 2 Bar	3+3	Black	Nylon 66	3	Through	92	26	121
THB.402.D1F	68 to 2 Bar	5	Black	Nylon 66	3	Barrier	92	26/32	121
THB.402.D1G	68 to 2 Bar	6	Black	Nylon 66	3	Barrier	92	26/32	121
THB.402.D2E	68 to 2 Bar	3+3	Black	Nylon 66	3	Through	92	26/32	121



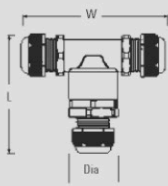

TH390 SERIES

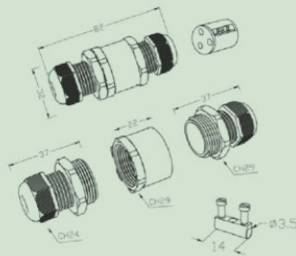

TH390 SERIES

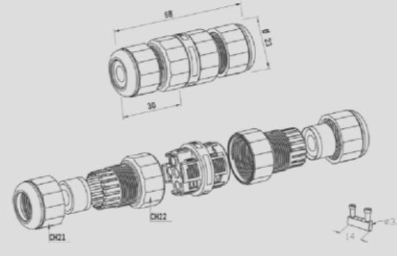

TH391, MICRO TEETUBE SERIES

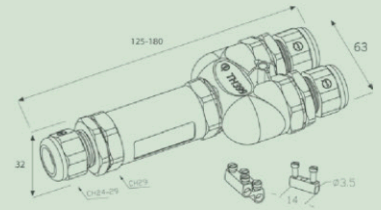

TH399 SERIES

	Min - Max Cable Diameter (mm)	Max Conductor Size (mm ²)	Max Current (A)	Description
	5 - 13	4	32	Standard black 3 pole Teetube supplied complete with mounting kit
	5 - 13	4	32	Standard grey 3 pole Teetube supplied complete with mounting kit
	8 - 17	4	32	Standard black 5 pole Teetube supplied complete with mounting kit
	8 - 17	4	32	Standard grey 5 pole Teetube supplied complete with mounting kit
	7 - 13.5	4	32	Miniature in-line cable connector
	7 - 13.5	4	32	
	7 - 13.5	4	32	T Style Miniature cable splitter/connector
	7 - 13.5	4	32	
	7 - 12	4	32	Micro Teetube IP68 2 pole in-line cable connector
	7 - 12	4	32	Micro Teetube IP68 3 pole in-line cable connector
	7 - 12	4	32	Micro Teetube IP68 4 pole in-line cable connector
	7 - 12	4	17.5	Micro TeeTube IP68 2 Pole through chassis connector, includes fixing locknut
	7 - 12	4	17.5	Micro TeeTube IP68 3 Pole through chassis connector, includes fixing locknut
	7 - 12	4	17.5	Micro TeeTube IP68 4 Pole through chassis connector, includes fixing locknut
	7 - 12	4	17.5	Micro TeeTube IP68 4 pole in-line XDry series anti condensation connector
	7 - 12	4	17.5	Micro TeeTube IP68 4 pole chassis mount XDry series anti condensation connector
	7 - 13.5*	4	32	Y Style Cable splitter/connector, long tube
	7 - 13.5*	4	32	Y Style Cable splitter/connector, long tube
	7 - 13.5*	4	32	Y Style Cable splitter/connector, long tube
	7 - 13.5*	4	32	Y Style Cable splitter/connector, long tube
	8 - 17**	4	32	Y Style Cable splitter/connector, long tube
	8 - 17**	4	32	Y Style Cable splitter/connector, long tube
	8 - 17**	4	32	Y Style Cable splitter/connector, long tube
	8 - 17**	4	32	Y Style Cable splitter/connector, long tube
	7 - 13.5	2.5	32	Miniature Y Style Cable splitter/connector
	7 - 13.5	4	32	T Style Cable splitter/connector, long tube
	7 - 13.5	4	32	T Style Cable splitter/connector, long tube
	7 - 13.5	4	32	T Style Cable splitter/connector, long tube
	7 - 13.5 (2)/8 - 17 (1)	4	32	T Style splitter/connector, long tube, 8 - 17mm cable ø, T Bar 7 - 13.5mm cable ø
	7 - 13.5 (2)/8 - 17 (1)	4	32	T Style splitter/connector, long tube, 8 - 17mm cable ø, T Bar 7 - 13.5mm cable ø
	7 - 13.5 (2)/8 - 17 (1)	4	32	T Style splitter/connector, long tube, 8 - 17mm cable ø, T Bar 7 - 13.5mm cable ø

* Was 5mm minimum, but now use accessory 6000087LF for cable ø less than 7mm

** Was 5mm minimum, but now use accessory 6000087LF for cable ø less than 8mm

TEEPLUGS



Features:

- Up to IP68 versions available.
- Various configurations available.
- Components are keyway coded to ensure correct assembly.
- All products are quick and simple to install.
- Bulkhead/chassis mount options available (depending on product type).
- Temperature range of -20°C to +125°C.
- Chassis mount and in-line Micro series TeePlugs with 5 poles now available.



TH380 SERIES

Product Code	Poles	IP Rating	Colour	Material	Ø (mm)	L (mm)
THB.380.A2A	2	20	Black	Nylon 66	19	33
THB.380.A1A	3	20	Black	Nylon 66	19	33
THB.380.B2A	2	20	Black	Nylon 66	19	33
THB.380.B1A	3	20	Black	Nylon 66	19	33

TH382 SERIES

THB.382.A2A	2	40	Black	Nylon 66	19	53
THB.382.A1A	3	40	Black	Nylon 66	19	53
THB.382.B2A	2	40	Black	Nylon 66	19	53
THB.382.B1A	3	40	Black	Nylon 66	19	53

TH384 SERIES

THB.384.A2A	2	68 to 5 Bar	Black	Nylon 66	27	55
THB.384.A1A	3	68 to 5 Bar	Black	Nylon 66	27	55
THB.384.B2A	2	68 to 5 Bar	Black	Nylon 66	27	55
THB.384.B1A	3	68 to 5 Bar	Black	Nylon 66	27	55
THB.384.3KIT	3	68 to 5 Bar	Black	Nylon 66	27	55

TH385 SERIES - PANEL MOUNT CONNECTORS, MINIMUM REAR PROFILE

THB.385.A2A	2	68 to 5 Bar	Black	Nylon 66	28	35
THB.385.A1A	3	68 to 5 Bar	Black	Nylon 66	28	35

TH386 SERIES - PANEL MOUNT - SELF LOCKING

THB.386.A2A	2	67	Black	Nylon 66	30	35
THB.386.A1A	3	67	Black	Nylon 66	30	35
60B01070C			Black	Nylon 66		

TH387 MICRO TEEPLUG SERIES

THB.387.A4A	4	66/68 to 3 Bar	Black	Nylon 66	23	52
THB.387.B4A	4	66/68 to 3 Bar		Nylon 66	23	33
THB.387.C4A	4	66/68 to 3 Bar		Nylon 66	23	33
THB.387.D4A	4	66/68 to 3 Bar		Nylon 66	23	33
THB.387.E4A	4	66/68 to 3 Bar	Black/Green (seals)	PA66	24	34
THB.387.E5A	5	66/68 to 3 Bar		PA66	24	34
THB.387.F4A	4	66/68 to 3 Bar		PA66	24	34
THB.387.F5A	5	66/68 to 3 Bar		PA66	24	34
THB.387.C5A-KIT	5	66/68 to 3 Bar		PA66	24	34
THB.387.D5A-KIT	5	66/68 to 3 Bar		PA66	24	34
THB.387.A5A	5	66/68 to 3 Bar		PA66	23	52
THB.387.B5A	5	66/68 to 3 Bar		PA66	23	49



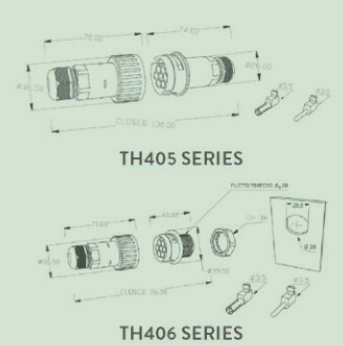
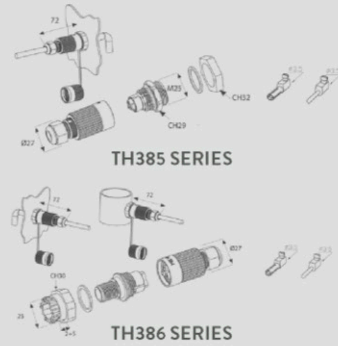
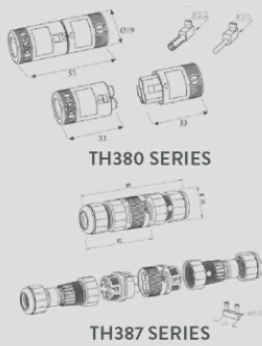

	Min - Max Cable Diameter (mm)	Max Conductor Size (mm ²)	Max Current (A)	Max Voltage (V)	Description
	10 Max	4.0	17.5	400	Plug
	10 Max	4.0	17.5	400	Plug
	10 Max	4.0	17.5	400	Socket
	10 Max	4.0	17.5	400	Socket
	7 - 9.5	4.0	17.5	400	Plug
	7 - 9.5	4.0	17.5	400	Plug
	7 - 9.5	4.0	17.5	400	Socket
	7 - 9.5	4.0	17.5	400	Socket
	7 - 12	4.0	17.5	400	Plug
	7 - 12	4.0	17.5	400	Plug
	7 - 12	4.0	17.5	400	Socket
	7 - 12	4.0	17.5	400	Socket
	7 - 12	4.0	17.5	400	Plug and Socket Kit. Can also be panel mounted with additional M20 lockout.
	N/A	4.0	17.5	400	Chassis mounting plug supplied complete with locknut. For applicable socket see TH384 series.
	N/A	4.0	17.5	400	Chassis mounting plug supplied complete with locknut. For applicable socket see TH384 series.
	N/A	4.0	17.5	400	Self locking chassis mounting plug (no rear locknut required but requires locking tool/dust cap). For applicable socket see TH384 series.
	N/A	4.0	17.5	400	Self locking chassis mounting plug (no rear locknut required but requires locking tool/dust cap). For applicable socket see TH384 series.
	N/A				Dust Cap/locking tool.
	7 - 12	4	17.5	450	Micro Teeplug IP68 4 pole cable mount Plug connector for use with TH387 series cable mount or chassis mount power sockets shown in this section.
	7 - 12	4	17.5	450	Micro Teeplug IP68 4 pole cable mount Socket connector for use with TH387 series cable mount or chassis mount plugs shown in this section.
	7 - 12	4	17.5	450	Micro Teeplug IP68 4 pole chassis mount Plug connector for use with TH387 series cable mount socket connector shown in this section.
	7 - 12	4	17.5	450	Micro Teeplug IP68 4 pole chassis mount socket connector for use with TH387 series cable mount plug connector shown in this section.
		4	17.5	450	Micro TeePlug Panel mount 4 pole male contacts, mounting nut supplied.
		4	17.5	450	Micro TeePlug Panel mount 5 pole male contacts, mounting nut supplied.
		4	17.5	450	Micro TeePlug Panel mount 4 pole female contacts, mounting nut supplied.
		4	17.5	450	Micro TeePlug Panel mount 5 pole female contacts, mounting nut supplied.
		4	17.5	450	Micro TeePlug Panel mount 5 pole male contacts, mounting nut/screws supplied.
		4	17.5	450	Micro TeePlug Panel mount 5 pole female contacts, mounting nut/screws supplied.
	7 - 12	4	17.5	450	Micro TeePlug 5 pole in-line plug contacts 1 cable entry.
	7 - 12	4	17.5	450	Micro TeePlug 5 pole in-line socket contacts 1 cable entry.

TEEPLUGS



TH405 SERIES

Product Code	Poles	IP Rating	Colour	Material	∅ (mm)	L (mm)
THB.405.A2B	3	68 to 1 Bar	Black	Nylon 66	36.5	74
THB.405.A2A	5	68 to 1 Bar	Black	Nylon 66	36.5	74
THB.405.A2E	6	68 to 1 Bar	Black	Nylon 66	36.5	74
THB.405.B2B	3	68 to 1 Bar	Black	Nylon 66	36.5	70
THB.405.B2A	5	68 to 1 Bar	Black	Nylon 66	36.5	70
THB.405.B2E	6	68 to 1 Bar	Black	Nylon 66	36.5	70
THB.405.A2B-KIT	3	68 to 1 Bar	Black	Nylon 66	36.5	130
THB.405.RPDKIT	5	68 to 1 Bar	Black	Nylon 66	36.5	130
600012200	3					
600009600	5					
6DB00750C	6		Black	Nylon 66		

TH406 SERIES - PANEL MOUNT

THB.406.A1B	3	68	Black	Nylon 66	39.5	40
THB.406.A1A	5	68	Black	Nylon 66	39.5	40
THB.406.A1E	6	68	Black	Nylon 66	39.5	40

TH405 SERIES



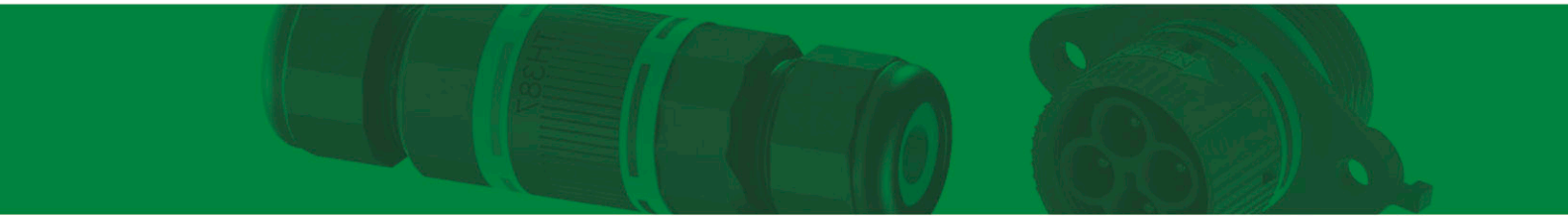

	Min - Max Cable Diameter (mm)	Max Conductor Size (mm ²)	Max Current (A)	Max Voltage (V)	Description
	7 - 14	4.0	25	400	Plug
	7 - 14	4.0	17.5	400	Plug
	7 - 14	4.0	17.5	400	Plug
	7 - 14	4.0	25	400	Socket
	7 - 14	4.0	17.5	400	Socket
	7 - 14	4.0	17.5	400	Socket
	7 - 14	4.0	25	400	Plug & Socket Kit complete with assy tool
	7 - 14	4.0	17.5	400	Plug & Socket Kit complete with assy tool
					3 pole assy tool
					5 pole assy tool
					Combined 6 pole assy tool and dust cap

	N/A	4.0	25	400	Chassis mounting plug supplied complete with anti vibration locknut. Mates to TH405 series power socket
	N/A	4.0	17.5	400	Chassis mounting plug supplied complete with anti vibration locknut. Mates to TH405 series power socket
	N/A	4.0	17.5	400	Chassis mounting plug supplied complete with anti vibration locknut. Mates to TH405 series power socket

TH387 SERIES



TEEBOX

Features:

- Comprehensive range of connection options.
- Protection rating up to IP68 depending on product.
- Unique 3 pole T connector TH029 available for use in TH209 & TH211 range, no cable forming required.
- TH211 available as full KIT version complete with TH029 fitted.
- Power distribution products are available in standard and micro sizes. Standard sizes are TH631 (3 port) and TH623 (4 port). Micro sizes are TH392 (3 and 4 port options). TH392 is also available in XDry, anti condensation versions.
- Temperature range of -20°C to +125°C.

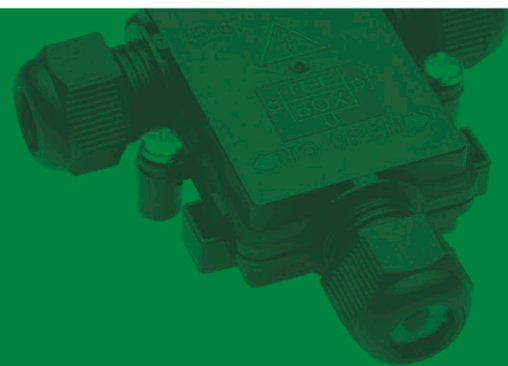

TH110 SERIES

Product Code	IP Rating	Poles	Colour	Material	Cable Entries	Insert Type	H (mm)	W (mm)	L (mm)
THB.110.C3B	44	3	Natural	Nylon 66	2	Through	12.5	27	75
THB.110.C6B	44	3	Natural	Nylon 66	2	Wire Protected	11.5	27	75

TH112 SERIES

THP.112.A3A	54	3	Black	Nylon 66	2	Insulation piercing screw and crimp	12.6	21.2	46.3
6000287CA			Natural	Nylon 66	2		17	36	75

TH200 SERIES

THK.200.C2E	67	3	Black	Nylon 66	3	Barrier	20	41	82
THK.200.3T	67	3	Black	Nylon 66	3	Barrier	20	41	82

TH209 SERIES

THA.209.A1B	54		Black	Nylon 66	4		28	65	108
THA.209.A1A	68		Black	Nylon 66	4		28	65	108
THA.209.A1A8PKIT	68	8	Black	Nylon 66	4	Barrier	28	65	108
THA.209.D1B	54		Black	Nylon 66	3		28	65	108
THA.209.D1A	68		Black	Nylon 66	3		28	65	108

TH211 SERIES

Product Code	IP Rating	Poles	Colour	Material	Cable Entries	Insert Type	H (mm)	W (mm)	L (mm)
THA.211.A1B	54		Black	Nylon 66	3		36	118	137
THA.211.A1A	65		Black	Nylon 66	3		36	118	137
THA.211.A1A3PTK	65	3	Black	Nylon 66	3	Barrier	36	118	137
THA.211.D1B	54		Black	Nylon 66	3		36	118	137
THA.211.D1A	65		Black	Nylon 66	3		36	118	137

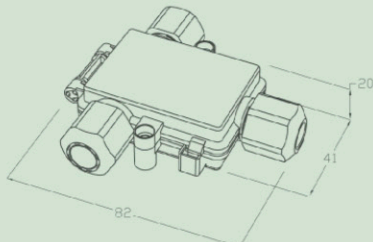

TH200 SERIES

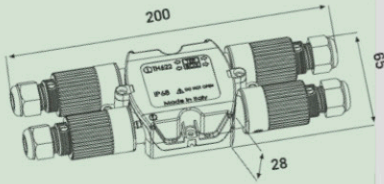

TH62X SERIES

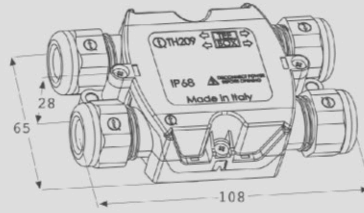

TH209 SERIES

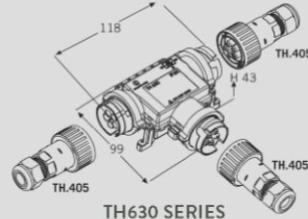

TH630 SERIES

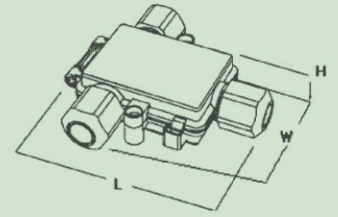

TH209 SERIES

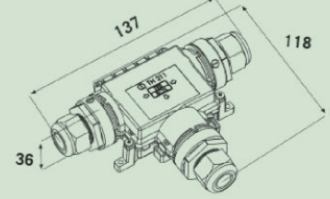

TH211 SERIES

Min - Max Cable Diameter (mm)	Max Conductor Size (mm ²)	Max Current (A)	Max Voltage (V)	Description
9 Max	2.5	24	450	In-line connector with integrated terminals and cable retention clamps.
9 Max	2.5	24	450	In-line connector with integrated terminals and cable retention clamps.
	1.5	17.5	450	Fast fit in-line connector with insulation screw to crimp terminals.
				Screw mount carrier with cable retention clamps for TH112 connectors.
4 - 9.5	2.5	25	450	T splitter (three cables), includes terminal block and fixing kit
4 - 9.5	4.0	32	450	T splitter with unique TH029 T connector fitted
7 - 14				Junction box suitable for use directly with terminal block TH032 or with TH026/TH027 with support plate 6000175CC
7 - 14	4	32	450	Junction box supplied complete with 8 pole (1x3 and 1x5 pole) connector mounted on support plate
7 - 14				Junction box suitable for use directly with terminal block TH032 or with TH026/TH027 with support plate 6000175CC
7 - 14				Junction box suitable for use directly with terminal block TH032 or with TH026/TH027 with support plate 6000175CC
Min - Max Cable Diameter (mm)	Max Conductor Size (mm ²)	Max Current (A)	Max Voltage (V)	Description
8 - 17				Junction box suitable for use directly with terminal block TH029 or with TH026/TH027 with support plate 6000194CC
8 - 17				Junction box suitable for use directly with terminal block TH029 or with TH026/TH027 with support plate 6000194CC
8 - 17	4	32	450	Junction box supplied complete with 3 pole TH029 connector for direct mounting inside unit
7 - 13.5				Junction box suitable for use directly with terminal block TH029 or with TH026/TH027 with support plate 6000194CC
7 - 13.5				Junction box suitable for use directly with terminal block TH029 or with TH026/TH027 with support plate 6000194CC

TEEBOX



POWER DISTRIBUTION UNITS

TH623 SERIES



Product Code	IP Rating	Poles	Colour	Material	Cable Entries	Insert Type	H (mm)	W (mm)	L (mm)
THH.623.L3A	68	3	Black	Nylon 66	4		28	65	200

XDRY/TH392 SERIES



Product Code	IP Rating	Poles	Colour	Material	Cable Entries	Insert Type	H (mm)	W (mm)	L (mm)
THB.392.A4A	68	4	Black and Green	PA66 GF UL94V0/UL94 V2, Caps/ TPE Seals	4	Screw	28	54	80
THB.392.A4B	68	4			3		28	54	80
THB.392.R4A	68	4			4		28	54	80
THB.392.R4B	68	4			3		28	54	80



TH631 SERIES

THH.631.B3A	65	3	Black	Nylon 66	3		43	99	118
THH.631.B5A	65	5	Black	Nylon 66	3		43	99	118
THH.631.B6A	65	6	Black	Nylon 66	3		43	99	118

TYPICAL
APPLICATIONS

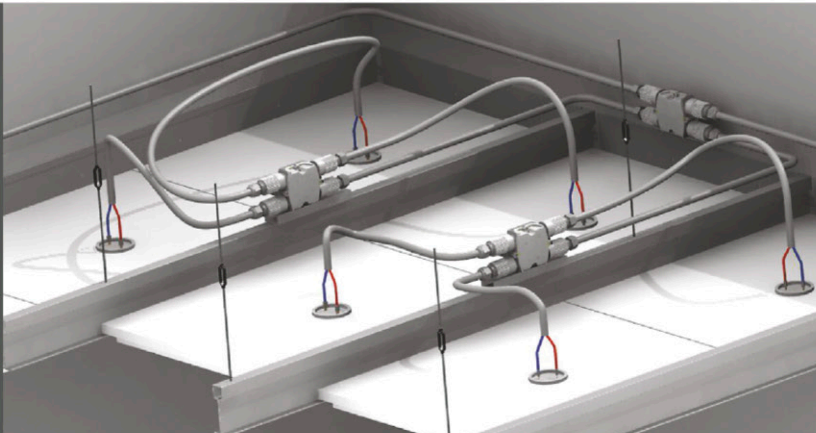

TH622 SERIES FOR
PLUG & PLAY LIGHTING
POWER DISTRIBUTION



Min - Max Cable Diameter (mm)	Max Conductor Size (mm ²)	Max Current (A)	Max Voltage (V)	Description
7 - 12	4.0	17.5	400	3 pole power distribution box, 1x input, 3x output (Four cables). 17.5A max input. Supplied complete with pre-cabled box and 4 connectors

Min - Max Cable Diameter (mm)	Max Conductor Size (mm ²)	Max Current (A)	Max Voltage (V)	Description
8 - 12	4	17.5	450	Micro series power distributor, 1 input 3 output, sealed connections, IP68
8 - 12	4	17.5	450	Micro series power distributor, 1 input 2 output, sealed connections, IP68
8 - 12	4	15	450	Micro XDry series anti condensation power distributor, 1 input 3 output, sealed connections, IP68
8 - 12	4	15	450	Micro XDry series anti condensation power distributor, 1 input 2 output, sealed connections, IP68

7 - 14	4	25	400	Power distribution box, 1x input, 2x output (Three cables). 25A max input. Supplied complete with pre-cabled box and 3 connectors
7 - 14	4	17.5	400	Power distribution box, 1x input, 2x output (Three cables). 17.5A max input. Supplied complete with pre-cabled box and 3 connectors
7 - 14	4	17.5	400	Power distribution box, 1x input, 2x output (Three cables). 17.5A max input. Supplied complete with pre-cabled box and 3 connectors

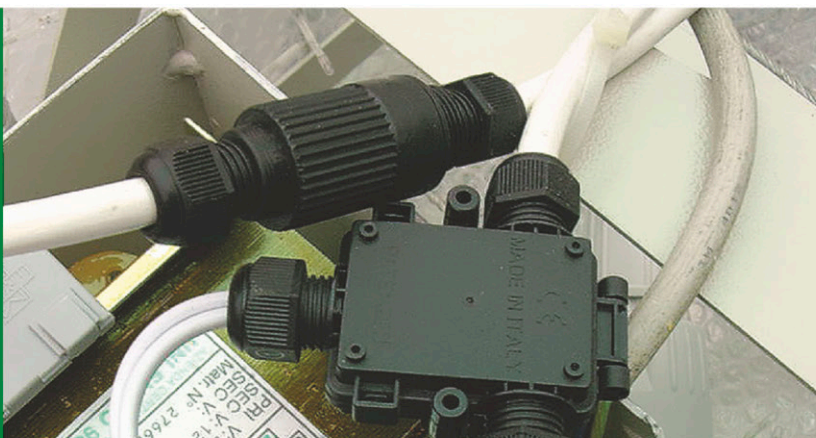

TH200 AND TH384 USED IN HVAC MODULAR INSTALLATION AND POWER DISTRIBUTION PROJECT

TEEBLOCK

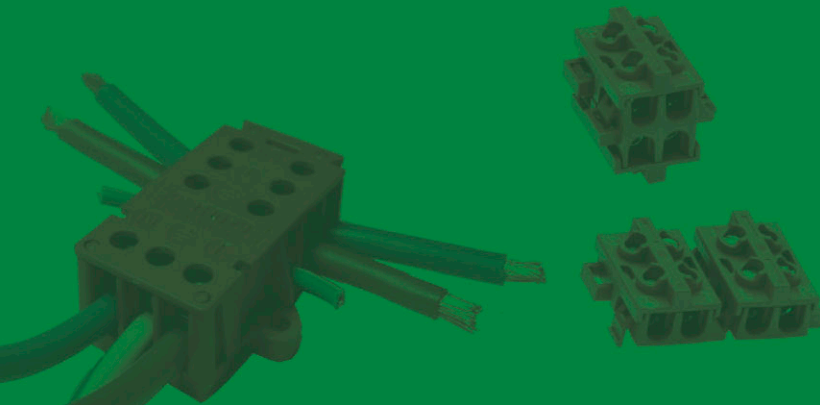

Features:

- Unique T style connector TH029 saves installation time and effort.
- Range includes insulation piercing options.
- Large conductor size capability with rising clamp fitting of TH027 enables easier installation.
- The 3 and 5 pole options of TH026 gives flexibility of configuration when used with the TeeBox.
- TH032, 4+4 terminals colour for LED applications.
- Ideal for use the LED lighting or Digital Addressable Lighting Interface control applications.



TH026 STYLE PA66 FV 125°C



Product Code	Poles	Colour	Material	H (mm)	W (mm)	L (mm)	Insert Type
THB.026.A1A	5	Brown	Nylon 66 V0	16.4	20.6	32	Through
THB.026.A2A	5	Brown	Nylon 66 V0	16.4	20.6	32	Wire Protected
THB.026.B1A	3	Brown	Nylon 66 V0	16.4	20.6	21	Through
THB.026.B2A	3	Brown	Nylon 66 V0	16.4	20.6	21	Wire Protected



TH027 STYLE PA66GF 125°C

THB.027.A1A	3	Brown	Nylon 66GF V0	16	29	43.5	Rising Clamp
-------------	---	-------	---------------	----	----	------	--------------

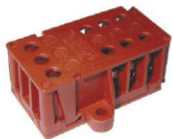

TH029 T STYLE PA66FV 125°C

THB.029.A1A	3	Brown	Nylon 66 V0	15.8	20.6	38.5	Barrier
-------------	---	-------	-------------	------	------	------	---------



TH032 STYLE PA66GF 125°C

THB.032.A4B	4+4	Brown	Nylon 66GF V0	21	20.8	50.7	Barrier
THP.032.A4B	4+4	Brown	Nylon 66GF V0	21	20.8	50.7	Insulation piercing screw & barrier



TH033 STYLE PA66GF 125°C

THB.033.A4A	4	Brown	Nylon 66GF V0	See Line Diagrams for details			Through
THB.033.A4C	4	Brown	Nylon 66GF V0				Wire Protected
THP.033.A4A	4	Brown	Nylon 66GF V0				Insulation piercing screw & barrier

TEEBOX UNITS THAT USE TEEBLOCKS



TH209 WITH 3 POLE HEAVY DUTY CONNECTOR

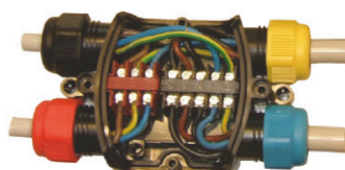

TH209 8 WAY



TH209 4+4 WAY

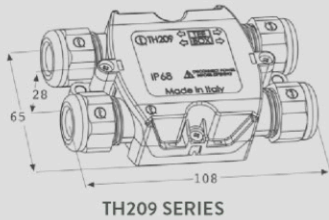

TH209 SERIES

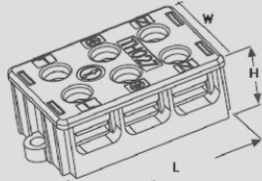

TH027 SERIES

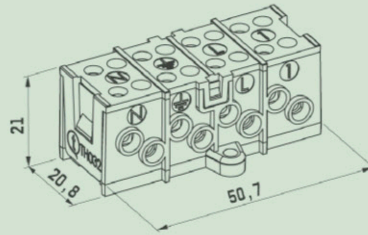

TH032 SERIES

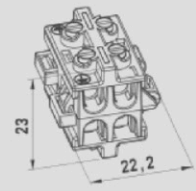
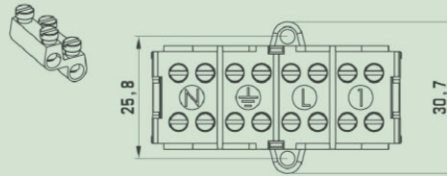

TH033 SERIES

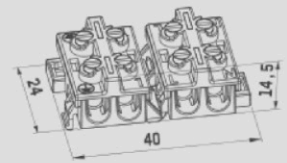

	Max Conductor Size (mm) ²	Max Current (A)	Max Voltage (V)	Description
	4	32	450	ENEC approved Terminal block, for use with TeeBox style Enclosures.
	2.5	24	450	
	4	32	450	
	2.5	24	450	
	6	41	450	Heavy duty terminal block, for use with TeeBox style Enclosures.
	4	32	450	Unique T style terminal block for use with TeeBox style Enclosures especially TH211 for ease of cabling without forming.
	4	32	450	Four pole terminal block with two conductor positions per pole on both connecting faces. Suitable for use in TH209 and TH211 TeeBox.
	1.5	17.5	450	Four pole insulation piercing terminal block with two conductor positions per pole on both connecting faces Suitable for use in TH209 and TH211 TeeBox.
	4	32	450	Four pole terminal block in 2x2 pole hinged configuration. Can be mounted independently or clipped together to use in large (32mm) TeeTube products.
	2.5	24	450	
	1.5	17.5	450	

POWER DISTRIBUTION CONNECTORS



TH211 SERIES WITH T CONNECTOR



TH631 WITH TH405 CONNECTORS



TH623 WITH TH384 CONNECTORS

TEEDRUM



Features:

- The TeeDrum solution can be used as a stand alone connector or installed in TeeTube.
- TeeDrum solutions have been designed to guarantee safety and reliability of the connections.
- The combination of the TeeDrum & TeeTube solution offers protection up to IP68.
- TH021 is finger safe.

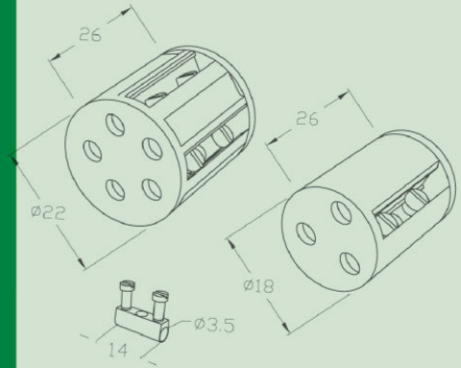

TH020 SERIES

FINGER SAFE



TEEDRUM - SEMI-HOUSED

Product Code	IP Rating	Poles	Colour	Material	Ø (mm)	L (mm)	Insert Type
THB.021.C1A	20	2	Black/Brown	Nylon 66	22	26	Barrier
THB.021.A1A	20	3	Black	Nylon 66	22	26	Barrier
THB.021.B1A	20	5	Black	Nylon 66	26	26	Barrier

TEEDRUM

THB.020.A1A	00	3	Black	Nylon 66	18	26	Barrier
THB.020.B1A	00	5	Black	Nylon 66	22	26	Barrier
THB.020.D1A	00	6	Brown	Nylon 66	22	26	Barrier
THB.020.C2A	00	3+3	Brown	Nylon 66	22	26	Through

TEEDRUM - SEMI-HOUSED MOUNTING RAILS

6000048KC							
6000047KC							

TEETUBES THAT USE TEEDRUMS



TH390 SERIES



TH390 SERIES



TH399 SERIES

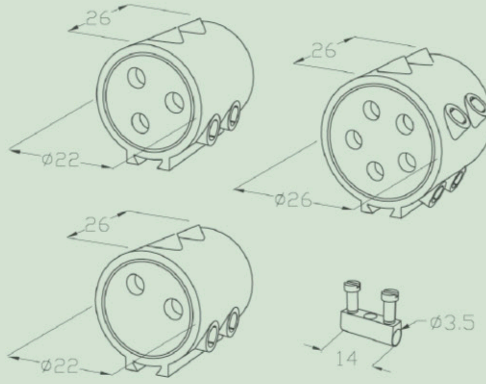
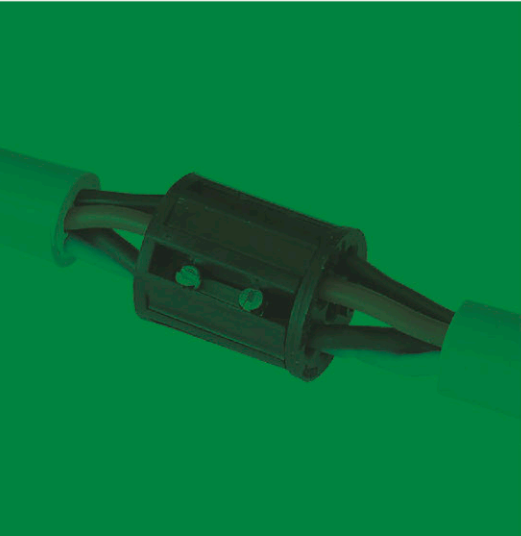

TH021 SERIES



	Max Conductor Size (mm)	Max Current (A)	Max Voltage (V)	Description
	4	32	450	Semi housed Cylindrical terminal block. Suitable for stand-alone use or in conjunction with mounting rail accessories as below.
	4	32	450	
	4	32	450	
	4	32	450	Cylindrical terminal block. 3 Poles with 2 conductor connections per pole.
	4	32	450	
	4	32	450	
	4	32	450	



TH399 MINI SERIES



TH402 SERIES



TTK20 & TTK25 SERIES

WEATHERPROOF RANGE ACCESSORIES

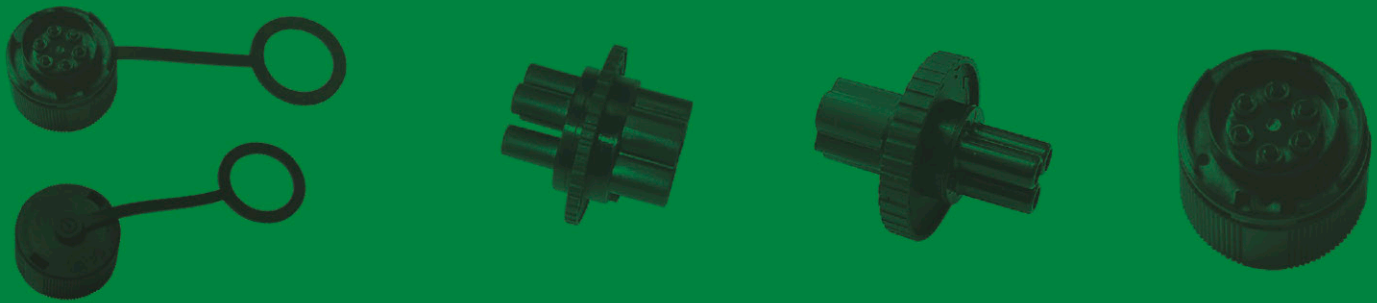

WEATHERPROOF RANGE ACCESSORIES

Product Code	Suitable for Product Types	Poles	Description
600009600	TH405		5 pole assembly tool
600012200	TH405		3 pole assembly tool
6DB00200C	TH384		Dust Cap c/w silicon strap. *Also acts as a locking tool for TH386, Black
6DB00750C	TH405		Combined 6 pole assy tool and cap
6000194CC	TH211		Support plate for use with terminal blocks TH026 or TH027 when mounted in these junction boxes
6000183CC	TH384, TH385, TH386		Dust cap only
6DB00900C	TH405, TH406		Dust cap complete with silicon belt
6000049CC	TH405, TH406		Dust cap only

ALTERNATIVE INSERTS FOR USE WITH TEE PRODUCTS

6DB000800	Not for use with TH110, TH112		Double Yellow seal, cable range 5 - 13.5mm diameter	
604001800			Yellow seal, cable range 9 - 13.5mm diameter	
6000087LF			Reducing insert cap, Hole diameter 9mm	
600012500		TH200, TH382		2 Hole Insert, 3.5mm diameter
600012600		TH384, TH385		3 Hole Insert, 3.5mm diameter
600018200		TH386, TH388		4 Hole Insert, 3.5mm diameter
600013700			Blind insert	
6000086MH	TH384, TH385, TH386		Green Seal single hole for cable diameter 4 - 6mm	
6000085MM			Blue Seal single hole for cable diameter 6 - 7.5mm	
6000084MG			Yellow Seal single hole for cable diameter 7.5 - 9.5mm	
6000091MA			White Seal blanking plug	
6000114MA			White Seal 2 hole diameter 2mm	
6000089MA			White Seal 2 hole diameter 3.5mm	
6000090MA			White Seal 1 hole diameter 2mm	
6000106MA			White Seal 3 hole diameter 3.5mm	
6000113MA			White Seal 4 hole diameter 2mm	
6000040LF				Green blanking cap
6000042LF				Green reducing adapter, 6mm diameter hole
6000041LF				Green reducing adapter, 7.5mm diameter hole



IP68 GEL FILLED CONNECTORS

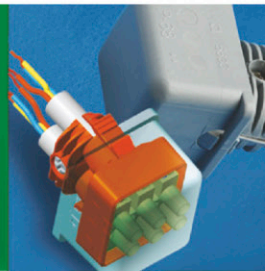
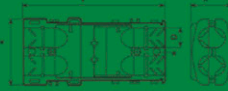

Patented

Features:

- Can be rewired without renewal of internal gel.
- IP68 Protection as standard.
- Supplied complete with connector.
- Ideal for external connection applications.
- The products can be buried without moisture ingress problems.
- Up to 25 Amp current capability, depending on product. Nylon PA66 V0 options available.
- Easier conductor terminations for looping and parallel connections on 3+3 and 2+2 terminal products.
- 2, 3 and 4 cable options now available.

5625 SERIES

Product Code	IP Rating	Poles	Terminal Type	Colour	Material	Cable Entries	H (mm)	W (mm)	L (mm)	Cable Diameter (mm)	Max Conductor Size (mm)	Max Current (A)	Max Voltage (V)
5625/////1121	68	3	Screw	Black	Nylon 66-RV	4	24	44	105	6.5 - 12	4	16	250
5625/4151121	68	4	Screw	Black	Nylon 66-RV	4	24	44	105	6.5 - 12	2.5	16	250

5630 SERIES

5630/////26	68	2	Screw	Black	Nylon 66-RV	2	22	37	45	5.3 - 8.5	2.5	16	250
-------------	----	---	-------	-------	-------------	---	----	----	----	-----------	-----	----	-----

5633 SERIES

5633/////86	68	3	Screw	Grey	Nylon 66-RV	2	30	39	45	8 - 10	2.5	16	250
5633/6/86	68	4	Screw	Grey	Nylon 66-RV	2	30	39	45	8 - 10	2.5	16	250

5650 SERIES

5650/////221	68	6	Screw	Black	Nylon PA66 V0	2	29	29	100	6.5 - 12	0.5	6	24
5650/3/221	68	3	Screw	Black	Nylon PA66 V0	2	29	29	100	6.5 - 12	2.5	6	250
5650/20/221	68	2	Screw	Black	Nylon PA66 V0	2	29	29	100	6.5 - 12	1.5	16	250

5660 SERIES

5660/2///221	68	2	Screw	Black	Nylon PA66 V0	2	41	40	120	7.5 - 16	6	25	450
5660/3///221	68	3	Screw	Black	Nylon PA66 V0	2	41	40	120	7.5 - 16	4	25	450
5660/4///221	68	3	Screw	Black	Nylon PA66 V0	4	35	78	138	7.5 - 16	4	16	250
5660/4/2/221	68	3+3	Screw	Black	Nylon PA66 V0	4	35	78	138	7.5 - 16	6	16	250
5660/5///221	68	5	Screw	Black	Nylon PA66 V0	4	35	78	138	7.5 - 16	2.5	16	250

5663 SERIES

5663/////221	68	3	Screw	Black	Nylon PA66 V0	3	67	40	120	7.5 - 16*, 6.5 - 12**	6	25	450
5663/3///221	68	3	Screw	Black	Nylon PA66 V0	3	67	40	120	6.5 - 12*, 6.5 - 12**	2.5	25	450

* Main through cable ** Branch cable

5664 SERIES

5664/////221	68	4	Screw	Black	Nylon PA66 V0	4	19.5	30.5	80	4.5 - 7.5	1	6	250
5664/20/221	68	2+2	Screw	Black	Nylon PA66 V0	4	19.5	30.5	80	4.5 - 7.5	1	6	250

5665 SERIES

5665/221	68	2	Screw	Black	Nylon 66-RV	2	17.5	18	44	4.8 - 6	2.5	10	250
----------	----	---	-------	-------	-------------	---	------	----	----	---------	-----	----	-----



5630 SERIES

5650 SERIES

5660 SERIES

5663 SERIES

5664 SERIES

5665 SERIES

STEATITE HIGH TEMPERATURE TERMINAL BLOCKS

Features:

- Chemical Resistance.
- Nonflammable.
- Heat resistance.
- Dimensional stability up to 800°C.
- Temp Rating of -40°C to +300-350°C.
- Available with steel inserts



STEATITE TERMINAL BLOCKS FOR HIGH TEMPERATURE APPLICATIONS

Product Code	Poles	Colour	Material	H (mm)	W (mm)	L (mm)	Fixing Holes Diameter	Standard Conductor size (mm ²)	Max Conductor size (mm ²)	Max current
DESTB-0251	1	Beige/Matt	Steatite	15.6	18	10	N/A	4	6	32
DESTB-0401	1	Beige/Matt	Steatite	21	22	11	N/A	10	10	41
DESTB-0252	2	Beige/Matt	Steatite	15.6	18	21	4.5	4	6	32
DESTB-0402	2	Beige/Matt	Steatite	21	22	24	5.4	10	10	41
DESTB-1002	2	Beige/Matt	Steatite	23	30	34	5.2	10	16	57
DESTB-0253	3	Beige/Matt	Steatite	15.6	18	32	4.5	4	6	32
DESTB-0403	3	Beige/Matt	Steatite	21	22	38	5.4	6	10	41
DESTB-1003	3	Beige/Matt	Steatite	23	30	52	5.2	10	16	57
DESTB-0254	4	Beige/Matt	Steatite	15.6	18	43	4.5	4	6	32
DESTB-0404	4	Beige/Matt	Steatite	21	22	52	5.4	6	10	41

1-4 POLE STEATITE
TERMINAL BLOCK
FOR HIGH TEMPERATURE
APPLICATIONS

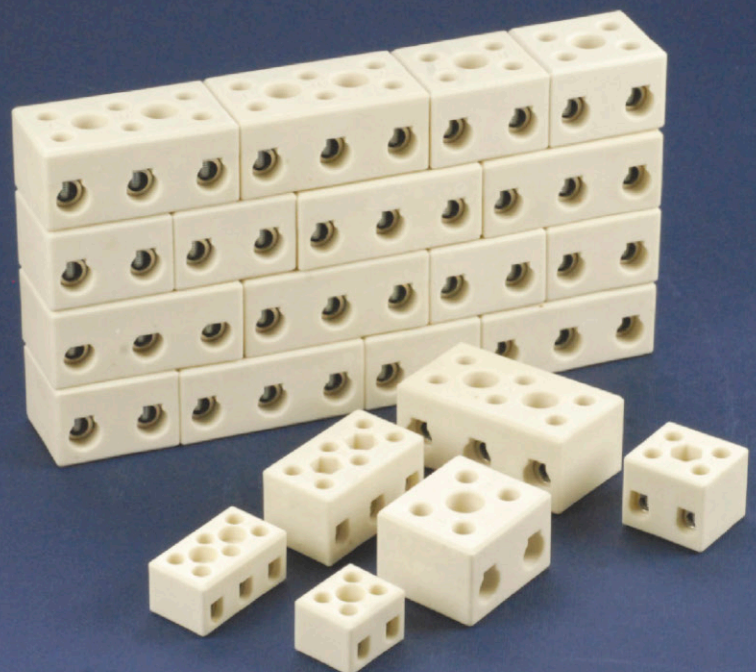



STEATITE CERAMIC TERMINAL BLOCKS WITH STEEL INSERTS

Product Code	Poles	Colour	Material	H (mm)	W (mm)	L (mm)	Fixing Holes Diameter	Standard Conductor size (mm ²)	Max Conductor size (mm ²)	Max current
DESTB-0252-ST	2	White	Steatite	15.6	18	21	4.5	4	4	32
DESTB-0253-ST	3	White	Steatite	15.6	18	32	4.5	4	4	32
DESTB-0402-ST	2	White	Steatite	23	29.5	33.5	5.4	10	6	41
DESTB-0403-ST	3	White	Steatite	23	29.5	52	5.4	6	6	41

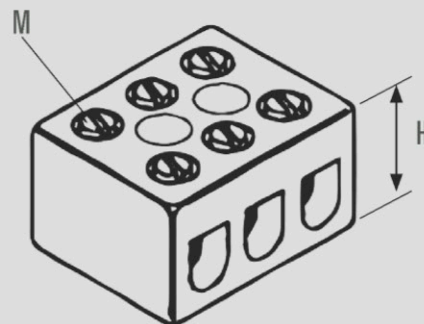
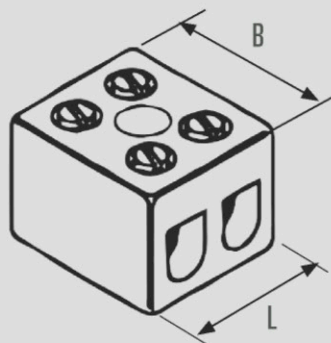

POLYPROPYLENE PILLAR TERMINAL BLOCKS



VDE APPROVED KWIK SNAP TERMINAL BLOCKS IN POLYPROPYLENE



Product Code	Colour	Terminal style	Material	H (mm)	W (mm)	L (mm)
HYKS-02412PP	White	Through hole	Polypropylene	12.2	17.8	93.5
HYKS-03212PP				14	20	116.5
HYKS-05712PP				16.3	23.4	139.3
HYKS-07612PP				20.9	27.7	169.5

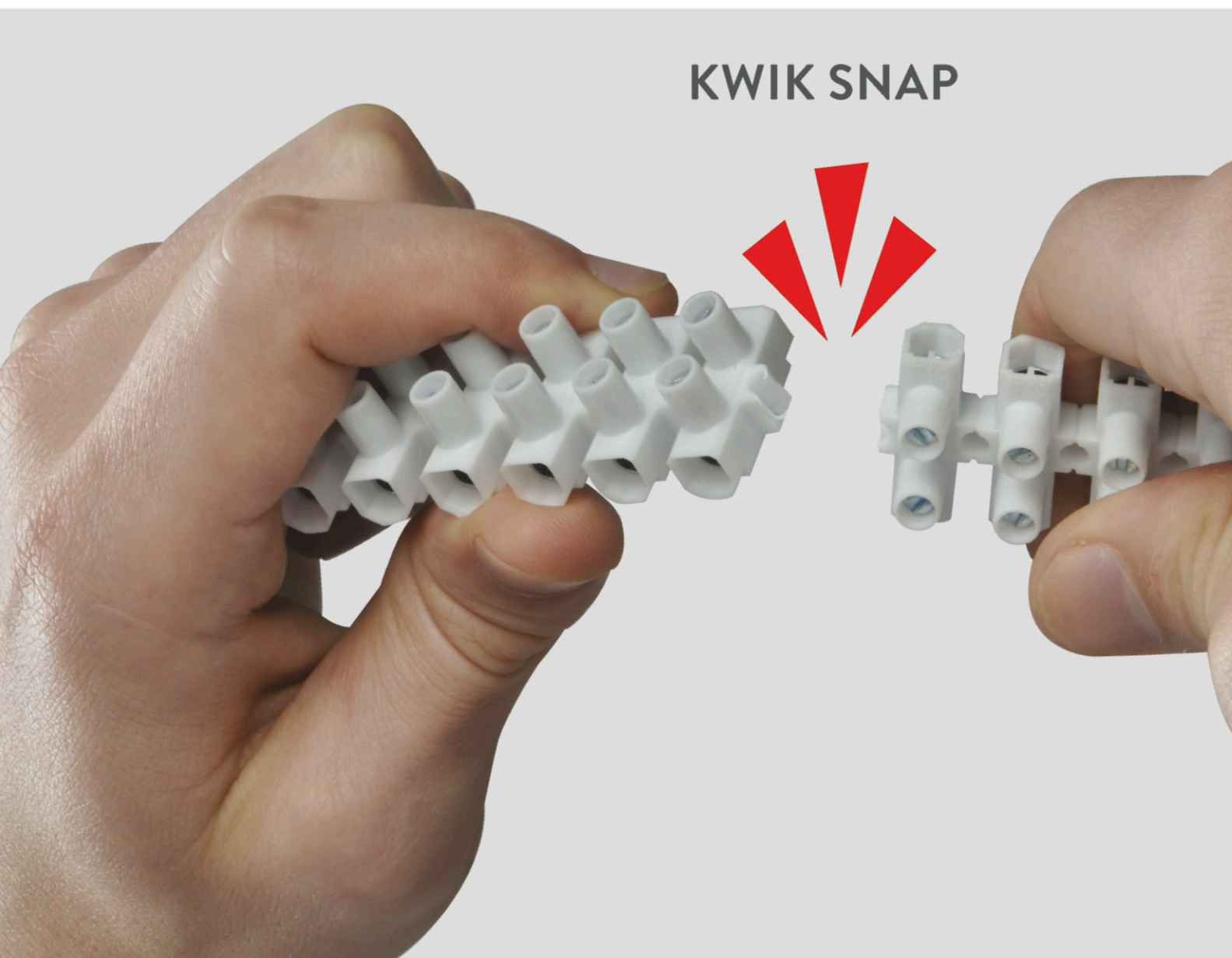

Features:

- New Kwik Snap range saves time, saves money.
- Large diverse range of pillar style terminal blocks available.
- Product available in nylon PA66 and no flame, depending on item.
- Steel insert products available.
- Raised base is standard across range.

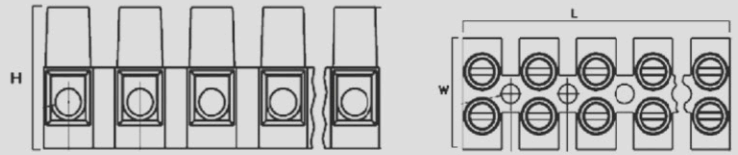

	Fixing Hole (mm)	Pitch (mm)	Flammability Rating	Max Conductor Size (mm)	Max Current (A)	Max Voltage (V)	Poles	Temp Rating
	3.2	8	94 - V2	4.0	24	450	12	85°C to 110°C
	3.2	10	94 - V2	6.0	32	450	12	85°C to 110°C
	4.0	12	94 - V2	10.0	57	450	12	85°C to 110°C
	4.0	14.5	94 - V2	16.0	76	450	12	85°C to 110°C



- KWIK SNAP IS A RANGE OF POLYPROPYLENE TERMINAL BLOCKS THAT CAN BE 'SNAPPED' INTO USABLE POLE SIZES WITHOUT TOOLS BUT WITH THE POLE DIVIDERS STILL BEING CAPABLE OF SUPPORTING FIXING SCREWS. SUPPLIED IN 24-76 AMP OPTIONS, THESE PRODUCTS OFFER A SUPERIOR QUALITY WITH A RAPID INSTALLATION.

NYLON & POLYPROPYLENE PILLAR TERMINAL BLOCKS



12 WAY PLUG & SOCKET CONNECTOR STRIP

Product Code	Colour	Description	Material				
HY431/12 PLPSP	White	Plug and socket	Polypropylene	15	16.3	95.2	
HY431/12 NYSP			Polyamide	15	16.3	95.2	
HY431/12 FVSP			Polyamide	15	16.3	95.2	
HY433/12 PLPSP			Polypropylene	16.6	20.2	116.5	
HY433/12 NYSP			Polyamide	16.6	20.2	116.5	
HY433/12 FVSP			Polyamide	16.6	20.2	116.5	
HY434/12 PLPSP			Polypropylene	20.3	23.2	140.4	
HY434/12 NYSP			Polyamide	20.3	23.2	140.4	
HY434/12 FVSP			Polyamide	20.3	23.2	140.4	
HY115/12 PLPSP			Polypropylene	18	23.1	180.5	
HY115/12 NYSP			Polyamide	18	23.1	180.5	
HY115/12 FVSP			Polyamide	18	23.1	180.5	



IP30 PLUG & SOCKET LIGHTING CONNECTORS

Product Code	Colour	Poles	Material	Flammability Rating	Max Conductor Size (mm)	
HYGST-30PSK	Black	3	Polyamide	UL94-V2	2.5	
HYGST-3LPSK		3		UL94-V2	2.5	
HYGST-4LPSK		4		UL94-V2	2.5	
HYGST-5LPSK		5		UL94-V2	2.5	

IP30 PLUG & SOCKET LIGHTING CONNECTORS

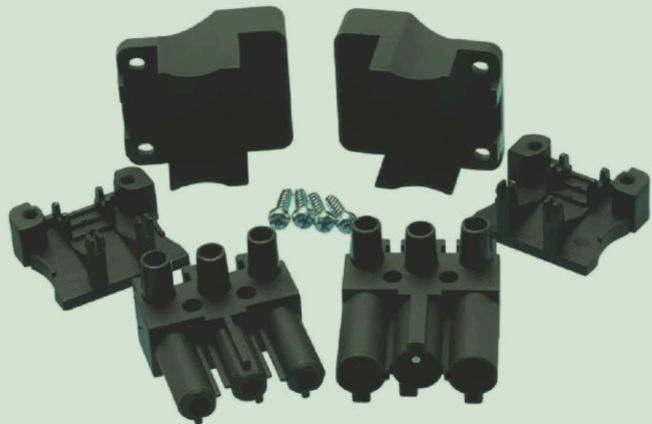

Features:

- 12 way pillar plug and socket terminal strip can be cut to pole lengths required.
- IP30 GST plug and socket connectors in 3,4 & 5 pole with latch options for lighting applications.
- Modular assembly allows rapid disconnection/
reconnection for testing and/or replacement units.
- GST Style connectors VDE Approved to mate with Wieland and Adels equivalents.
- High temperature pillar plug and socket connectors rated to 150°.

			Flammability Rating		Max Current (A)			Temp Rating
	2.8	8	UL94 V2		24	450	2 - 3 - 4 - 6 - 12	85°C
	2.8	8	UL94 V2		24		2 - 3 - 4 - 6 - 12	125°C
	2.8	8	UL94 V0		24		2 - 3 - 4 - 6 - 12	150°C
	3.4	10	UL94 V2		28		2 - 3 - 4 - 6 - 12	85°C
	3.4	10	UL94 V2		28		2 - 3 - 4 - 6 - 12	110°C
	3.4	10	UL94 V0		28		2 - 3 - 4 - 6 - 12	150°C
	4.1	12	UL94 V2		45			85°C
	4.1	12	UL94 V2		45			110°C
	4.1	12	UL94 V0		45			150°C
	3.5	12	UL94 V2		35		2 - 4 - 6 - 16	85°C
	3.5	12	UL94 V2		35		2 - 4 - 6 - 16	110°C
	3.5	12	UL94 V0		35		2 - 4 - 6 - 16	150°C

	Max Current (A)	Max Voltage (V)	Temp Rating	Description
	16	250	110°C Max	Plug and socket including covers
	16	250	110°C Max	
	16	250	110°C Max	
	16	250	110°C Max	

12 WAY PLUG & SOCKET CONNECTOR STRIP

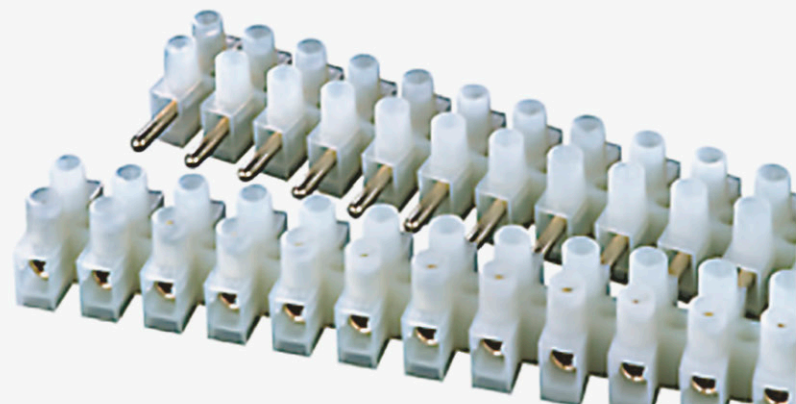

FUSED PILLAR BLOCKS

Features:

- Optional earth screw versions available.
- Wire protected versions available.
- Available in 1-5 poles depending on version chosen.
- UL94 V0 rated as standard.
- Wide working temperature range.
- Spare fuse retention clip included in fuse holder.



FUSED PILLAR BLOCKS, FUSE SIZE 5X20MM

Product Code	Colour	Terminal style	Material	H (mm)	W (mm)	L (mm)	
DFTBN/1	Grey	Interlocking, 1 Pole	Polyamide UL94-V0	20mm	28mm	20.5mm	
DFTBN/2		2 Pole		20mm	28mm	30.5mm	
DFTBN/3		With earth screw, 3 Pole		20mm	28mm	40.5mm	
DFTBN/4		With earth screw, 4 Pole		20mm	28mm	50.5mm	
DFTBN/5		With earth screw, 5 Pole		20mm	28mm	60.5mm	
DFTBN/3NE		No earth, 3 Pole		20mm	28mm	40.5mm	
DFTBN/4NE		No earth, 4 Pole		20mm	28mm	50.5mm	
DFTBN/5NE		No earth, 5 Pole		20mm	28mm	60.5mm	
DFTBN/2WP		Wire Protector, No earth 2 Pole		20mm	28mm	30.5mm	
DFTBN/3WP		Wire Protector, No earth 3 Pole		20mm	28mm	40.5mm	
DFTBN/4WP		Wire Protector, No earth 4 Pole		20mm	28mm	50.5mm	
DFTBN/5WP		Wire Protector, No earth 5 Pole		20mm	28mm	60.5mm	
DFTBN/3EWP		Wire Protected terminals, with earth screw 3 Pole		20mm	28mm	40.5mm	
DFTBN/4EWP		Wire Protected terminals, with earth screw 4 Pole		20mm	28mm	50.5mm	
DFTBN/5EWP		Wire Protected terminals, with earth screw 5 Pole		20mm	28mm	60.5mm	
DFTBN/3EWPG		WP on all poles & inc. earth screw 3 Pole		20mm	28mm	40.5mm	
DFTBN/4EWPG		WP on all poles & inc. earth screw 4 Pole		20mm	28mm	50.5mm	
DFTBN/5EWPG		WP on all poles & inc. earth screw 5 Pole		20mm	28mm	60.5mm	

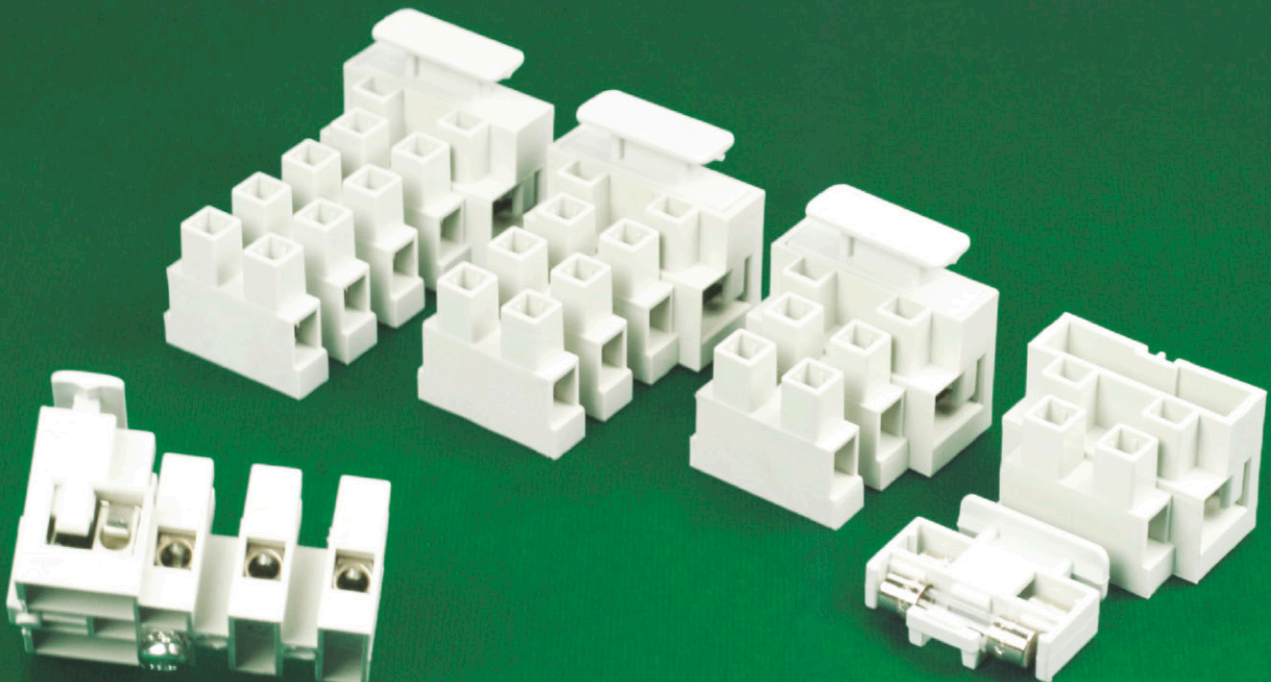

Fixing Hole Dia (mm)	Pitch (mm)	Flammability Rating	Max Conductor Size (mm)	Max Current (A)	Max Voltage (V)	Poles	Temp Rating
	10	UL94-V0	4	Fuseholder 13A Terminal 20A	Fuseholder 250V Terminal 450V	1	-20°C to +120°C
	10	UL94-V0	4			2	-20°C to +120°C
3.3	10	UL94-V0	4			3	-20°C to +120°C
3.3	10	UL94-V0	4			4	-20°C to +120°C
3.3	10	UL94-V0	4			5	-20°C to +120°C
3.3	10	UL94-V0	4			3	-20°C to +120°C
3.3	10	UL94-V0	4			4	-20°C to +120°C
3.3	10	UL94-V0	4			5	-20°C to +120°C
	10	UL94-V0	2.5			2	-20°C to +120°C
3.3	10	UL94-V0	2.5			3	-20°C to +120°C
3.3	10	UL94-V0	2.5			4	-20°C to +120°C
3.3	10	UL94-V0	2.5			5	-20°C to +120°C
3.3	10	UL94-V0	2.5			3	-20°C to +120°C
3.3	10	UL94-V0	2.5			4	-20°C to +120°C
3.3	10	UL94-V0	2.5			5	-20°C to +120°C
3.3	10	UL94-V0	2.5			3	-20°C to +120°C
3.3	10	UL94-V0	2.5	4	-20°C to +120°C		
3.3	10	UL94-V0	2.5	5	-20°C to +120°C		

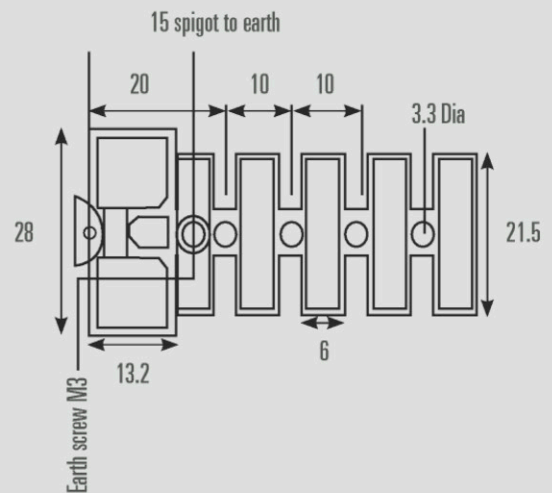
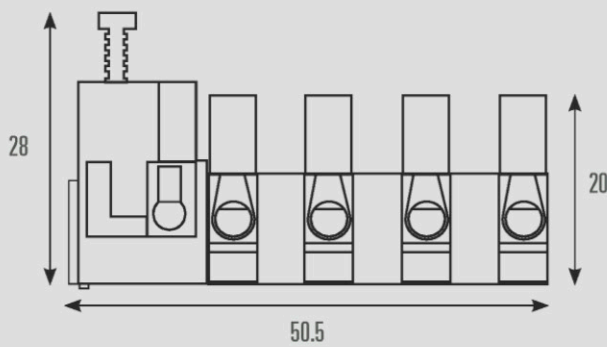

SCREW TO TAB TERMINAL BLOCKS

Features:

- High temperature versions available to 150°.
- Earth foot option available on some versions.
- Shorting link options available on some versions.
- Multi tab connectors on output side as standard.
- DIN Rail mount modular system also available.



SCREW TO SCREW TERMINAL BLOCKS

Product Code	Colour	Terminal style	Material	H (mm)	W (mm)	L (mm)
FV110 V/V	Red/Brown	Screw to Screw	Polyamide Glass Fibre reinforced	24	31.5	81.3
FV173 V/V				24	31.5	99
FV122 V/V				24	31.5	134.4



SCREW TO TAB TERMINAL BLOCKS WITH SNAP-IN FEET

FV273 S/3P	Red/Brown	Screw to Tab	Polyamide Glass Fibre reinforced	23	38.5	59.8
FV273 S/6P				23	38.5	114

SCREW TO TAB TERMINAL BLOCKS



FV110	Red/Brown	Screw to Tab	Glass-fibre reinforced polyamide	24	31.5	81.3
FV122				24		134.4
FV173				24	31.5	99
FV273/3				21		82
FV273/4				21		100
FV273/5				21		118
FV273/6				21		136
FV273/7				21		154
FV77/2				21.3	24	25
FV77/3				21.3	24	41
FV77/4				21.3	24	57





Fixing Hole (mm)	Tab size (mm)	Flammability Rating	Max Conductor Size (mm)	Max Current (A)	Max Voltage (V)	Poles	Temp Rating
6x7.5		UL94-V0	6	40	450	3	-5°C to +150°C
6x7.5		UL94-V0	6	40	450	4	-5°C to +150°C
6x7.5		UL94-V0	6	40	450	6	-5°C to +150°C

N/A	6.3x0.8	UL94-V0	6	41	450	3	-5°C to +150°C
N/A	6.3x0.8	UL94-V0	6	41	450	6	-5°C to +150°C

6	6.3x0.8	UL94-V0	6	40	450	3	-5°C to +150°C
6	6.3x0.8	UL94-V0	6	40	450	6	-5°C to +150°C
6	6.3x0.8	UL94-V0	6	40	450	4	-5°C to +150°C
5.5	6.3x0.8	UL94-V0	6	41	450	3	-5°C to +150°C
5.5	6.3x0.8	UL94-V0	6	41	450	4	-5°C to +150°C
5.5	6.3x0.8	UL94-V0	6	41	450	5	-5°C to +150°C
5.5	6.3x0.8	UL94-V0	6	41	450	6	-5°C to +150°C
5.5	6.3x0.8	UL94-V0	6	41	450	7	-5°C to +150°C
	6.3x0.8	UL94-V0	4	25	450	2	-5°C to +150°C
	6.3x0.8	UL94-V0	4	25	450	3	-5°C to +150°C
	6.3x0.8	UL94-V0	4	25	450	4	-5°C to +150°C

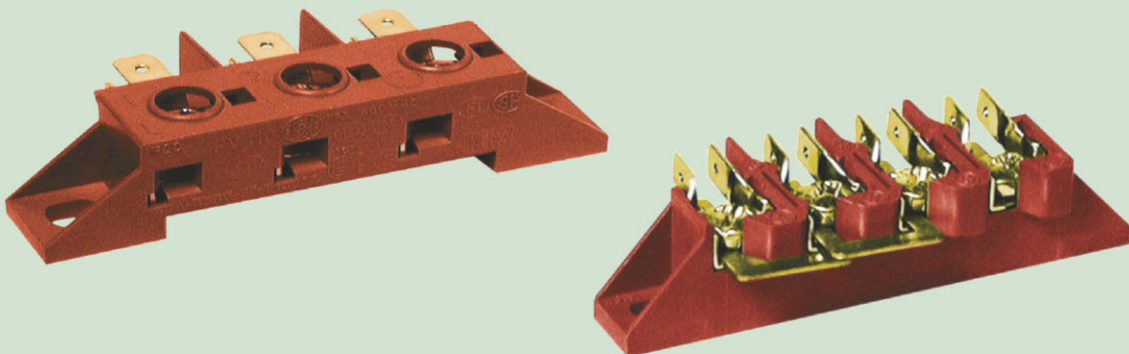

SCREW TO TAB TERMINAL BLOCKS AND TAB TO TAB TERMINAL BLOCKS

SCREW TO TAB TERMINAL BLOCKS WITH EARTH BRACKET

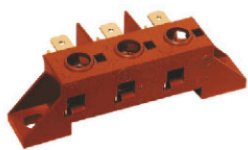

Product Code	Colour	Terminal style	Material	H (mm)	W (mm)	L (mm)
FV110/B	Red/Brown	Screw to Tab	Glass fibre reinforced polyamide	24	31.5	81.3
FV122/B				24		134.4
FV173/B				24	31.5	99
FV273/3B				21		82
FV273/4B				21		100
FV273/5B				21		118
FV273/6B				21		136
FV273/7B				21		154

SCREW TO TAB TERMINAL BLOCKS WITH WIRE PROTECTOR



Product Code	Colour	Terminal style	Material	H (mm)	W (mm)	L (mm)
FV71 WP/3P	Red/Brown	Screw to Tab	Polyamide glass fibre reinforced	26.6	25.5	41
FV77/2WP		Screw to Tab, wire protected	Glass fibre reinforced polyamide	21.3	24	25
FV77/3WP				21.3	24	41
FV77/4WP				21.3	24	57

SCREW TO TAB TERMINAL BLOCK, SNAP IN FEET AND INTEGRATED EARTH BRACKET

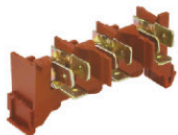

Product Code	Colour	Terminal style	Material	H (mm)	W (mm)	L (mm)
FV273S B/3P	Red/Brown	Screw to Tab	Polyamide glass fibre reinforced	23	38.5	59.8
FV273S B/6P				23	38.5	114

TAB TO TAB TERMINAL BLOCK



Product Code	Colour	Terminal style	Material	H (mm)	W (mm)	L (mm)
PA21	Clear	Tab to Tab	Polyamide	7.5	27	149
PA108			Polyamide	8	54.5	149

DIN RAIL BARRIER TERMINAL BLOCK TAB TO TAB

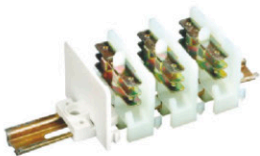

Product Code	Colour	Terminal style	Material	H (mm)	W (mm)	L (mm)
PA80F/F	Clear	Tab to Tab	Polyamide UL94 V2	29	38	11

DIN RAIL BARRIER TERMINAL BLOCK SCREW TO TAB

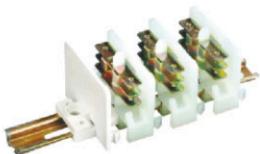

Product Code	Colour	Terminal style	Material	H (mm)	W (mm)	L (mm)
PA80V/F	Clear	Screw to Tab	Polyamide UL94 V2	29	38	11

END PLATE FOR PA80 SERIES

Product Code	Colour	Terminal style	Material	H (mm)	W (mm)	L (mm)
PA81	Clear		Polyamide UL94 V2	29	38	11

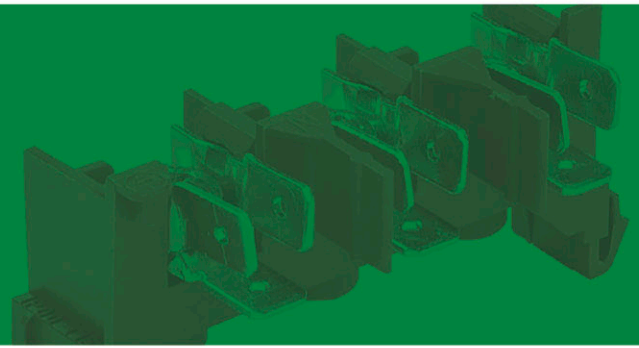

	Fixing Hole (mm)	Tab size (mm)	Flammability Rating	Max Conductor Size (mm)	Max Current (A)	Max Voltage (V)	Poles	Temp Rating
	6	6.3x0.8	UL94-V0	6	40	450	3	-5°C to +150°C
	6	6.3x0.8		6	40	450	6	-5°C to +150°C
	6	6.3x0.8		6	40	450	4	-5°C to +150°C
	5.5	6.3x0.8		6	41	450	3	-5°C to +150°C
	5.5	6.3x0.8		6	41	450	4	-5°C to +150°C
	5.5	6.3x0.8		6	41	450	5	-5°C to +150°C
	5.5	6.3x0.8		6	41	450	6	-5°C to +150°C
	5.5	6.3x0.8		6	41	450	7	-5°C to +150°C

	4.2	6.3x0.8	UL94-V0	6	25	450	3	-5°C to +150°C
		6.3x0.8		4	25	450	2	-5°C to +150°C
		6.3x0.8		4	25	450	3	-5°C to +150°C
		6.3x0.8		4	25	450	4	-5°C to +150°C

	N/A	6.3x0.8	UL94-V0	6	41	450	3	-5°C to +150°C
	N/A	6.3x0.8		6	41	450	6	-5°C to +150°C

	3.3	6.3x0.8	UL94-V2	N/A	15	450	12	-5°C to +150°C
	3.3	6.3x0.8			15	450	12	-5°C to +125°C

	Din 15	6.3x0.8	UL94-V2	2.5	24	450	3	-5°C to +150°C
--	--------	---------	---------	-----	----	-----	---	----------------

	Din 15	6.3x0.8	UL94-V2	2.5	24	450	1 Screw, 3 Tabs	-5°C to +150°C
--	--------	---------	---------	-----	----	-----	-----------------	----------------

	Din 15		UL94-V2					-5°C to +150°C
--	--------	--	---------	--	--	--	--	----------------

TERMINAL BOXES

Features:

- A selection of terminal blocks and chassis mount connectors ideal for modular cable assembly.
- Allows flexible assembly and installation of larger systems and equipment, efficient and fast manufacture process.
- Current rating up to 41A depending on product.
- All products carry relevant approvals.



TERMINAL BOX WITH INTEGRATED CABLE CLAMP AND INTERNAL SCREW TO TAB OR TAB TO TAB TERMINALS

Product Code	Colour	Material	H (mm)	W (mm)	L (mm)	Fixing Hole (mm)
PA104	White	Polyamide UL94 V2	107	66	23.5	5.5
PA109	Clear	Polyamide PA6.6		65.5	118.5	



TERMINAL BOX WITH INTEGRATED CABLE CLAMP AND GROUNDING PLATE. FOR SNAP IN FIXING CHASSIS

Product Code	Colour	Material	H (mm)	W (mm)	L (mm)	Panel cut out diameter* (mm)
PA223/3SN	Black	Polyamide UL94 V2	82.8	53.8	34	50.5x82.5
PA223/6SN			82.8	53.8	34	50.5x82.5

*See relevant product data sheet for cut-out details.



TERMINAL BOX FOR SNAP IN CHASSIS FIXING

PA4542	Black	Polyamide UL 94 V2	82.8	53.8	31	50.5x82.5
PA244/S			60.5	37.5	40.8	
PA244 N			35	38	49.2	N/A
FX5244 A		Polyamide PA6.6	26	54	106	Panel cut out 48.2x95
PA299			21	37	100	
PA299 C			21	37	81	
PA189			21	43	67	
PA289			21	70.5	77	

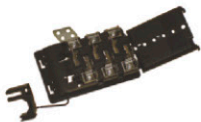

TERMINAL BOX FOR SNAP IN CHASSIS FIXING WITH RAST5 CONNECTION

PA4668	Black	Polyamide UL 94 V2	82.8	53.8	31	50.5x82.5
PA4682			81.8	55.7	24.8	50.5x82.5



2 POLE TERMINAL BLOCK WITH INTEGRATED CABLE CLAMP, FOR SNAP IN FIXING ON CHASSIS, 16A

PA84NRSV	Black	Polyamide UL94 V2	29	29	68.5	26x23
----------	-------	-------------------	----	----	------	-------



2 POLE TERMINAL BLOCK WITH INTEGRATED CABLE CLAMP, FOR SNAP IN FIXING ON CHASSIS, 16A WITH EARTH BRACKET

PA84NRSVE	Black	Polyamide UL94 V2	29	29	68.5	26x23
-----------	-------	-------------------	----	----	------	-------

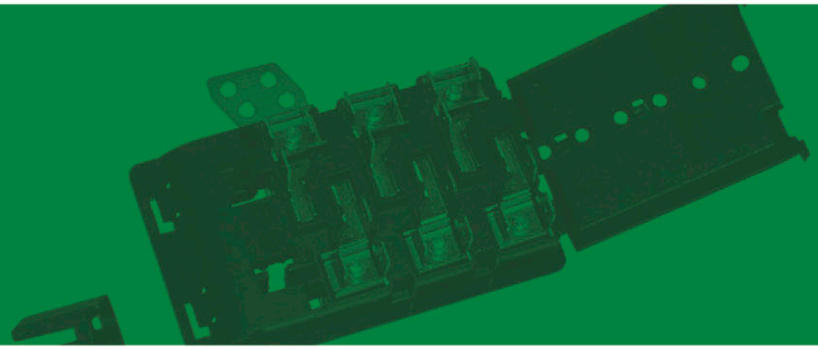

	Tab size (mm)	Flammability Rating	Max Conductor Size (mm)	Max Current (A)	Max Voltage (V)	Poles	Temp Rating
	6.3x0.8	UL94 V2	1.5	16	450	6	-5 - + 85 DegC
		UL94-V2	4	24	450	5	-5 to +125

	Panel cut out thickness (mm)	Flammability Rating	Max Conductor Size (mm)	Max Current (A)	Max Voltage (V)	Poles	Temp Rating
	0.8 - 1.5	UL94 V2	6	40	450	3	-5°C to +125°C
	0.8 - 1.5	UL94 V2	6	40	450	6	-5°C to +125°C

	0.8 - 1.5	UL94 V2	6	41	450	3	-5°C to +110°C
	0.8 - 1.5	UL94 V2	2.5	16	250	3	-5°C to +125°C
	0.8 - 1.5	UL94-V2	1.5	16	250	3	-5°C to +125°C
	1	UL94-V2	6	35	450	6	-5°C to +125°C
		UL94-V2	1.5	16	450	3	-5°C to +125°C
		UL94-V2	1.5	16	450	3	-5°C to +125°C
		UL94-V2	2.5	16	450	3	-5°C to +125°C
		UL94-V2	4	32	450	5	-5°C to +125°C

	0.8 - 1.5	UL94 V2	6	41	450	3	-5°C to +110°C
	0.8 - 1.5		6	41	450	6	-5°C to +125°C

		UL94 V2	1.5	16	450	1 Pole 2 Tabs	-5°C to +125°C
--	--	---------	-----	----	-----	---------------	----------------

		UL94 V2	1.5	16	450	1 Pole 2 Tabs	-5°C to +125°C
--	--	---------	-----	----	-----	---------------	----------------

KWIK WIRE CONNECTORS

Features:

- Temp range: -20°C to 100°C.
- Colour coded Thermoplastic 94-V2.
- 2 - 8 way commoning blocks - Pushwire.
- Moulded Dovetail for stacking.
- Push insertion and twist release and with test slot.
- Solid core conductor only.



HOW THESE CONNECTORS WORK

These push-wire commoning connectors are intended for use with solid core conductors.

Fast installation is ensured as there is no screwing down to clamp the conductors; simply strip the wires and push the conductor securely into the connector. The conductor is held in position by a spring that pushes it against a conducting contact ensuring a good solid connection. Ideal for quick distribution of power, the connectors are available in 2, 3, 4, 5 & 8 way formats and can be neatly stacked via the dove tail slide and groove when the installation is complete.

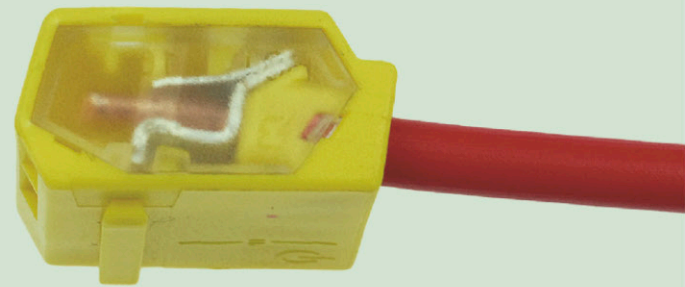

KWIK WIRE CONNECTORS

Product Code	Colour	Wire Entries	H (mm)	W (mm)	L (mm)	Max Conductor Size (mm)	Max Current (A)	Max Voltage (V)
HYKW-02	Red	2	10	18	10	2.5	20	450
HYKW-03	Orange	3	10	18	12	2.5	20	450
HYKW-04	Yellow	4	10	18	17	2.5	20	450
HYKW-05	Grey	5	10	18	20	2.5	20	450
HYKW-08	Black	8	10	18	30	2.5	20	450



KWIK LEVER CONNECTORS



Features:

- Lever-spring clamp action for junction boxes.
- Can be used for stranded cable as well as solid due to the lever-spring clamp action.
- Test Ports to confirm connections
- 2, 3, 5 pole Terminal Block Connector
- Rated at 450V / 32A
- Solid and Stranded conductors: 0.2mm² to 4 mm², 24 to 12 AWG
- Transparent housing supports easy visual inspection
- Simple cable termination with lever operation
- Convenient, Time saving, Efficient, Safe and reliable

KWIK LEVER CONNECTORS

Product Code	Poles	Max Conductor Size (mm)	Conductor Size AWG		Max Current (A)	Max Voltage (V)	Pitch	H (mm)	W (mm)	L (mm)
			Min	Max						
HYKL-02	1 Pole 2 Way	4	24	12	32	450	5.8	9	18	12.4
HYKL-03	1 Pole 3 Way	4	24	12	32	450	5.8	9	18	18.2
HYKL-05	1 Pole 5 Way	4	24	12	32	450	5.8	9	18	24

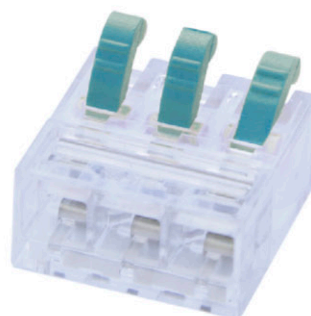

ENCLOSED, NON-REVERSING DOL AC MOTOR STARTERS, IP65

Features:

- CE Approved.
- Supplied with wall/panel facility mounting screw.
- Suitable for most applications including woodworking, dust collecting and metal recycling machinery.
- Simple to use.
- IP65 protected.
- Complete with threaded cable gland entry.
- Wired ready for use with thermal overload relay (purchased separately).



ENCLOSED, NON-REVERSING DOL AC MOTOR STARTERS, IP65

Product Code*	IP Rating	L (mm)	W (mm)	H (mm)	Cable Entries	Temp Range	Enclosure Material	Coil* (V)	3 ϕ Load Power at Voltage					1 ϕ Load Pwr at V		Overload Relay	Inst. Aux. Cont.	
									240V kw/HP	380V kw/HP	400V kw/HP	440V kw/HP	575V kw/HP	120V kw/HP	240V kw/HP		N/O	N/C
DMS1-11D17	65	181	101	130	4	-20°C to +60°C	ABS HB	240	3.0/4.0	5.5/7.5	5.5/7.5	5.5/7.5	5.5/7.5	0.55/0.75	1.5/2	DETH Series	1	-
DMS1-12D17	65	181	101	130	4			240	4.0/5.5	7.5/10	7.5/10	7.5/10	7.5/10	0.75/1	2.2/3		1	-
DMS1-18D17	65	181	101	130	4			240	5.5/7.5	10/15	10/15	10/15	10/15	1.5/2	3.7/5		1	-

*Coil voltages of 110V and 415V are also available. Change part number suffix on part number to /110VAC or /415VAC as appropriate.

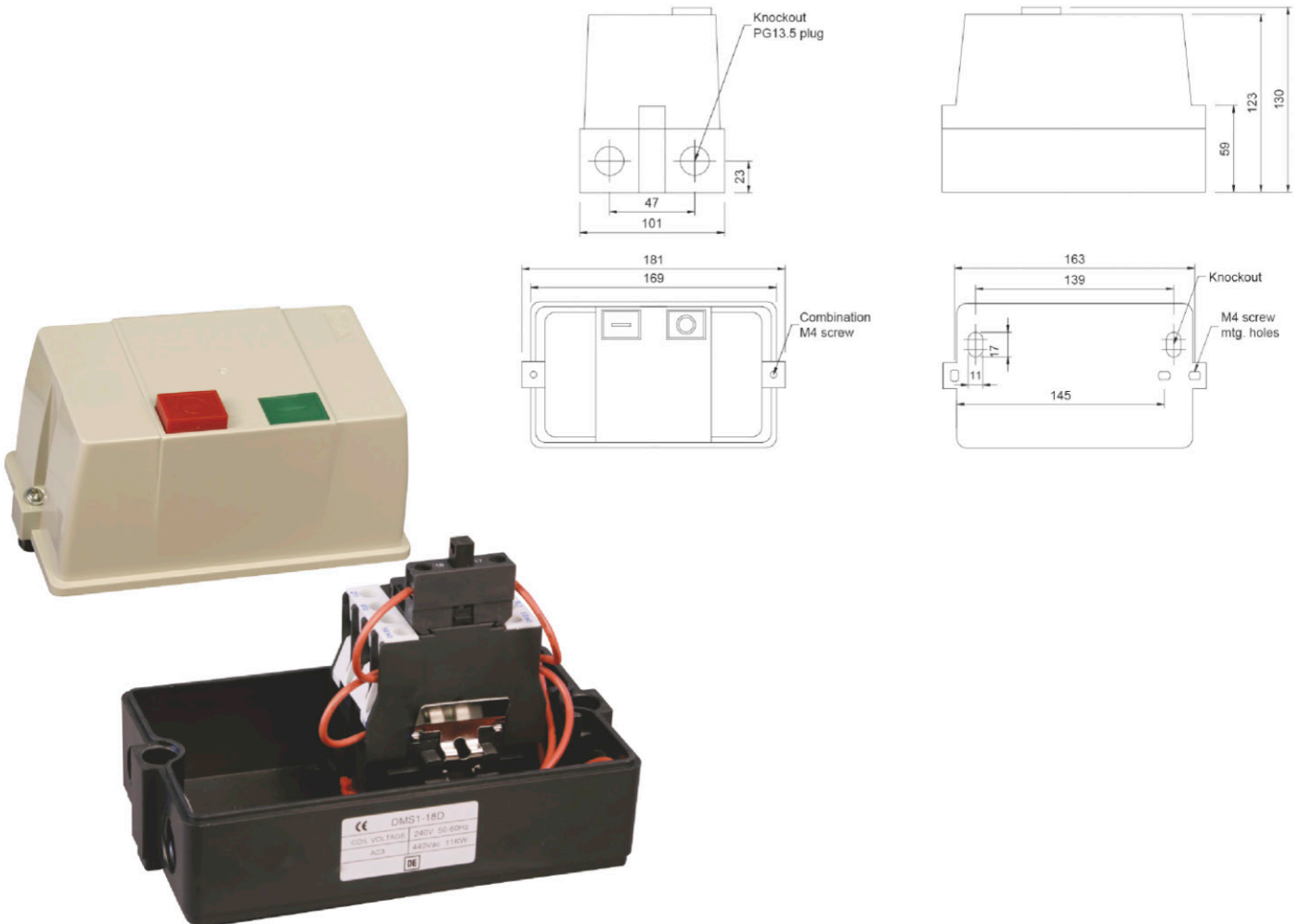

DEC SERIES 3 POLE CONTACTORS (AC3)

Features:

- CSA, CE, UL (listed).
- C/W instantaneous auxiliary contact.
- Temperature range of -20°C to +85°C.
- Combi Head Ready to Tighten Screws.
- Compact design.
- Heavy duty pure Silver point contact.
- IP20 finger protected screws.



DEC SERIES 3 POLE CONTACTORS (AC3)

Product Code*	Unit Wt. (kg)	L (mm)	W (mm)	H (mm)	Temp Range	Instant Aux. Contacts		Rtd. Insulation Voltage (Ui)	AC1 duty $\theta \leq 40^\circ\text{C}$					Rtd. Op. Power AC-3 - 3 Phase					Kg
						N/O	N/C		A - lth	A - le	240V kw/HP	380V kw/HP	400V kw/HP	440V kw/HP	575V kw/HP	120V kw/HP	240V kw/HP		
DEC-11D10/240VAC	0.35	69.3	45.3	79	-25°C to +55°C	1	-	1000V	25	12	3.0/4.0	5.5/7.5	5.5/7.5	5.5/7.5	5.5/7.5	0.55/0.75	1.5/2.0	0.35	
DEC-12D10/240VAC	0.35	69.3	45.3	79		1	-		25	16	4.0/5.5	7.5/10	7.5/10	7.5/10	7.5/10	0.75/1.0	2.2/3.0	0.35	
DEC-18D10/240VAC	0.38	69.3	45.3	84.5		1	-		32	22	5.5/7.5	11/15	11/15	11/15	11/15	1.5/2	3.7/5	0.38	
DEC-25D10/240VAC	0.525	77	56.5	95.5		1	-		40	32	7.5/10	15/20	15/20	15/20	15/20	2.2/3	4/5.5	0.525	
DEC-35D10/240VAC	0.55	77	56.5	100		1	-		50	42	11/15	19/25	19/25	19/25	19/25	3/4	5.5/7.5	0.55	
DEC-45D11/240VAC	1.1	129.3	75	115		1	1		60	55	15/20	30/40	30/40	30/40	30/40			1.1	
DEC-55D11/240VAC	1.1	129.3	75	115		1	1		80	65	19/25	33/45	33/45	33/45	33/45			1.1	
DEC-65D11/240VAC	1.1	129.3	75	115		1	1		90	80	22/30	37/50	37/50	37/50	37/50			1.1	
DEC-80D11/240VAC	1.43	129	81.7	123		1	1		125	105	25/35	45/60	45/60	55/75	55/75			1.43	
DEC-100D11/240VAC	1.43	129	81.7	123		1	1		130	110	30/40	55/75	55/75	55/75	60/80			1.43	

*Coil voltages of 110V and 415V are also available. Change part number suffix to /110VAC or /415VAC as appropriate.

DEC11D/12D

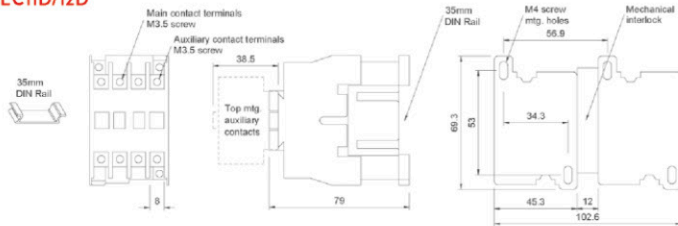

DEC35D

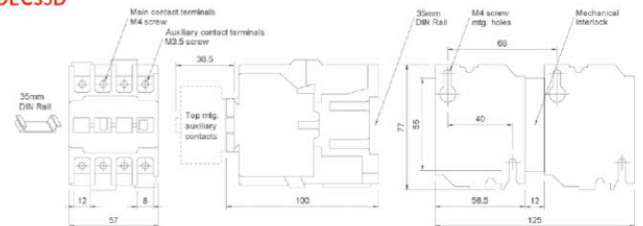

DEC18D

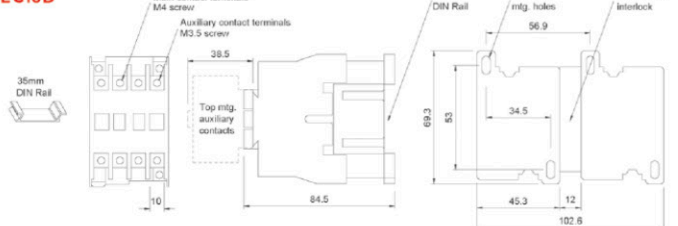

DEC45D/55D/65D

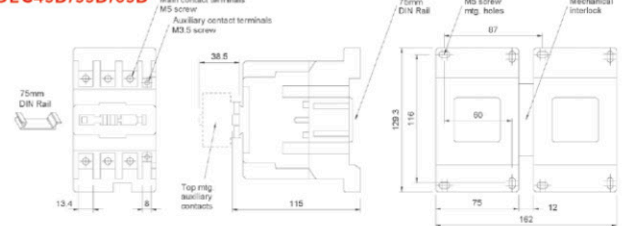

DEC25D

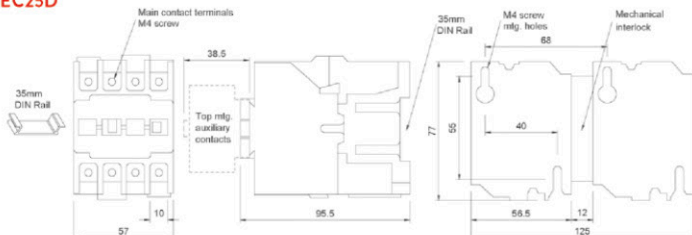

DEC80D/100D

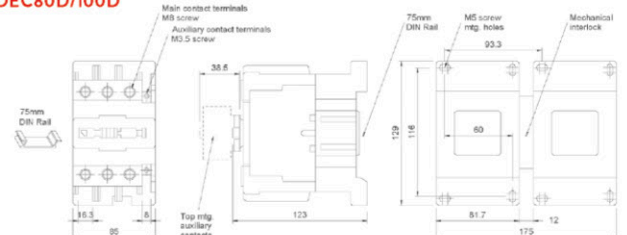

THERMAL OVERLOAD RELAYS DETH SERIES

Compensated and differential overload relays with 1 N/O + 1 N/C electrically separated auxiliary contacts for direct connection with DEC series contactors.

Features:

- Screw terminals IP20 finger protected.
- C/W Lockable & Sealable MAN/AUTO Switch.
- Combi Head Ready open terminals ready to tighten screws.
- 1 minute self reset when tripped.
- Lightweight and simple to use.



THERMAL OVERLOAD RELAYS DETH SERIES

Product Code	Relay Setting Range RC (FLC) A	Aux. Contacts	Aux. contact Type	Rated Insulation Voltage (Ui) Vac	Rated Thermal Current (Ith) A	Body Material	O/L Relay Series	Contactor Type	Weight (kg)	L (mm)	W (mm)	D (mm)
DETH-0.5	0.35 - 0.5	2	N/O + N/C	600	6	Bakelite	DETH	DEC-11D	0.14	93	44	77
DETH-0.75	0.5 - 0.75	2		DEC-11D	0.14			93	44	77		
DETH-1.05	0.75 - 1.05	2		DEC-11D	0.14			93	44	77		
DETH-1.45	1.05 - 1.45	2		DEC-11D	0.14			93	44	77		
DETH-1.9	1.45 - 1.9	2		DEC-11D	0.14			93	44	77		
DETH-2.5	1.9 - 2.5	2		DEC-11D	0.14			93	44	77		
DETH-3	2.4 - 3	2		DEC-11D	0.14			93	44	77		
DETH-4	2.9 - 4	2		DEC-11D	0.14			93	44	77		
DETH-5	3.8 - 5	2		DEC-11D	0.14			93	44	77		
DETH-6.5	4.5 - 6.5	2		DEC-11D	0.14			93	44	77		
DETH-8	6 - 8	2		DEC-11D	0.14			93	44	77		
DETH-11	8 - 11	2		DEC-11D	0.14			93	44	77		
DETH-14	11 - 14	2		DEC-11D/12D	0.14			93	44	77		
DETH-15	10 - 15	2		DEC-12D	0.14			93	44	77		
DETH-17	14 - 17	2		DEC-12D	0.14			93	44	77		
DETH-21	17 - 21	2		DEC-18D	0.15			93	44	77		
DETH-25	21 - 25	2		DEC-18D	0.15			93	44	77		
DETH-28	24 - 28	2		DEC-25D	0.15			93	44	77		
DETH-32	26 - 32	2		DEC-25D	0.15			93	44	77		
DETH-38	30 - 38	2		DEC-35D	0.18			93	44	77		
DETH-44	36 - 44	2	DEC-35D	0.18	93	44	77					
DETH-50	33 - 50	2	DEC-45D	0.427	112	77	57*					
DETH-65	43 - 65	2	DEC-55D	0.427	112	77	57*					
DETH-80	54 - 80	2	DEC-65D	0.427	112	77	57*					
DETH-96	64 - 96	2	DEC-80D	0.427	112	77	57*					
DETH-126	85 - 126	2	DEC-100D	0.427	112	77	57*					

* Without pins

DETH SERIES 0.5 - DETH 44 SERIES

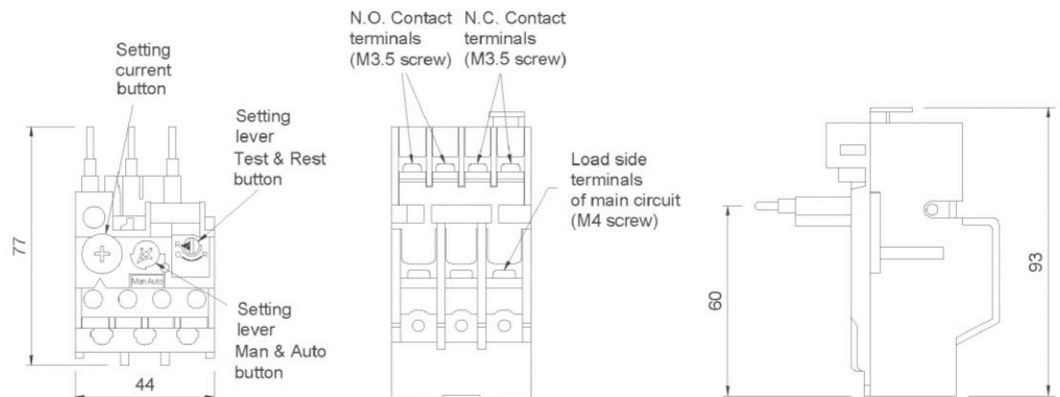
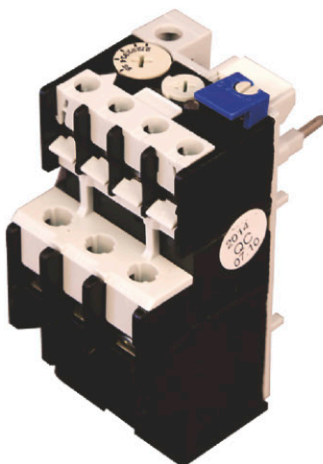

DETH SERIES 50 - DETH 126 SERIES

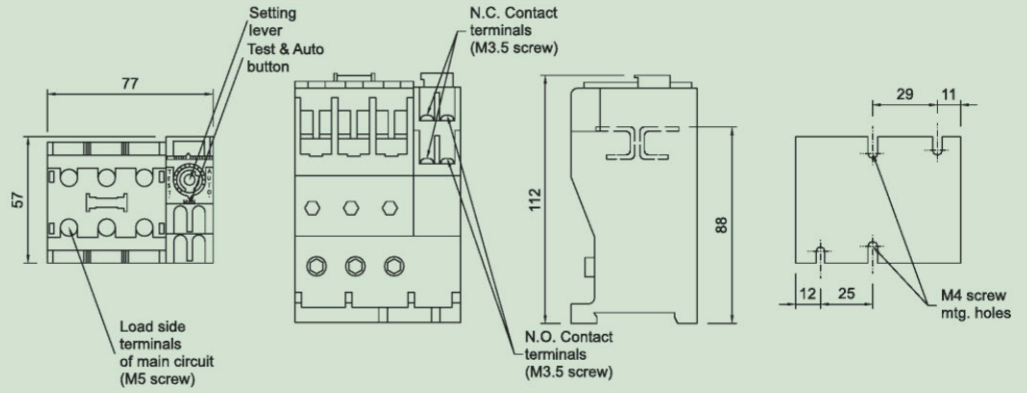

IMPORTANT RANGE SETTING AND APPLICATION INFORMATION

Test Position

Turn the arrow of red reset button to Test position. When pressing the red reset button, contact N/C would be opened, contact N/O would be closed.

Manual Position

Turn the arrow of red reset button to MAN position. When Overload Relay is not

tripped state, the red reset button function is stop button. When pressing red reset button, contact N/C would be opened and contact N/O would be still opened. When Overload Relay is tripped state, contact N/C would be opened and contact N/O would be closed, now the red reset button function is reset.

When pressing red reset button, contact N/C and N/O would be returned the original condition.

Auto Position

To press red button, then it could be rotated the arrow to Auto position. As Overload Relay is not tripped state, the red reset button could be

stop button. When pressing red reset button, contact N/C would be opened and contact N/O would be still opened. When Overload Relay is tripped state, contact N/C would be opened and contact N/O would be closed, the tripped relay will automatically reset itself after approx. 1 min.

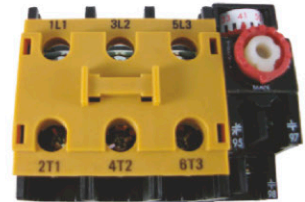

ACCESSORIES

ADAPTER PLATE DETAILS,
DEC-45D-02C FOR
3MM DIN RAIL MOUNTING OF
DEC-45D/55D/65D/80D/100D

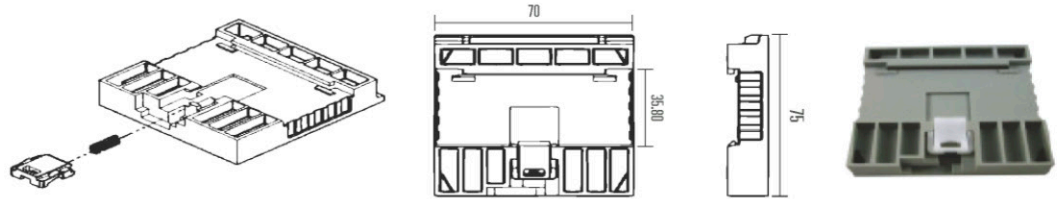

SEPARATE MOUNTING BLOCK
DETH-04 FOR DETH SERIES
THERMAL OVERLOAD RELAYS

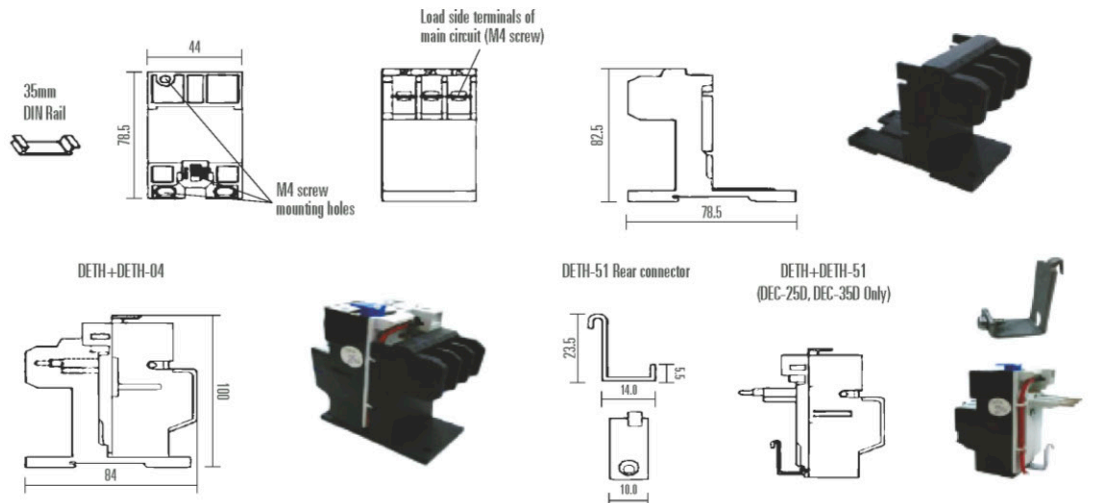

AUXILIARY CONTACT & MECHANICAL INTERLOCK MODULE

The contact blocks are generally rated lower than the main contactor and are used for lower power switching or control/indication functions.

For applications where contactors are used in pairs (e.g. motor starters, voltage change over units) the mechanical interlock modules are used to prevent

both contactors turning on together in the event of a control system failure or one contactor welding shut due to an electrical short circuit. The module mechanically

connects 2 contactors (of the same size) and with the interlock fitted if one contactor is already on, the second contactor cannot switch on even if the control coil is powered.

AUXILIARY CONTACT & MECHANICAL INTERLOCK MODULE - DECA SERIES

Product Code	Description	Auxiliary N/O	Auxiliary N/C	Insulation Voltage	Thermal Current	Weight (kg)
DECA1-D20	Top mounting aux. contact 2x N/O	2	-	660V	10A	0.033
DECA1-D11	Top mounting aux. contact 1x N/O	1	1	660V	10A	0.033
DECA1-D02	Top mounting aux. contact 1x N/O+1x N/C	-	2	660V	10A	0.033
DECA1-D40	Top mounting aux. contact 4x N/O	4	-	660V	10A	0.059
DECA1-D31	Top mounting aux. contact 3x N/O+1x N/C	3	1	660V	10A	0.059
DECA1-D22	Top mounting aux. contact 2x N/O+2x N/C	2	2	660V	10A	0.059
DECA1-D13	Top mounting aux. contact 1x N/O+3x N/C	1	3	660V	10A	0.059
DECA1-D04	Top mounting aux. contact 4x N/C	-	4	660V	10A	0.059
DECA8-D20	Side mounting aux. contact 2x N/O	2	-	660V	10A	0.035
DECA8-D11	Side mounting aux. contact 1x N/O + 1x N/C	1	1	660V	10A	0.035
DECA8-D02	Side mounting aux. contact 2x N/C	-	2	660V	10A	0.035
DECA9-D02	Side mounting mechanical interlock with 2x N/C contacts	-	2	660V	10A	0.035



DECA1 SERIES (2P)

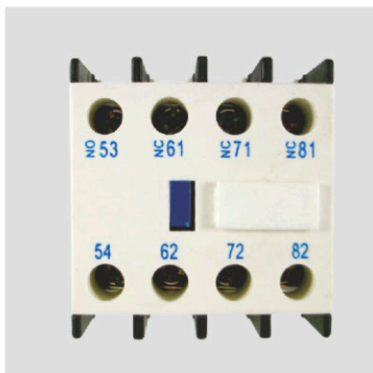
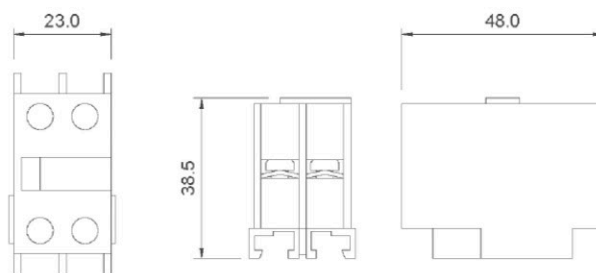

DECA1 SERIES (4P)

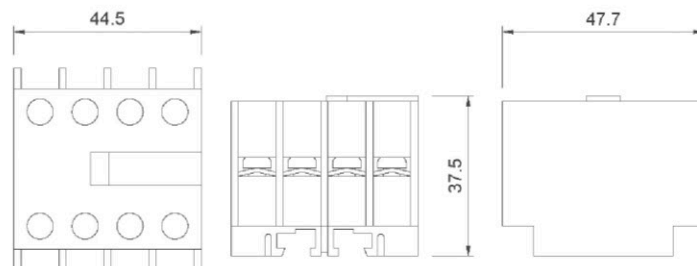

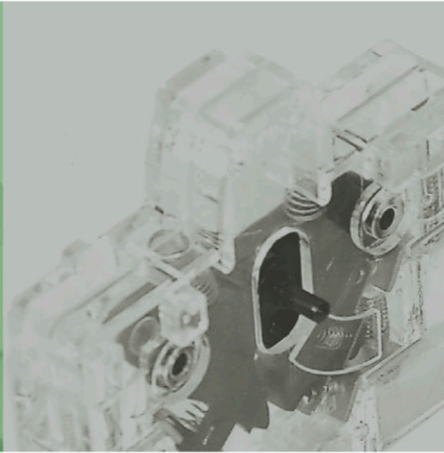
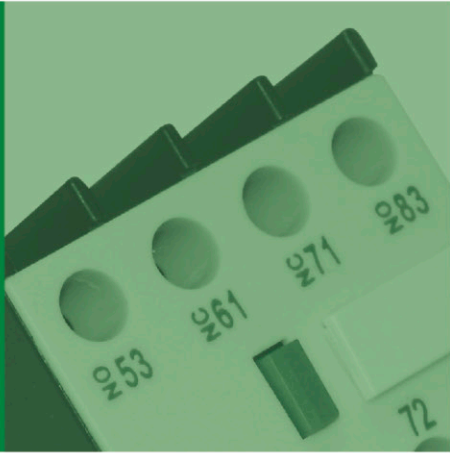

Features:

- Rated 10A max at 600VAC, U_i:600V, I_{th}:10A.
- All products are suitable for use with contactors DEC11D to DEC100D.

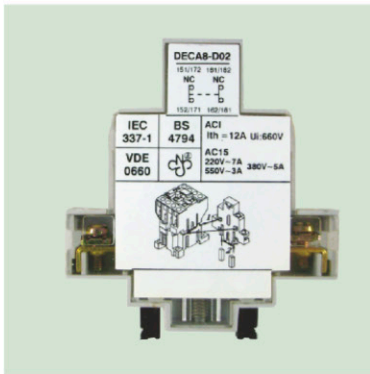

DECA8 SERIES (2P)

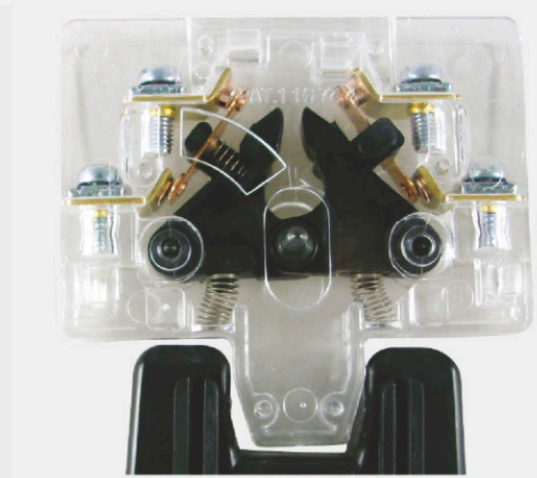
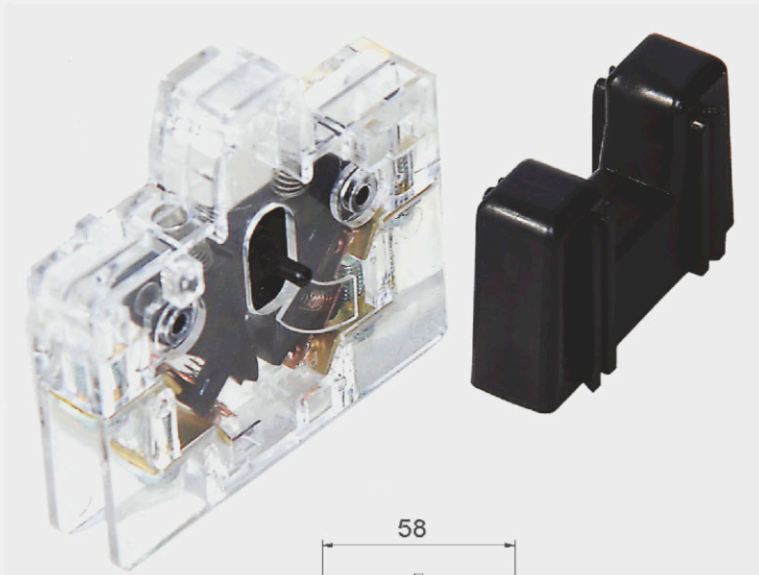
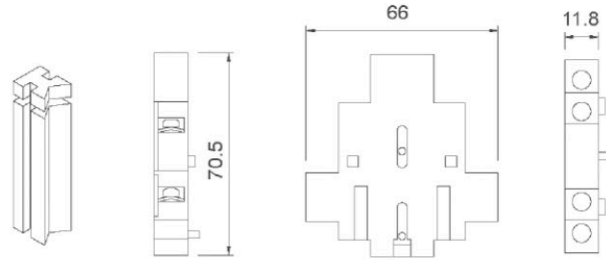

DECA9 SERIES

Patented
Patent No. 282153

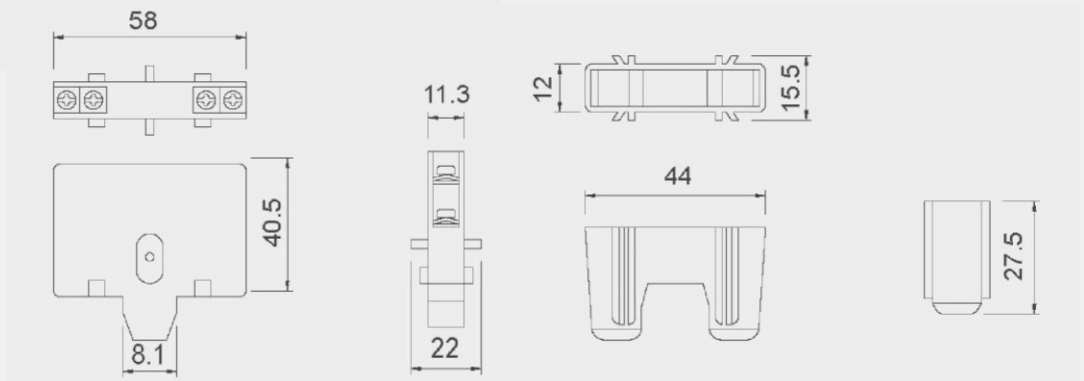

TOP MOUNTING ENCLOSURE & FILTER FANS



TOP MOUNTING ENCLOSURE FANS

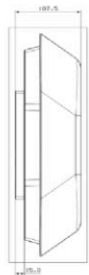

FILTER FANS

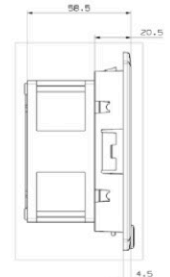
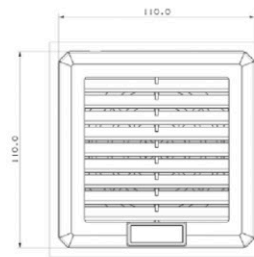

These images are representative only.

TOP MOUNTING ENCLOSURE FANS

Product Code	Air Flow Rate (m ³ /h)	Power Supply (V/Hz)	H (mm)	W (mm)	L (mm)	Power Consumption (W)	Current Consumption (A)	Over Current Protection	Electrical Connection
DEFF 5500	560	230V 50-60Hz	364.4	364.4	107.5	58/75	0.26/0.34	Thermal	4-pole terminal 2.5mm ²
DEFF 6000	970	230V 50-60Hz	364.4	364.4	107.5	85/90	0.38/0.44	Thermal	4-pole terminal 2.5mm ²

FILTER FANS - 30M³/H

Product Code	Air Flow Rate (m ³ /h)	Power Supply (V/Hz)	H (mm)	W (mm)	L (mm)	Power Consumption (W)	Current Consumption (A)	Over Current Protection	Electrical Connection
DEFI 1000			110	110	20.5				
DETF 1000	30 (41)	230V 50-60Hz	110	110	58.5	14 (13)	0.08/0.07	Impedance	Lead wire

FILTER FANS - 100M³/H

Product Code	Air Flow Rate (m ³ /h)	Power Supply (V/Hz)	H (mm)	W (mm)	L (mm)	Power Consumption (W)	Current Consumption (A)	Over Current Protection	Electrical Connection
DEFI 1500			160	160	31				
DETF 1500	100 (140)	230V 50-60Hz	160	160	69	26 (23)	0.14/0.13	Impedance	Lead wire

FILTER FANS - 115M³/H

Product Code	Air Flow Rate (m ³ /h)	Power Supply (V/Hz)	H (mm)	W (mm)	L (mm)	Power Consumption (W)	Current Consumption (A)	Over Current Protection	Electrical Connection
DEFI 2500			260	260	31				
DETF 2500	115 (130)	230V 50-60Hz	260	260	103	26 (23)	0.14/0.13	Impedance	3-pole terminal

FILTER FANS - 240M³/H

Product Code	Air Flow Rate (m ³ /h)	Power Supply (V/Hz)	H (mm)	W (mm)	L (mm)	Power Consumption (W)	Current Consumption (A)	Over Current Protection	Electrical Connection
DEFI 2500			260	260	31				
DETF 3500	240 (270)	230V 50-60Hz	260	260	116	37 (35)	0.23/0.22	Impedance	3-pole terminal

FILTER FANS - 650M³/H

Product Code	Air Flow Rate (m ³ /h)	Power Supply (V/Hz)	H (mm)	W (mm)	L (mm)	Power Consumption (W)	Current Consumption (A)	Over Current Protection	Electrical Connection
DEFI 2500			260	260	31				
DETF 4500	650 (900)	230V 50-60Hz	260	260	111	66 (75)	0.35/0.38	Thermal	4-pole terminal

FILTER FANS - 850M³/H

Product Code	Air Flow Rate (m ³ /h)	Power Supply (V/Hz)	H (mm)	W (mm)	L (mm)	Power Consumption (W)	Current Consumption (A)	Over Current Protection	Electrical Connection
DEFI 3000			325	325	31				
DETF 5000	850 (1200)	230V 50-60Hz	325	325	111	110 (140)	0.50/0.72	Thermal	4-pole terminal

Features:

- Filter fans with air flow from 30m³/hr to 850m³/hr.
- Filter mats, filter housings and protection grills available for fan products.
- Outside-in or inside-out flow direction, depending on model.
- Up to IP54 protection available depending on unit.

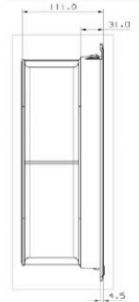
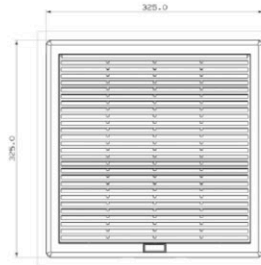

Please see table for details.

	Operating Temperature (°C)	Protection Degree	Noise Level (dB(A))	Flow Direction	Bearing	Service Life (Hr)	Plastic Material	Gasket	Weight (kg)	Mounting
	-10°C to +70°C	IP44	62 (64)	Inside-out	Ball	50.000	UL94 V0 ABS Flame Retardant	Polyurethane sealing	3.16	8 pcs m4 screws
	-10°C to +70°C	IP44	72 (73)	Inside-out	Ball	50.000	UL94 V0 ABS Flame Retardant	Polyurethane sealing	3.74	8 pcs m4 screws

	Operating Temperature (°C)	Protection Degree	Noise Level (dB(A))	Flow Direction	Bearing	Colour	Plastic Material	Gasket	Weight (kg)	Mounting
	-10°C to +70°C	IP54				RAL 7035 (RAL 7032 on request)	UL94 V0 ABS Flame Retardant	Self-Adhesive	0.10	Fast Clip-on
	-10°C to +70°C	IP54/Class 1	28 (31)	Outside-In	Sleeve	RAL 7035 (RAL 7032 on request)	UL94 V0 ABS Flame Retardant	Self-Adhesive	0.40	Fast Clip-on

	-10°C to +70°C	IP54				RAL 7035 (RAL 7032 on request)	UL94 V0 ABS Flame Retardant	Polyurethane sealing	0.18	Fast Clip-on
	-10°C to +70°C	IP54/Class 1	42 (46)	Outside-In	Ball	RAL 7035 (RAL 7032 on request)	UL94 V0 ABS Flame Retardant	Polyurethane sealing	0.68	Fast Clip-on

	-10°C to +70°C	IP54				RAL 7035 (RAL 7032 on request)	UL94 V0 ABS Flame Retardant	Polyurethane sealing	0.48	Fast Clip-on
	-10°C to +70°C	IP54/Class 1	42 (46)	Outside-In	Ball	RAL 7035 (RAL 7032 on request)	UL94 V0 ABS Flame Retardant	Polyurethane sealing	1.18	Fast Clip-on

	-10°C to +70°C	IP54				RAL 7035 (RAL 7032 on request)	UL94 V0 ABS Flame Retardant	Polyurethane sealing	0.48	Fast Clip-on
	-10°C to +70°C	IP54/Class 1	52 (53)	Outside-In	Ball	RAL 7035 (RAL 7032 on request)	UL94 V0 ABS Flame Retardant	Polyurethane sealing	1.60	Fast Clip-on

	-10°C to +70°C	IP54				RAL 7035 (RAL 7032 on request)	UL94 V0 ABS Flame Retardant	Polyurethane sealing	0.48	Fast Clip-on
	-10°C to +70°C	IP54/Class 1	60 (63)	Outside-In	Ball	RAL 7035 (RAL 7032 on request)	UL94 V0 ABS Flame Retardant	Polyurethane sealing	2.84	Fast Clip-on

	-10°C to +70°C	IP54				RAL 7035 (RAL 7032 on request)	UL94 V0 ABS Flame Retardant	Polyurethane sealing	0.70	Fast Clip-on
	-10°C to +70°C	IP54/Class 1	65 (68)	Outside-In	Ball	RAL 7035 (RAL 7032 on request)	UL94 V0 ABS Flame Retardant	Polyurethane sealing	4.12	Fast Clip-on

CONTROL EQUIPMENT



DUAL THERMOSTAT

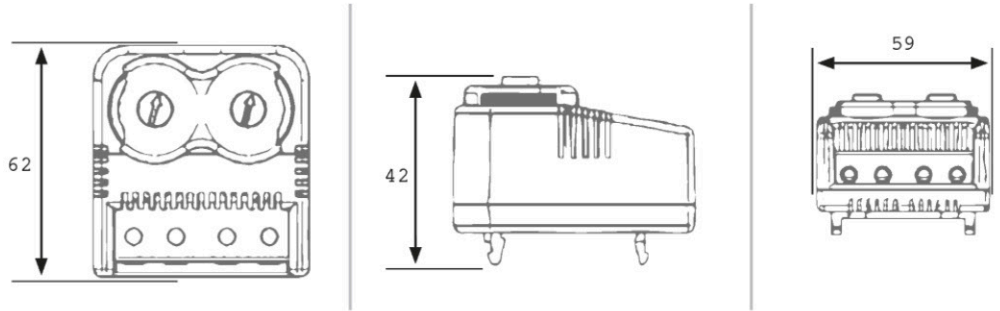

THERMOSTATS

Product Code	Contact Function	Temperature Setting Range (°C)	Colour of Potentiometer	Maximum 250V AC/120V AC (A)	Sensor Type	Contact Type	Service Life (Cycles)	Electrical Connection	Plastic Material
DEHT	N/C	0°C to 60°C	Red	10 (2)	Bimetal	Snap action	>100.000	2-pole terminal	UL94 V0 ABS Flame Retardant
DEVT	N/O	0°C to 60°C	Blue	15 (2)	Bimetal	Snap action	>100.000	2-pole terminal	UL94 V0 ABS Flame Retardant

DOUBLE THERMOSTAT

DEHVT	N/C+N/O	0°C to 60°C/ 0°C to 60°C	Red+Blue	10 (2) / 15 (2)	Bimetal	Snap Action	>100.000	4 - Pole Terminal	UL94 V0 ABS Flame Retardant
-------	---------	-----------------------------	----------	-----------------	---------	-------------	----------	-------------------	--------------------------------

MECHANICAL HYGROSTAT

Product Code	Power Supply (V AC)	Setting Range (%RH)	Colour of Potentiometer	Current (A)	Differential	Sensor type	Electrical Connections	Electrical section wires
DEHG02	110 - 250	10 - 90	Black	10 - 5	%5, max, %10	Polyamide ribbon	3-pole terminal	From 0.75mm ² to 4.0mm ²

TYPICAL CONNECTION DIAGRAMS

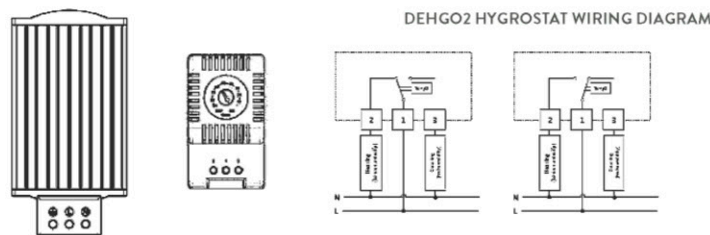
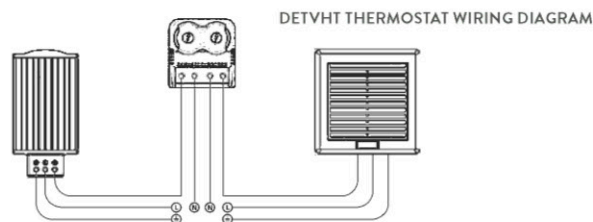

Features:

- Single N/O & N/C thermostats, (range 0°C to 60°C).
- Dual N/O+N/C thermostat, (range 0°C to 60°C).
- Mechanical hygrostat with setting range 10-90%RH.



THERMOSTAT



HYGROSTAT

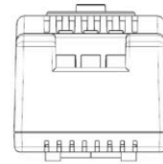
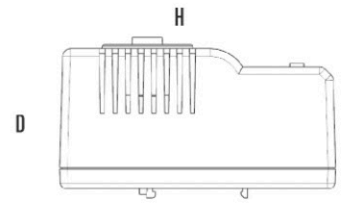
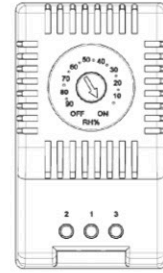

W

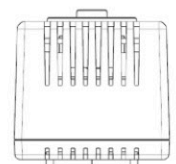

Protection Degree (EN60529)	Operating Temperature (°C)	Storage Temperature (°C)	Mounting	Installation Position	Dimensions H x W x D	Weight (g)
IP20	-25°C to +80°C	-45°C to +80°C	Clip for mounting on DIN rail 35mm	Variable	61x34x38	45
IP20	-25°C to +80°C	-45°C to +80°C	Clip for mounting on DIN rail 35mm	Variable	61x34x38	45

IP20	-25°C to +80°C	-45°C to +80°C	Clip for mounting on DIN rail 35mm	Variable	65x59x42	80
------	----------------	----------------	------------------------------------	----------	----------	----

Operating Temperature (°C)	Storage Temperature (°C)	Protection Degree	Colour	Mounting	Dimensions H x W x D	Weight (g)
+10°C to +60°C	+10°C to +60°C	IP20	RAL 7035	Clip for mounting on DIN rail 35mm	105x60x55	180

DETVT THERMOSTAT WIRING DIAGRAM

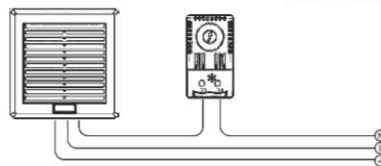

DETHT THERMOSTAT WIRING DIAGRAM

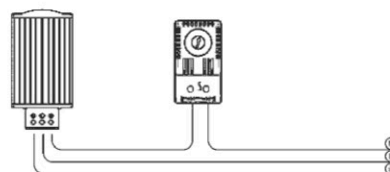

PANEL HEATERS



PTC PANEL HEATERS

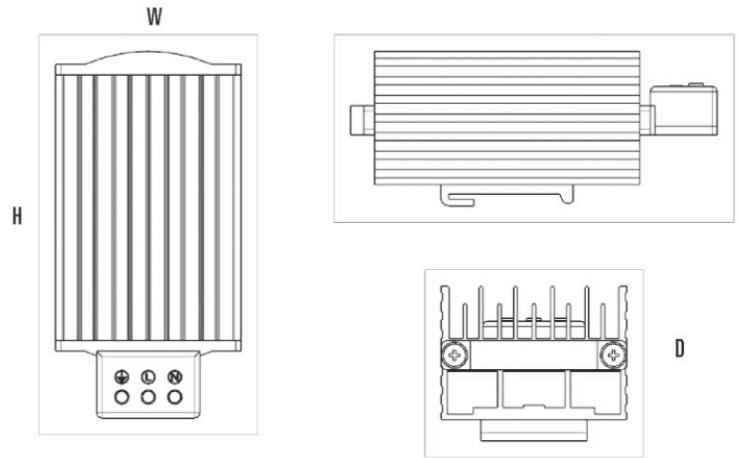

PTC PANEL HEATERS

Product Code	Heating Capacity (W)	Power Supply (V)	Max Current (A)	Heating Element Type	Overcurrent Protection	Electrical Connections	Protection Class IEC	Protection Degree EN60529	Operating Temperature (°C)
DEHT 030	30	110-250V AC/DC	2A	PTC resistor, self regulating	Electronic thermal overload	3-pole terminal N-L-E	Class II	IP20	-45°C to +70°C
DEHT 050	50		2A					IP20	-45°C to +70°C
DEHT 075	75		4A					IP20	-45°C to +70°C
DEHT 100	100		4A					IP20	-45°C to +70°C
DEHT 150	150		6A					IP20	-45°C to +70°C

PANEL HEATERS WITH FAN

Product Code	Heating Capacity (W)	Power Supply (V)	Max Current (A)	Heating Element Type	Axial Fan	Overcurrent Protection	Electrical Connections	Protection Class IEC	Protection Degree EN60529
DEFHT 250	250	230V 50/60 Hz	1.2A	Resistor Heater	80x80x25mm 35m³/h	Electronic thermal overload	3-pole terminal N-L-E	Class I, earthed	IP2
DEFHT 500	500		2.4A						IP2
DEFHT 750	750		3.6A						IP2

ACCESSORIES

Product Code	Description	Pack in Pcs
DEFM1000	Filter mat for PFI1000	10
DEFM1500	Filter mat for PFI1500	10
DEFM2500	Filter mat for PFI2500	10
DEFM3000	Filter mat for PFI3000	10



Features:

- Process heaters available with and without integral fans.
- PTC resistor heating elements.
- Electronic thermal overload protection.
- Filter fans and protection grill accessories available.



PANEL HEATERS WITH FAN

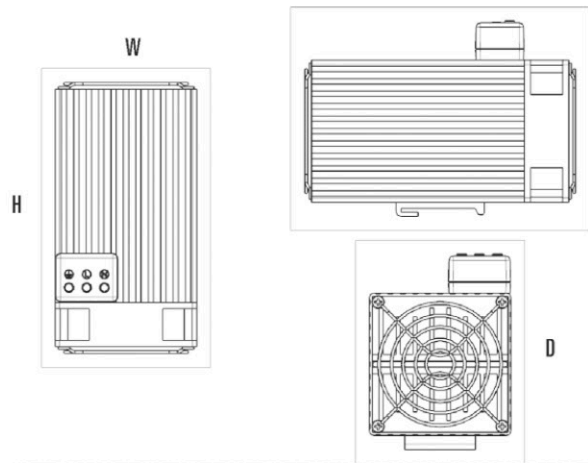

	Storage Temperature (°C)	Radiator	Mounting	Installation Position	Dimensions H x W x D	Weight (kg)
	-45°C to +70°C	Aluminium profile, anodized	Clip for mounting on DIN rail 35mm	Best efficiency in vertical position	128x70x59	0.41
	-45°C to +70°C				138x70x59	0.44
	-45°C to +70°C				178x70 x59	0.54
	-45°C to +70°C				188x70x59	0.59
	-45°C to +70°C				228x70x59	0.72

	Operating Temperature (°C)	Storage Temperature (°C)	Radiator	Mounting	Installation Position	Dimensions H x W x D	Weight (kg)
	-25°C to +70°C	-25°C to +70°C	Aluminium profile, anodized	Clip for mounting on DIN rail 35mm	Best efficiency in vertical position	158x80x110	0.98
	-25°C to +70°C	-25°C to +70°C				182x80x110	1.20
	-25°C to +70°C	-25°C to +70°C				232x80x110	1.45

ACCESSORIES

Product Code	Description	Pack in Pcs
DET0808	Metallic protection grill for 80x80mm	100
DET1212	Metallic protection grill for 120x120mm	100
DET1717	Metallic protection grill for 170x170mm	100
DET2020	Metallic protection grill for 225x225mm	100
DET2525	Metallic protection grill for 280x280mm	100

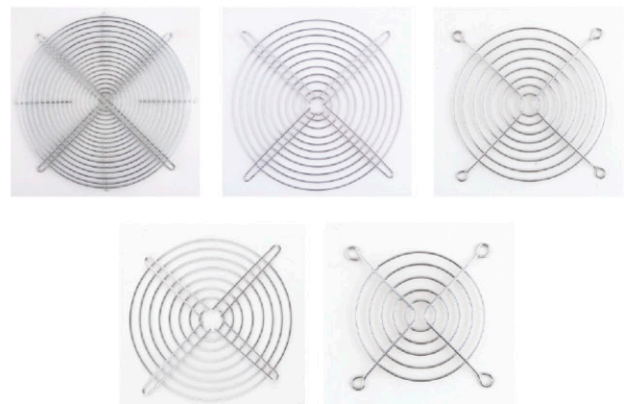

PCB TERMINAL BLOCKS THROUGH HOLE MOUNTING / WIRE PROTECTED

TL001R-xxPKC

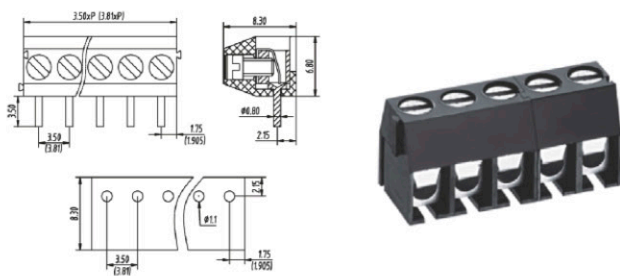

2-24 Pole Screw Wire Protector Wave - through hole. Horizontal 3.5mm pitch

		N° of Poles	Pole Length (mm)	Product Code	N° of Poles	Pole Length (mm)	Product Code
Pitch (mm)	3.5	2	7	TL001R-02PKC	14	49	TL001R-14PKC
Wire Size AWG	Min: 24 / Max: 16	3	10.5	TL001R-03PKC	15	52.5	TL001R-15PKC
Wire Size (mm²)	Min: 0.2 / Max: 1.5	4	14	TL001R-04PKC	16	56	TL001R-16PKC
PCB Hole Ø	1.1	5	17.5	TL001R-05PKC	17	59.5	TL001R-17PKC
Orientation	Horizontal	6	21	TL001R-06PKC	18	63	TL001R-18PKC
Mount Type	Wave - Through Hole	7	24.5	TL001R-07PKC	19	66.5	TL001R-19PKC
Screw	Cross Head	8	28	TL001R-08PKC	20	70	TL001R-20PKC
Join	Interlocking	9	31.5	TL001R-09PKC	21	73.5	TL001R-21PKC
Colour	Green or Black	10	35	TL001R-10PKC	22	77	TL001R-22PKC
Current	6A (UL)	11	38.5	TL001R-11PKC	23	80.5	TL001R-23PKC
Voltage	300V (UL)	12	42	TL001R-12PKC	24	84	TL001R-24PKC
Approval Bodies		13	45.5	TL001R-13PKC			

TL001V-xxPKC

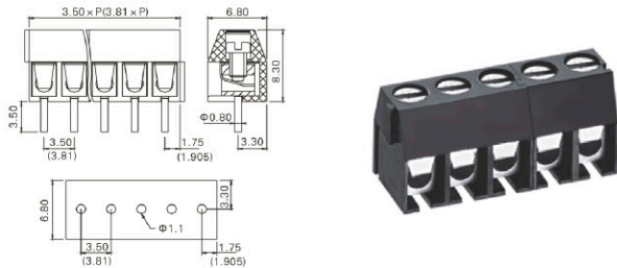

2-24 Pole Screw Wire Protector Wave - through hole. Vertical 3.5mm pitch

		N° of Poles	Pole Length (mm)	Product Code	N° of Poles	Pole Length (mm)	Product Code
Pitch (mm)	3.5	2	7	TL001V-02PKC	14	49	TL001V-14PKC
Wire Size AWG	Min: 24 / Max: 16	3	10.5	TL001V-03PKC	15	52.5	TL001V-15PKC
Wire Size (mm²)	Min: 0.2 / Max: 1.5	4	14	TL001V-04PKC	16	56	TL001V-16PKC
PCB Hole Ø	1.1	5	17.5	TL001V-05PKC	17	59.5	TL001V-17PKC
Orientation	Vertical	6	21	TL001V-06PKC	18	63	TL001V-18PKC
Mount Type	Wave - Through Hole	7	24.5	TL001V-07PKC	19	66.5	TL001V-19PKC
Screw	Cross Head	8	28	TL001V-08PKC	20	70	TL001V-20PKC
Join	Interlocking	9	31.5	TL001V-09PKC	21	73.5	TL001V-21PKC
Colour	Green or Black	10	35	TL001V-10PKC	22	77	TL001V-22PKC
Current	6A (UL)	11	38.5	TL001V-11PKC	23	80.5	TL001V-23PKC
Voltage	300V (UL)	12	42	TL001V-12PKC	24	84	TL001V-24PKC
Approval Bodies		13	45.5	TL001V-13PKC			

TL100R-xxPKC

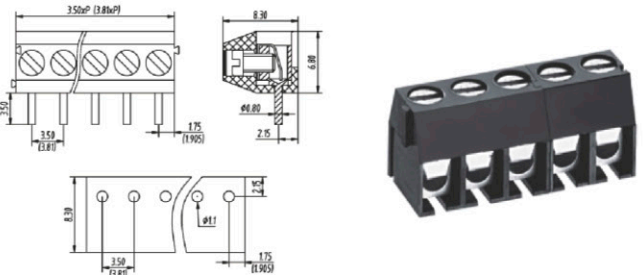

2-24 Pole Screw Wire Protector Wave - through hole Horizontal 3.81mm pitch

		N° of Poles	Pole Length (mm)	Product Code	N° of Poles	Pole Length (mm)	Product Code
Pitch (mm)	3.81	2	7.62	TL100R-02PKC	14	53.34	TL100R-14PKC
Wire Size AWG	Min: 24 / Max: 16	3	11.43	TL100R-03PKC	15	57.15	TL100R-15PKC
Wire Size (mm²)	Min: 0.2 / Max: 1.5	4	15.24	TL100R-04PKC	16	60.96	TL100R-16PKC
PCB Hole Ø	1.1	5	19.05	TL100R-05PKC	17	64.77	TL100R-17PKC
Orientation	Horizontal	6	22.86	TL100R-06PKC	18	68.58	TL100R-18PKC
Mount Type	Wave - Through Hole	7	26.67	TL100R-07PKC	19	72.39	TL100R-19PKC
Screw	Cross Head	8	30.48	TL100R-08PKC	20	76.2	TL100R-20PKC
Join	Interlocking	9	34.29	TL100R-09PKC	21	80.01	TL100R-21PKC
Colour	Green or Black	10	38.1	TL100R-10PKC	22	83.82	TL100R-22PKC
Current	6A (UL)	11	41.91	TL100R-11PKC	23	87.63	TL100R-23PKC
Voltage	300V (UL)	12	45.72	TL100R-12PKC	24	91.44	TL100R-24PKC
Approval Bodies		13	49.53	TL100R-13PKC			

Features:

- Relevant approvals in place or applied for
- All standard pitch configurations available
- All PCB Mounting Connectors are through board suitable for wave soldering
- Most items are available in 2-24 poles
- Standard colour options include Green or Black

TL100V-xxPKC

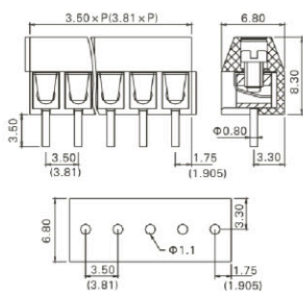

2-24 Pole Screw Wire Protector Wave - through hole Vertical 3.81mm pitch

		N° of Poles	Pole Length (mm)	Product Code	N° of Poles	Pole Length (mm)	Product Code
Pitch (mm)	3.81	2	7.62	TL100V-02PKC	14	53.34	TL100V-14PKC
Wire Size AWG	Min: 24 / Max: 16	3	11.43	TL100V-03PKC	15	57.15	TL100V-15PKC
Wire Size (mm ²)	Min: 0.2 / Max: 1.5	4	15.24	TL100V-04PKC	16	60.96	TL100V-16PKC
PCB Hole Ø	1.1	5	19.05	TL100V-05PKC	17	64.77	TL100V-17PKC
Orientation	Vertical	6	22.86	TL100V-06PKC	18	68.58	TL100V-18PKC
Mount Type	Wave - Through Hole	7	26.67	TL100V-07PKC	19	72.39	TL100V-19PKC
Screw	Cross Head	8	30.48	TL100V-08PKC	20	76.2	TL100V-20PKC
Join	Interlocking	9	34.29	TL100V-09PKC	21	80.01	TL100V-21PKC
Colour	Green or Black	10	38.1	TL100V-10PKC	22	83.82	TL100V-22PKC
Current	6A (UL)	11	41.91	TL100V-11PKC	23	87.63	TL100V-23PKC
Voltage	300V (UL)	12	45.72	TL100V-12PKC	24	91.44	TL100V-24PKC
Approval Bodies		13	49.53	TL100V-13PKC			

TL200R-xxPKC

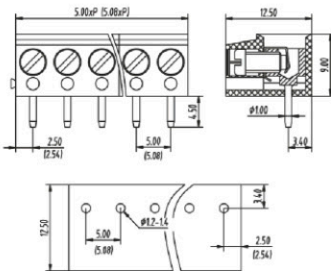

2-24 Pole Screw Wire Protector Wave - through hole Horizontal 5mm pitch

		N° of Poles	Pole Length (mm)	Product Code	N° of Poles	Pole Length (mm)	Product Code
Pitch (mm)	5	2	10	TL200R-02PKC	14	70	TL200R-14PKC
Wire Size AWG	Min: 22 / Max: 14	3	15	TL200R-03PKC	15	75	TL200R-15PKC
Wire Size (mm ²)	Min: 0.5 / Max: 2.5	4	20	TL200R-04PKC	16	80	TL200R-16PKC
PCB Hole Ø	1.2-1.4	5	25	TL200R-05PKC	17	85	TL200R-17PKC
Orientation	Horizontal	6	30	TL200R-06PKC	18	90	TL200R-18PKC
Mount Type	Wave - Through Hole	7	35	TL200R-07PKC	19	95	TL200R-19PKC
Screw	Cross Head	8	40	TL200R-08PKC	20	100	TL200R-20PKC
Join	Interlocking	9	45	TL200R-09PKC	21	105	TL200R-21PKC
Colour	Green or Black	10	50	TL200R-10PKC	22	110	TL200R-22PKC
Current	16A (UL) / 24A (VDE)	11	55	TL200R-11PKC	23	115	TL200R-23PKC
Voltage	300V (UL) / 250V (VDE)	12	60	TL200R-12PKC	24	120	TL200R-24PKC
Approval Bodies		13	65	TL200R-13PKC			

TL201R-xxPKC

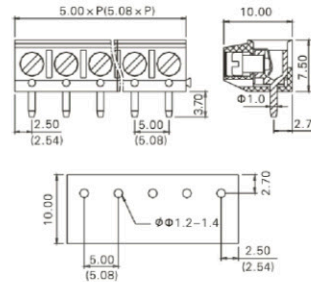

2-24 Pole Screw Wire Protector Wave - through hole Horizontal 5mm pitch

		N° of Poles	Pole Length (mm)	Product Code	N° of Poles	Pole Length (mm)	Product Code
Pitch (mm)	5	2	10	TL201R-02PKC	14	70	TL201R-14PKC
Wire Size AWG	Min: 20 / Max: 14	3	15	TL201R-03PKC	15	75	TL201R-15PKC
Wire Size (mm ²)	Min: 0.34 / Max: 2.5	4	20	TL201R-04PKC	16	80	TL201R-16PKC
PCB Hole Ø	1.2-1.4	5	25	TL201R-05PKC	17	85	TL201R-17PKC
Orientation	Horizontal	6	30	TL201R-06PKC	18	90	TL201R-18PKC
Mount Type	Wave - Through Hole	7	35	TL201R-07PKC	19	95	TL201R-19PKC
Screw	Cross Head	8	40	TL201R-08PKC	20	100	TL201R-20PKC
Join	Interlocking	9	45	TL201R-09PKC	21	105	TL201R-21PKC
Colour	Green or Black	10	50	TL201R-10PKC	22	110	TL201R-22PKC
Current	16A (UL) / 16A (VDE)	11	55	TL201R-11PKC	23	115	TL201R-23PKC
Voltage	300V (UL) / 130V (VDE)	12	60	TL201R-12PKC	24	120	TL201R-24PKC
Approval Bodies		13	65	TL201R-13PKC			

*xx = number of poles

PCB TERMINAL BLOCKS THROUGH HOLE MOUNTING / WIRE PROTECTED

TL200V-xxPKC

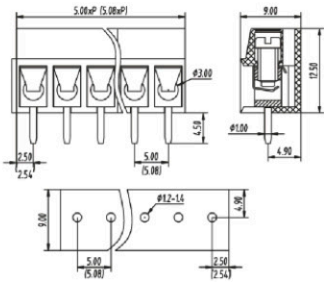

2-24 Pole Screw Wire Protector Wave -
through hole Vertical 5mm pitch

		N° of Poles	Pole Length (mm)	Product Code	N° of Poles	Pole Length (mm)	Product Code
Pitch (mm)	5	2	10	TL200V-02PKC	14	70	TL200V-14PKC
Wire Size AWG	Min: 22 / Max: 14	3	15	TL200V-03PKC	15	75	TL200V-15PKC
Wire Size (mm ²)	Min: 0.5 / Max: 2.5	4	20	TL200V-04PKC	16	80	TL200V-16PKC
PCB Hole Ø	1.2-1.4	5	25	TL200V-05PKC	17	85	TL200V-17PKC
Orientation	Vertical	6	30	TL200V-06PKC	18	90	TL200V-18PKC
Mount Type	Wave - Through Hole	7	35	TL200V-07PKC	19	95	TL200V-19PKC
Screw	Cross Head	8	40	TL200V-08PKC	20	100	TL200V-20PKC
Join	Interlocking	9	45	TL200V-09PKC	21	105	TL200V-21PKC
Colour	Green or Black	10	50	TL200V-10PKC	22	110	TL200V-22PKC
Current	16A (UL) / 24A (VDE)	11	55	TL200V-11PKC	23	115	TL200V-23PKC
Voltage	300V (UL) / 250V (VDE)	12	60	TL200V-12PKC	24	120	TL200V-24PKC
Approval Bodies		13	65	TL200V-13PKC			

TL201V-xxPKC

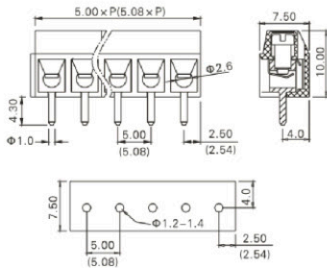

2-24 Pole Screw Wire Protector Wave -
through hole Vertical 5mm pitch

		N° of Poles	Pole Length (mm)	Product Code	N° of Poles	Pole Length (mm)	Product Code
Pitch (mm)	5	2	10	TL201V-02PKC	14	70	TL201V-14PKC
Wire Size AWG	Min: 20 / Max: 14	3	15	TL201V-03PKC	15	75	TL201V-15PKC
Wire Size (mm ²)	Min: 0.34 / Max: 2.5	4	20	TL201V-04PKC	16	80	TL201V-16PKC
PCB Hole Ø	1.2-1.4	5	25	TL201V-05PKC	17	85	TL201V-17PKC
Orientation	Vertical	6	30	TL201V-06PKC	18	90	TL201V-18PKC
Mount Type	Wave - Through Hole	7	35	TL201V-07PKC	19	95	TL201V-19PKC
Screw	Cross Head	8	40	TL201V-08PKC	20	100	TL201V-20PKC
Join	Interlocking	9	45	TL201V-09PKC	21	105	TL201V-21PKC
Colour	Green or Black	10	50	TL201V-10PKC	22	110	TL201V-22PKC
Current	16A (UL) / 16A (VDE)	11	55	TL201V-11PKC	23	115	TL201V-23PKC
Voltage	300V (UL) / 130V (VDE)	12	60	TL201V-12PKC	24	120	TL201V-24PKC
Approval Bodies		13	65	TL201V-13PKC			

TL201V-xxPKC-S

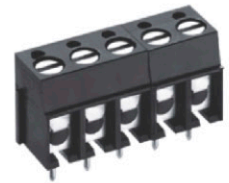
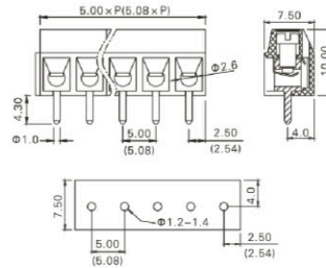

2-24 Pole Screw Wire Protector Wave -
through hole Vertical 5mm pitch

		N° of Poles	Pole Length (mm)	Product Code	N° of Poles	Pole Length (mm)	Product Code
Pitch (mm)	5	2	10	TL201V-02PKC-S	14	70	TL201V-14PKC-S
Wire Size AWG	Min: 20 / Max: 14	3	15	TL201V-03PKC-S	15	75	TL201V-15PKC-S
Wire Size (mm ²)	Min: 0.34 / Max: 2.5	4	20	TL201V-04PKC-S	16	80	TL201V-16PKC-S
PCB Hole Ø	1.2-1.4	5	25	TL201V-05PKC-S	17	85	TL201V-17PKC-S
Orientation	Vertical	6	30	TL201V-06PKC-S	18	90	TL201V-18PKC-S
Mount Type	Wave - Through Hole	7	35	TL201V-07PKC-S	19	95	TL201V-19PKC-S
Screw	Slot Screw	8	40	TL201V-08PKC-S	20	100	TL201V-20PKC-S
Join	Interlocking	9	45	TL201V-09PKC-S	21	105	TL201V-21PKC-S
Colour	Green or Black	10	50	TL201V-10PKC-S	22	110	TL201V-22PKC-S
Current	16A (UL) / 16A (VDE)	11	55	TL201V-11PKC-S	23	115	TL201V-23PKC-S
Voltage	300V (UL) / 130V (VDE)	12	60	TL201V-12PKC-S	24	120	TL201V-24PKC-S
Approval Bodies		13	65	TL201V-13PKC-S			

Features:

- Relevant approvals in place or applied for
- All standard pitch configurations available
- All PCB Mounting Connectors are through board suitable for wave soldering
- Most items are available in 2-24 poles
- Standard colour options include Green or Black

TL202V-xxPKC

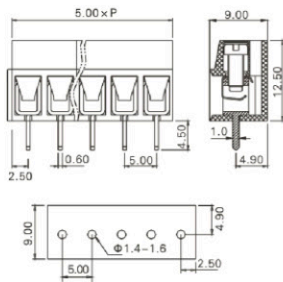

2-24 Pole Screw Wire Protector Wave - through hole Vertical 5mm pitch

		N° of Poles	Pole Length (mm)	Product Code	N° of Poles	Pole Length (mm)	Product Code
Pitch (mm)	5	2	10	TL202V-02PKC	14	70	TL202V-14PKC
Wire Size AWG	Min: 22 / Max: 12	3	15	TL202V-03PKC	15	75	TL202V-15PKC
Wire Size (mm ²)	Min: 0.34 / Max: 4	4	20	TL202V-04PKC	16	80	TL202V-16PKC
PCB Hole Ø	1.4-1.6	5	25	TL202V-05PKC	17	85	TL202V-17PKC
Orientation	Vertical	6	30	TL202V-06PKC	18	90	TL202V-18PKC
Mount Type	Wave - Through Hole	7	35	TL202V-07PKC	19	95	TL202V-19PKC
Screw	Cross Head	8	40	TL202V-08PKC	20	100	TL202V-20PKC
Join	Interlocking	9	45	TL202V-09PKC	21	105	TL202V-21PKC
Colour	Green or Black	10	50	TL202V-10PKC	22	110	TL202V-22PKC
Current	16A (UL)	11	55	TL202V-11PKC	23	115	TL202V-23PKC
Voltage	300V (UL)	12	60	TL202V-12PKC	24	120	TL202V-24PKC
Approval Bodies		13	65	TL202V-13PKC			

TL203V-xxPKC

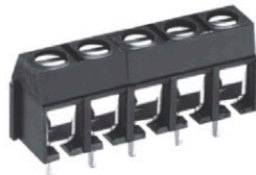
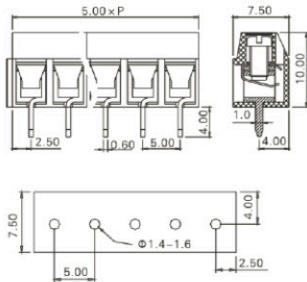

2-24 Pole Screw Wire Protector Wave - through hole Vertical 10mm pitch

		N° of Poles	Pole Length (mm)	Product Code	N° of Poles	Pole Length (mm)	Product Code
Pitch (mm)	5	2	10	TL203V-02PKC	14	70	TL203V-14PKC
Wire Size AWG	Min: 26 / Max: 12	3	15	TL203V-03PKC	15	75	TL203V-15PKC
Wire Size (mm ²)	Min: 0.5 / Max: 2.5	4	20	TL203V-04PKC	16	80	TL203V-16PKC
PCB Hole Ø	1.4-1.6	5	25	TL203V-05PKC	17	85	TL203V-17PKC
Orientation	Vertical	6	30	TL203V-06PKC	18	90	TL203V-18PKC
Mount Type	Wave - Through Hole	7	35	TL203V-07PKC	19	95	TL203V-19PKC
Screw	Cross Head	8	40	TL203V-08PKC	20	100	TL203V-20PKC
Join	Interlocking	9	45	TL203V-09PKC	21	105	TL203V-21PKC
Colour	Green or Black	10	50	TL203V-10PKC	22	110	TL203V-22PKC
Current	16A (UL) / 16A (VDE)	11	55	TL203V-11PKC	23	115	TL203V-23PKC
Voltage	300V (UL) / 250V (VDE)	12	60	TL203V-12PKC	24	120	TL203V-24PKC
Approval Bodies		13	65	TL203V-13PKC			

TL210-xxP

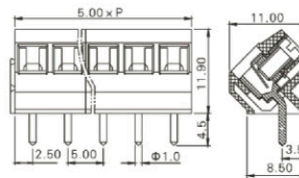

2-24 Pole Screw Wire Protector Wave - through hole Vertical 5mm pitch

		N° of Poles	Pole Length (mm)	Product Code	N° of Poles	Pole Length (mm)	Product Code
Pitch (mm)	5	2	10	TL210-02P	14	70	TL210-14P
Wire Size AWG	Min: 22 / Max: 14	3	15	TL210-03P	15	75	TL210-15P
Wire Size (mm ²)	Min: 0.34 / Max: 2.5	4	20	TL210-04P	16	80	TL210-16P
PCB Hole Ø	1.2-1.4	5	25	TL210-05P	17	85	TL210-17P
Orientation	Vertical	6	30	TL210-06P	18	90	TL210-18P
Mount Type	Wave - Through Hole	7	35	TL210-07P	19	95	TL210-19P
Screw	Slot Screw	8	40	TL210-08P	20	100	TL210-20P
Join	Interlocking	9	45	TL210-09P	21	105	TL210-21P
Colour	Green or Black	10	50	TL210-10P	22	110	TL210-22P
Current	15A	11	55	TL210-11P	23	115	TL210-23P
Voltage	300V	12	60	TL210-12P	24	120	TL210-24P
Approval Bodies		13	65	TL210-13P			

*xx = number of poles

PCB TERMINAL BLOCKS THROUGH HOLE MOUNTING / WIRE PROTECTED

TL213-xxP

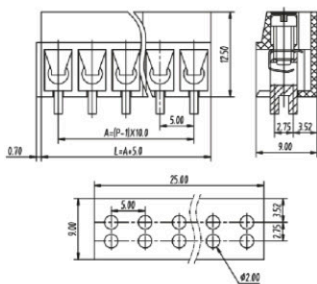

2-24 Pole Screw Wire Protector Wave -
through hole Vertical 5mm pitch

		N° of Poles	Pole Length (mm)	Product Code	N° of Poles	Pole Length (mm)	Product Code
Pitch (mm)	5	2	10	TL213-02P	14	70	TL213-14P
Wire Size AWG	Min: 22 / Max: 14	3	15	TL213-03P	15	75	TL213-15P
Wire Size (mm ²)	Min: 0.34 / Max: 2.5	4	20	TL213-04P	16	80	TL213-16P
PCB Hole Ø	1.9-2.2	5	25	TL213-05P	17	85	TL213-17P
Orientation	Vertical	6	30	TL213-06P	18	90	TL213-18P
Mount Type	Wave - Through Hole	7	35	TL213-07P	19	95	TL213-19P
Screw	Slot Screw	8	40	TL213-08P	20	100	TL213-20P
Join	Interlocking	9	45	TL213-09P	21	105	TL213-21P
Colour	Green or Black	10	50	TL213-10P	22	110	TL213-22P
Current	16A (UL)	11	55	TL213-11P	23	115	TL213-23P
Voltage	300V (UL)	12	60	TL213-12P	24	120	TL213-24P
Approval Bodies	UL (Applying)	13	65	TL213-13P			

TL209R-xxPBS

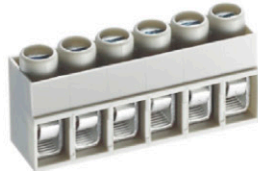
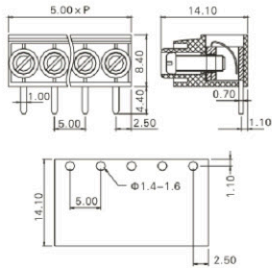

2-24 Pole Screw Wire Protector Wave -
through hole Vertical 5mm pitch

		N° of Poles	Pole Length (mm)	Product Code	N° of Poles	Pole Length (mm)	Product Code
Pitch (mm)	5	2	10	TL209R-02PBS	14	70	TL209R-14PBS
Wire Size AWG	Min: 22 / Max: 12	3	15	TL209R-03PBS	15	75	TL209R-15PBS
Wire Size (mm ²)	Min: 0.34 / Max: 4	4	20	TL209R-04PBS	16	80	TL209R-16PBS
PCB Hole Ø	1.4-1.6	5	25	TL209R-05PBS	17	85	TL209R-17PBS
Orientation	Vertical	6	30	TL209R-06PBS	18	90	TL209R-18PBS
Mount Type	Wave - Through Hole	7	35	TL209R-07PBS	19	95	TL209R-19PBS
Screw	Slot Screw	8	40	TL209R-08PBS	20	100	TL209R-20PBS
Join	Solid body non stackable	9	45	TL209R-09PBS	21	105	TL209R-21PBS
Colour	Beige	10	50	TL209R-10PBS	22	110	TL209R-22PBS
Current	15A (UL)	11	55	TL209R-11PBS	23	115	TL209R-23PBS
Voltage	250V (UL)	12	60	TL209R-12PBS	24	120	TL209R-24PBS
Approval Bodies	UL	13	65	TL209R-13PBS			

TL209V-xxPBS

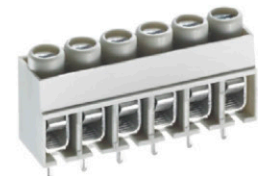
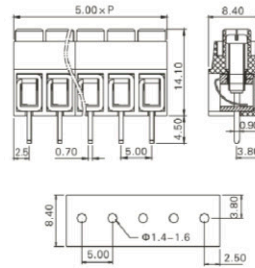

2-24 Pole Screw Wire Protector Wave -
through hole Vertical 5mm pitch

		N° of Poles	Pole Length (mm)	Product Code	N° of Poles	Pole Length (mm)	Product Code
Pitch (mm)	5	2	10	TL209V-02PBS	14	70	TL209V-14PBS
Wire Size AWG	Min: 22 / Max: 12	3	15	TL209V-03PBS	15	75	TL209V-15PBS
Wire Size (mm ²)	Min: 0.34 / Max: 4	4	20	TL209V-04PBS	16	80	TL209V-16PBS
PCB Hole Ø	1.4-1.6	5	25	TL209V-05PBS	17	85	TL209V-17PBS
Orientation	Vertical	6	30	TL209V-06PBS	18	90	TL209V-18PBS
Mount Type	Wave - Through Hole	7	35	TL209V-07PBS	19	95	TL209V-19PBS
Screw	Slot Screw	8	40	TL209V-08PBS	20	100	TL209V-20PBS
Join	Solid body non stackable	9	45	TL209V-09PBS	21	105	TL209V-21PBS
Colour	Beige	10	50	TL209V-10PBS	22	110	TL209V-22PBS
Current	15A (UL)	11	55	TL209V-11PBS	23	115	TL209V-23PBS
Voltage	250V (UL)	12	60	TL209V-12PBS	24	120	TL209V-24PBS
Approval Bodies	UL	13	65	TL209V-13PBS			

Features:

- Relevant approvals in place or applied for
- All standard pitch configurations available
- All PCB Mounting Connectors are through board suitable for wave soldering
- Most items are available in 2-24 poles
- Standard colour options include Green or Black

TL216-xxPGS

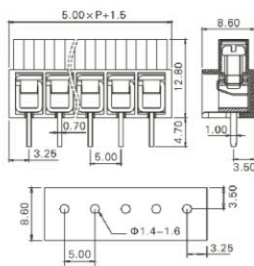

2-24 Pole Screw Wire Protector Wave-through hole Vertical 5mm pitch

		N° of Poles	Pole Length (mm)	Product Code	N° of Poles	Pole Length (mm)	Product Code
Pitch (mm)	5	2	10	TL216-02PGS	14	70	TL216-14PGS
Wire Size AWG	Min: 18 / Max: 12	3	15	TL216-03PGS	15	75	TL216-15PGS
Wire Size (mm ²)	Min: 0.75 / Max: 4	4	20	TL216-04PGS	16	80	TL216-16PGS
PCB Hole Ø	1.4-1.6	5	25	TL216-05PGS	17	85	TL216-17PGS
Orientation	Vertical	6	30	TL216-06PGS	18	90	TL216-18PGS
Mount Type	Wave - Through Hole	7	35	TL216-07PGS	19	95	TL216-19PGS
Screw	Slot Screw	8	40	TL216-08PGS	20	100	TL216-20PGS
Join	Solid body non stackable	9	45	TL216-09PGS	21	105	TL216-21PGS
Colour	Green or Black	10	50	TL216-10PGS	22	110	TL216-22PGS
Current	12A	11	55	TL216-11PGS	23	115	TL216-23PGS
Voltage	450V	12	60	TL216-12PGS	24	120	TL216-24PGS
Approval Bodies		13	65	TL216-13PGS			

TL226V-xxPGS

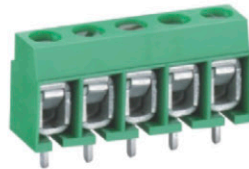
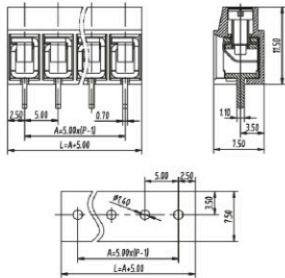

2-24 Pole Screw Wire Protector Wave-through hole Vertical 5mm pitch

		N° of Poles	Pole Length (mm)	Product Code	N° of Poles	Pole Length (mm)	Product Code
Pitch (mm)	5	2	10	TL226V-02PGS	14	70	TL226V-14PGS
Wire Size AWG	Min: 30 / Max: 12	3	15	TL226V-03PGS	15	75	TL226V-15PGS
Wire Size (mm ²)	Min 0.5 / Max: 4	4	20	TL226V-04PGS	16	80	TL226V-16PGS
PCB Hole Ø	1.4	5	25	TL226V-05PGS	17	85	TL226V-17PGS
Orientation	Vertical	6	30	TL226V-06PGS	18	90	TL226V-18PGS
Mount Type	Wave - Through Hole	7	35	TL226V-07PGS	19	95	TL226V-19PGS
Screw	Slot Screw	8	40	TL226V-08PGS	20	100	TL226V-20PGS
Join	Solid body non stackable	9	45	TL226V-09PGS	21	105	TL226V-21PGS
Colour	Green or Black	10	50	TL226V-10PGS	22	110	TL226V-22PGS
Current	16A (UL) / 24A (VDE)	11	55	TL226V-11PGS	23	115	TL226V-23PGS
Voltage	300V (UL) / 250V (VDE)	12	60	TL226V-12PGS	24	120	TL226V-24PGS
Approval Bodies		13	65	TL226V-13PGS			

TL300R-xxPKC

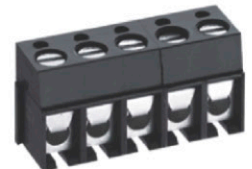
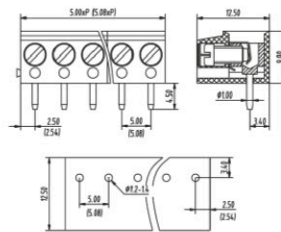

2-24 Pole Screw Wire Protector Wave-through hole Horizontal 5,08mm pitch

		N° of Poles	Pole Length (mm)	Product Code	N° of Poles	Pole Length (mm)	Product Code
Pitch (mm)	5.08	2	10.16	TL300R-02PKC	14	71.12	TL300R-14PKC
Wire Size AWG	Min: 22 / Max: 14	3	15.24	TL300R-03PKC	15	76.2	TL300R-15PKC
Wire Size (mm ²)	Min: 0.5 / Max: 2.5	4	20.32	TL300R-04PKC	16	81.28	TL300R-16PKC
PCB Hole Ø	1.2-1.4	5	25.4	TL300R-05PKC	17	86.36	TL300R-17PKC
Orientation	Horizontal	6	30.48	TL300R-06PKC	18	91.44	TL300R-18PKC
Mount Type	Wave - Through Hole	7	35.56	TL300R-07PKC	19	96.52	TL300R-19PKC
Screw	Cross Head	8	40.64	TL300R-08PKC	20	101.6	TL300R-20PKC
Join	Interlocking	9	45.72	TL300R-09PKC	21	106.68	TL300R-21PKC
Colour	Green or Black	10	50.8	TL300R-10PKC	22	111.76	TL300R-22PKC
Current	16A (UL) / 24A (VDE)	11	55.88	TL300R-11PKC	23	116.84	TL300R-23PKC
Voltage	300V (UL) / 250V (VDE)	12	60.96	TL300R-12PKC	24	121.92	TL300R-24PKC
Approval Bodies		13	66.04	TL300R-13PKC			

*xx = number of poles

PCB TERMINAL BLOCKS THROUGH HOLE MOUNTING / WIRE PROTECTED

TL301R-xxPKC

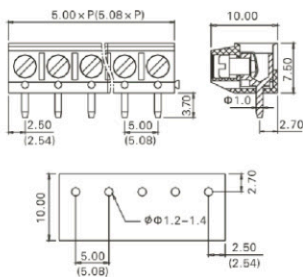

2-24 Pole Screw Wire Protector Wave - through hole Horizontal 5,08mm pitch

		N° of Poles	Pole Length (mm)	Product Code	N° of Poles	Pole Length (mm)	Product Code
Pitch (mm)	5.08	2	10.16	TL301R-02PKC	14	71.12	TL301R-14PKC
Wire Size AWG	Min: 22 / Max: 14	3	15.24	TL301R-03PKC	15	76.2	TL301R-15PKC
Wire Size (mm ²)	Min: 0.34 / Max: 2.5	4	20.32	TL301R-04PKC	16	81.28	TL301R-16PKC
PCB Hole Ø	1.2-1.4	5	25.4	TL301R-05PKC	17	86.36	TL301R-17PKC
Orientation	Horizontal	6	30.48	TL301R-06PKC	18	91.44	TL301R-18PKC
Mount Type	Wave - Through Hole	7	35.56	TL301R-07PKC	19	96.52	TL301R-19PKC
Screw	Cross Head	8	40.64	TL301R-08PKC	20	101.6	TL301R-20PKC
Join	Interlocking	9	45.72	TL301R-09PKC	21	106.68	TL301R-21PKC
Colour	Green or Black	10	50.8	TL301R-10PKC	22	111.76	TL301R-22PKC
Current	16A (UL) / 16A (VDE)	11	55.88	TL301R-11PKC	23	116.84	TL301R-23PKC
Voltage	300V (UL) / 130V (VDE)	12	60.96	TL301R-12PKC	24	121.92	TL301R-24PKC
Approval Bodies		13	66.04	TL301R-13PKC			

TL300V-xxPKC

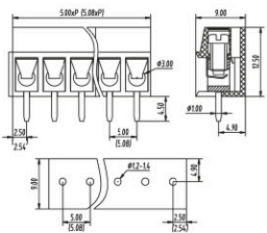

2-24 Pole Screw Wire Protector Wave - through hole Vertical 5,08mm pitch

		N° of Poles	Pole Length (mm)	Product Code	N° of Poles	Pole Length (mm)	Product Code
Pitch (mm)	5.08	2	10.16	TL300V-02PKC	14	71.12	TL300V-14PKC
Wire Size AWG	Min: 22 / Max: 14	3	15.24	TL300V-03PKC	15	76.2	TL300V-15PKC
Wire Size (mm ²)	Min: 0.5 / Max: 2.5	4	20.32	TL300V-04PKC	16	81.28	TL300V-16PKC
PCB Hole Ø	1.2-1.4	5	25.4	TL300V-05PKC	17	86.36	TL300V-17PKC
Orientation	Vertical	6	30.48	TL300V-06PKC	18	91.44	TL300V-18PKC
Mount Type	Wave - Through Hole	7	35.56	TL300V-07PKC	19	96.52	TL300V-19PKC
Screw	Cross Head	8	40.64	TL300V-08PKC	20	101.6	TL300V-20PKC
Join	Interlocking	9	45.72	TL300V-09PKC	21	106.68	TL300V-21PKC
Colour	Green or Black	10	50.8	TL300V-10PKC	22	111.76	TL300V-22PKC
Current	16A (UL) / 24A (VDE)	11	55.88	TL300V-11PKC	23	116.84	TL300V-23PKC
Voltage	300V (UL) / 250V (VDE)	12	60.96	TL300V-12PKC	24	121.92	TL300V-24PKC
Approval Bodies		13	66.04	TL300V-13PKC			

TL301V-xxPKC

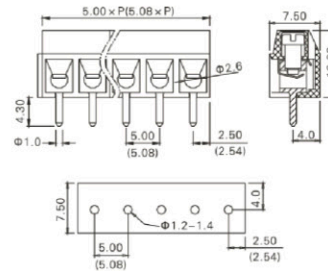

2-24 Pole Screw Wire Protector Wave - through hole Vertical 5,08mm pitch

		N° of Poles	Pole Length (mm)	Product Code	N° of Poles	Pole Length (mm)	Product Code
Pitch (mm)	5.08	2	10.16	TL301V-02PKC	14	71.12	TL301V-14PKC
Wire Size AWG	Min: 22 / Max: 14	3	15.24	TL301V-03PKC	15	76.2	TL301V-15PKC
Wire Size (mm ²)	Min: 0.34 / Max: 2.5	4	20.32	TL301V-04PKC	16	81.28	TL301V-16PKC
PCB Hole Ø	1.2-1.4	5	25.4	TL301V-05PKC	17	86.36	TL301V-17PKC
Orientation	Vertical	6	30.48	TL301V-06PKC	18	91.44	TL301V-18PKC
Mount Type	Wave - Through Hole	7	35.56	TL301V-07PKC	19	96.52	TL301V-19PKC
Screw	Cross Head	8	40.64	TL301V-08PKC	20	101.6	TL301V-20PKC
Join	Interlocking	9	45.72	TL301V-09PKC	21	106.68	TL301V-21PKC
Colour	Green or Black	10	50.8	TL301V-10PKC	22	111.76	TL301V-22PKC
Current	16A (UL) / 16A (VDE)	11	55.88	TL301V-11PKC	23	116.84	TL301V-23PKC
Voltage	300V (UL) / 130V (VDE)	12	60.96	TL301V-12PKC	24	121.92	TL301V-24PKC
Approval Bodies		13	66.04	TL301V-13PKC			

Features:

- Relevant approvals in place or applied for
- All standard pitch configurations available
- All PCB Mounting Connectors are through board suitable for wave soldering
- Most items are available in 2-24 poles
- Standard colour options include Green or Black

TL400R-xxPGS

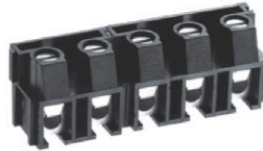
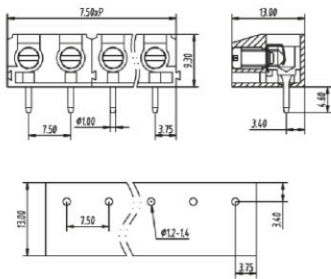

2-12 Pole Screw Wire Protector Wave - through hole Horizontal 7.5mm pitch

		N° of Poles	Pole Length (mm)	Product Code	N° of Poles	Pole Length (mm)	Product Code
Pitch (mm)	7.5	2	15	TL400R-02PGS	14	105	TL400R-14PGS
Wire Size AWG	Min: 22 / Max: 14	3	22.5	TL400R-03PGS	15	112.5	TL400R-15PGS
Wire Size (mm²)	Min: 0.5 / Max: 2.5	4	30	TL400R-04PGS	16	120	TL400R-16PGS
PCB Hole Ø	1.2-1.4	5	37.5	TL400R-05PGS	17	127.5	TL400R-17PGS
Orientation	Horizontal	6	45	TL400R-06PGS	18	135	TL400R-18PGS
Mount Type	Wave - Through Hole	7	52.5	TL400R-07PGS	19	142.5	TL400R-19PGS
Screw	Slot Screw	8	60	TL400R-08PGS	20	150	TL400R-20PGS
Join	Interlocking	9	67.5	TL400R-09PGS	21	157.5	TL400R-21PGS
Colour	Green or Black	10	75	TL400R-10PGS	22	165	TL400R-22PGS
Current	16A (UL) / 24A (VDE)	11	82.5	TL400R-11PGS	23	172.5	TL400R-23PGS
Voltage	300V (UL) / 450V (VDE)	12	90	TL400R-12PGS	24	180	TL400R-24PGS
Approval Bodies		13	97.5	TL400R-13PGS			

TL400V-xxPGS

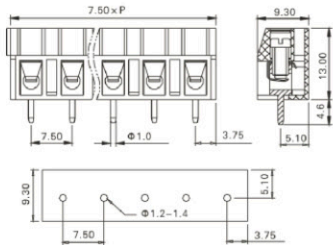

2-24 Pole Screw Wire Protector Wave - through hole Vertical 7.5mm pitch

		N° of Poles	Pole Length (mm)	Product Code	N° of Poles	Pole Length (mm)	Product Code
Pitch (mm)	7.5	2	15	TL401V-02PGS	14	105	TL401V-14PGS
Wire Size AWG	Min: 22 / Max: 14	3	22.5	TL401V-03PGS	15	112.5	TL401V-15PGS
Wire Size (mm²)	Min: 0.5 / Max: 2.5	4	30	TL401V-04PGS	16	120	TL401V-16PGS
PCB Hole Ø	1.2-1.4	5	37.5	TL401V-05PGS	17	127.5	TL401V-17PGS
Orientation	Vertical	6	45	TL401V-06PGS	18	135	TL401V-18PGS
Mount Type	Wave - Through Hole	7	52.5	TL401V-07PGS	19	142.5	TL401V-19PGS
Screw	Slot Screw	8	60	TL401V-08PGS	20	150	TL401V-20PGS
Join	Interlocking	9	67.5	TL401V-09PGS	21	157.5	TL401V-21PGS
Colour	Green or Black	10	75	TL401V-10PGS	22	165	TL401V-22PGS
Current	16A (UL) / 24A (VDE)	11	82.5	TL401V-11PGS	23	172.5	TL401V-23PGS
Voltage	300V (UL) / 450V (VDE)	12	90	TL401V-12PGS	24	180	TL401V-24PGS
Approval Bodies		13	97.5	TL401V-13PGS			

TL523-xxPGS

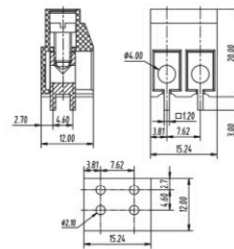

2 Pole Wire Protector Wave - through hole Vertical 7.62mm pitch

		N° of Poles	Pole Length (mm)	Product Code	N° of Poles	Pole Length (mm)	Product Code
Pitch (mm)	7.62	2	15.24	TL523-02PGS			
Wire Size AWG	Min: 30 / Max: 8						
Wire Size (mm²)	Max: 10						
PCB Hole Ø	0.2-2.1						
Orientation	Vertical						
Mount Type	Wave - Through Hole						
Screw	Slot Screw						
Join	Solid body non stackable						
Colour	Green or Black						
Current	35A (UL)						
Voltage	300V (UL)						
Approval Bodies							

*xx = number of poles

PCB TERMINAL BLOCKS THROUGH HOLE MOUNTING / WIRE PROTECTED

TL200R-xxP5KC

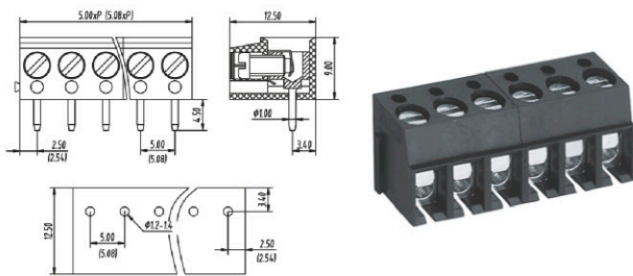

2-12 Pole Screw Wire Protector Wave - through hole Horizontal 10mm pitch

		N° of Poles	Pole Length (mm)	Product Code	N° of Poles	Pole Length (mm)	Product Code
Pitch (mm)	10	2	15	TL200R-02P5KC			
Wire Size AWG	Min: 22 / Max: 14	3	25	TL200R-03P5KC			
Wire Size (mm ²)	Min: 0.5 / Max: 2.5	4	35	TL200R-04P5KC			
PCB Hole Ø	1.2-1.4	5	45	TL200R-05P5KC			
Orientation	Horizontal	6	55	TL200R-06P5KC			
Mount Type	Wave - Through Hole	7	65	TL200R-07P5KC			
Screw	Cross Head	8	75	TL200R-08P5KC			
Join	Interlocking	9	85	TL200R-09P5KC			
Colour	Green or Black	10	95	TL200R-10P5KC			
Current	16A (UL) / 24A (VDE)	11	105	TL200R-11P5KC			
Voltage	300V (UL) / 250V (VDE)	12	115	TL200R-12P5KC			
Approval Bodies							

TL201R-xxP5KC

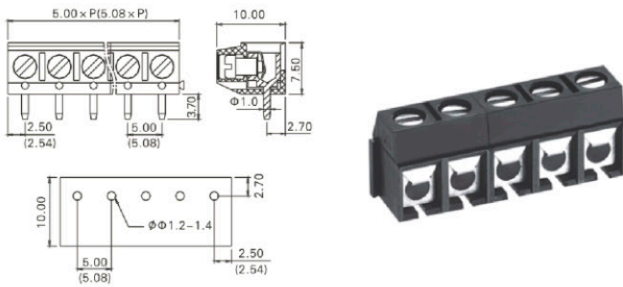

2-12 Pole Screw Wire Protector Wave - through hole Horizontal 10mm pitch

		N° of Poles	Pole Length (mm)	Product Code	N° of Poles	Pole Length (mm)	Product Code
Pitch (mm)	10	2	15	TL201R-02P5KC			
Wire Size AWG	Min: 20 / Max: 14	3	25	TL201R-03P5KC			
Wire Size (mm ²)	Min: 0.34 / Max: 2.5	4	35	TL201R-04P5KC			
PCB Hole Ø	1.2-1.4	5	45	TL201R-05P5KC			
Orientation	Horizontal	6	55	TL201R-06P5KC			
Mount Type	Wave - Through Hole	7	65	TL201R-07P5KC			
Screw	Cross Head	8	75	TL201R-08P5KC			
Join	Interlocking	9	85	TL201R-09P5KC			
Colour	Green or Black	10	95	TL201R-10P5KC			
Current	16A (UL) / 16A (VDE)	11	105	TL201R-11P5KC			
Voltage	300V (UL) / 130V (VDE)	12	115	TL201R-12P5KC			
Approval Bodies							

TL200V-xxP5KC

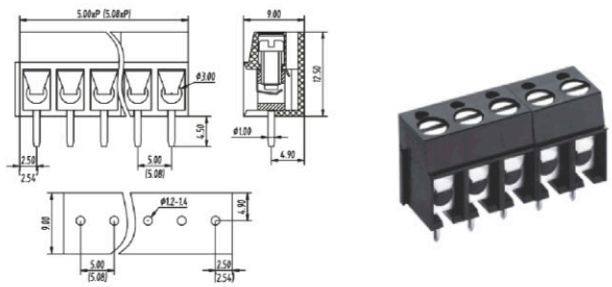

2-12 Pole Screw Wire Protector Wave - through hole Vertical 10mm pitch

		N° of Poles	Pole Length (mm)	Product Code	N° of Poles	Pole Length (mm)	Product Code
Pitch (mm)	10	2	15	TL200V-02P5KC			
Wire Size AWG	Min: 22 / Max: 14	3	25	TL200V-03P5KC			
Wire Size (mm ²)	Min: 0.5 / Max: 2.5	4	35	TL200V-04P5KC			
PCB Hole Ø	1.2-1.4	5	45	TL200V-05P5KC			
Orientation	Vertical	6	55	TL200V-06P5KC			
Mount Type	Wave - Through Hole	7	65	TL200V-07P5KC			
Screw	Cross Head	8	75	TL200V-08P5KC			
Join	Interlocking	9	85	TL200V-09P5KC			
Colour	Green or Black	10	95	TL200V-10P5KC			
Current	16A (UL) / 24A (VDE)	11	105	TL200V-11P5KC			
Voltage	300V (UL) / 250V (VDE)	12	115	TL200V-12P5KC			
Approval Bodies							

Features:

- Relevant approvals in place or applied for
- All standard pitch configurations available
- All PCB Mounting Connectors are through board suitable for wave soldering
- Most items are available in 2-24 poles
- Standard colour options include Green or Black

TL201V-xxP5KC

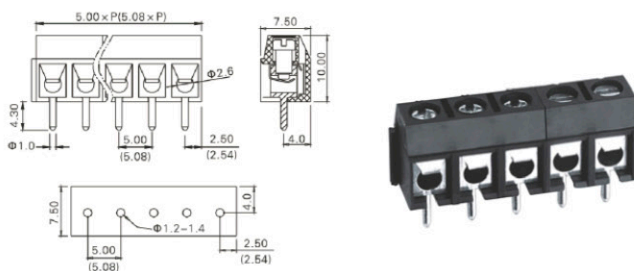

2-12 Pole Screw Wire Protector Wave - through hole Vertical 10mm pitch

		N° of Poles	Pole Length (mm)	Product Code	N° of Poles	Pole Length (mm)	Product Code
Pitch (mm)	10	2	15	TL201V-02P5KC			
Wire Size AWG	Min: 20 / Max: 14	3	25	TL201V-03P5KC			
Wire Size (mm ²)	Min: 0.34 / Max: 2.5	4	35	TL201V-04P5KC			
PCB Hole Ø	1.2-1.4	5	45	TL201V-05P5KC			
Orientation	Vertical	6	55	TL201V-06P5KC			
Mount Type	Wave - Through Hole	7	65	TL201V-07P5KC			
Screw	Cross Head	8	75	TL201V-08P5KC			
Join	Interlocking	9	85	TL201V-09P5KC			
Colour	Green or Black	10	95	TL201V-10P5KC			
Current	16A (UL) / 16A (VDE)	11	105	TL201V-11P5KC			
Voltage	300V (UL) / 130V (VDE)	12	115	TL201V-12P5KC			
Approval Bodies							

TL202V-xxP5KC

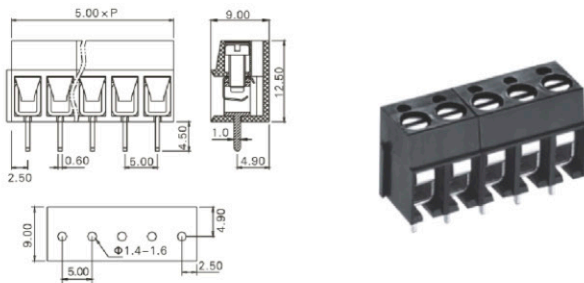

2-12 Pole Screw Wire Protector Wave - through hole Vertical 10mm pitch

		N° of Poles	Pole Length (mm)	Product Code	N° of Poles	Pole Length (mm)	Product Code
Pitch (mm)	10	2	15	TL202V-02P5KC			
Wire Size AWG	Min: 22 / Mx: 12	3	25	TL202V-03P5KC			
Wire Size (mm ²)	Min: 0.34 / Max: 4	4	35	TL202V-04P5KC			
PCB Hole Ø	1.4-1.6	5	45	TL202V-05P5KC			
Orientation	Vertical	6	55	TL202V-06P5KC			
Mount Type	Wave - Through Hole	7	65	TL202V-07P5KC			
Screw	Cross Head	8	75	TL202V-08P5KC			
Join	Interlocking	9	85	TL202V-09P5KC			
Colour	Green or Black	10	95	TL202V-10P5KC			
Current	16A (UL)	11	105	TL202V-11P5KC			
Voltage		12	115	TL202V-12P5KC			
Approval Bodies							

TL203V-xxP5KC

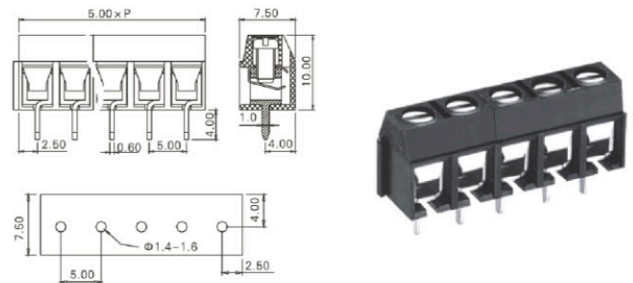

2-12 Pole Screw Wire Protector Wave - through hole Vertical 10mm pitch

		N° of Poles	Pole Length (mm)	Product Code	N° of Poles	Pole Length (mm)	Product Code
Pitch (mm)	10	2	15	TL203V-02P5KC			
Wire Size AWG	Min 26 / Min: 12	3	25	TL203V-03P5KC			
Wire Size (mm ²)	Min: 0.5 / Max: 2.5	4	35	TL203V-04P5KC			
PCB Hole Ø	1.4-1.6	5	45	TL203V-05P5KC			
Orientation	Vertical	6	55	TL203V-06P5KC			
Mount Type	Wave - Through Hole	7	65	TL203V-07P5KC			
Screw	Cross Head	8	75	TL203V-08P5KC			
Join	Interlocking	9	85	TL203V-09P5KC			
Colour	Green or Black	10	95	TL203V-10P5KC			
Current	16A (UL) / 16A (VDE)	11	105	TL203V-11P5KC			
Voltage	350V (UL) / 250V (VDE)	12	115	TL203V-12P5KC			
Approval Bodies							

*xx = number of poles

PCB TERMINAL BLOCKS THROUGH HOLE MOUNTING / WIRE PROTECTED

TL216-xxP5GS

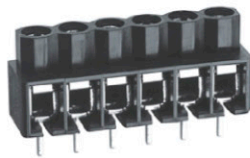
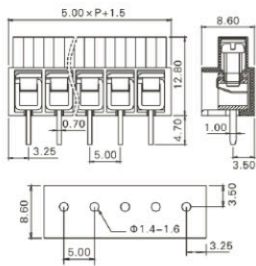

2-12 Pole Screw Wire Protector Wave - through hole Vertical 10mm pitch

		N° of Poles	Pole Length (mm)	Product Code	N° of Poles	Pole Length (mm)	Product Code
Pitch (mm)	10	2	16.5	TL216-02P5GS			
Wire Size AWG	Min: 18 / Max: 12	3	26.5	TL216-03P5GS			
Wire Size (mm ²)	Min: 0.75 / Max: 4	4	36.5	TL216-04P5GS			
PCB Hole Ø	1.4-1.6	5	46.5	TL216-05P5GS			
Orientation	Vertical	6	56.5	TL216-06P5GS			
Mount Type	Wave - Through Hole	7	66.5	TL216-07P5GS			
Screw	Slot Screw	8	76.5	TL216-08P5GS			
Join	Interlocking	9	86.5	TL216-09P5GS			
Colour	Green or Black	10	96.5	TL216-10P5GS			
Current	12A (UL) / 12A (VDE)	11	106.5	TL216-11P5GS			
Voltage	300V (UL) / 450 (VDE)	12	116.5	TL216-12P5GS			
Approval Bodies							

TL300R-xxPKC

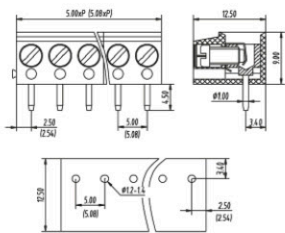

2-24 Pole Screw Wire Protector Wave - through hole Horizontal 5,08mm pitch

		N° of Poles	Pole Length (mm)	Product Code	N° of Poles	Pole Length (mm)	Product Code
Pitch (mm)	5.08	2	10.16	TL300R-02PKC	14	71.12	TL300R-14PKC
Wire Size AWG	Min: 22 / Max: 14	3	15.24	TL300R-03PKC	15	76.2	TL300R-15PKC
Wire Size (mm ²)	Min: 0.5 / Max: 2.5	4	20.32	TL300R-04PKC	16	81.28	TL300R-16PKC
PCB Hole Ø	1.2-1.4	5	25.4	TL300R-05PKC	17	86.36	TL300R-17PKC
Orientation	Horizontal	6	30.48	TL300R-06PKC	18	91.44	TL300R-18PKC
Mount Type	Wave - Through Hole	7	35.56	TL300R-07PKC	19	96.52	TL300R-19PKC
Screw	Cross Head	8	40.64	TL300R-08PKC	20	101.6	TL300R-20PKC
Join	Interlocking	9	45.72	TL300R-09PKC	21	106.68	TL300R-21PKC
Colour	Green or Black	10	50.8	TL300R-10PKC	22	111.76	TL300R-22PKC
Current	16A (UL) / 24A (VDE)	11	55.88	TL300R-11PKC	23	116.84	TL300R-23PKC
Voltage	300V (UL) / 250V (VDE)	12	60.96	TL300R-12PKC	24	121.92	TL300R-24PKC
Approval Bodies		13	66.04	TL300R-13PKC			

TL301R-xxPKC

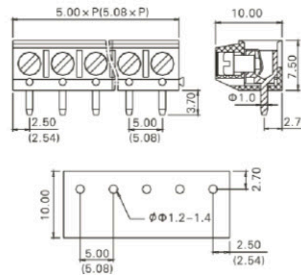

2-24 Pole Screw Wire Protector Wave - through hole Horizontal 5,08mm pitch

		N° of Poles	Pole Length (mm)	Product Code	N° of Poles	Pole Length (mm)	Product Code
Pitch (mm)	5.08	2	10.16	TL301R-02PKC	14	71.12	TL301R-14PKC
Wire Size AWG	Min: 22 / Max: 14	3	15.24	TL301R-03PKC	15	76.2	TL301R-15PKC
Wire Size (mm ²)	Min: 0.34 / Max: 2.5	4	20.32	TL301R-04PKC	16	81.28	TL301R-16PKC
PCB Hole Ø	1.2-1.4	5	25.4	TL301R-05PKC	17	86.36	TL301R-17PKC
Orientation	Horizontal	6	30.48	TL301R-06PKC	18	91.44	TL301R-18PKC
Mount Type	Wave - Through Hole	7	35.56	TL301R-07PKC	19	96.52	TL301R-19PKC
Screw	Cross Head	8	40.64	TL301R-08PKC	20	101.6	TL301R-20PKC
Join	Interlocking	9	45.72	TL301R-09PKC	21	106.68	TL301R-21PKC
Colour	Green or Black	10	50.8	TL301R-10PKC	22	111.76	TL301R-22PKC
Current	16A (UL) / 16A (VDE)	11	55.88	TL301R-11PKC	23	116.84	TL301R-23PKC
Voltage	300V (UL) / 130V (VDE)	12	60.96	TL301R-12PKC	24	121.92	TL301R-24PKC
Approval Bodies		13	66.04	TL301R-13PKC			

PCB TERMINAL BLOCKS RISING CLAMP - SINGLE ROW

TL004R-xxPGS

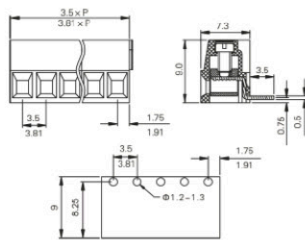

2-24 Pole Screw Rising Clamp
Horizontal 3.5mm pitch

		N° of Poles	Pole Length (mm)	Product Code	N° of Poles	Pole Length (mm)	Product Code
Pitch (mm)	3.5	2	7	TL004R-02PGS	15	52.5	TL004R-15PGS
Wire Size AWG	Min: 26 / Max: 16	3	10.5	TL004R-03PGS	16	56	TL004R-16PGS
Wire Size (mm ²)	Min: 0.2 / Max: 1.5	4	14	TL004R-04PGS	17	59.5	TL004R-17PGS
PCB Hole Ø	1.2-1.3	5	17.5	TL004R-05PGS	18	63	TL004R-18PGS
Orientation	Horizontal	6	21	TL004R-06PGS	19	66.5	TL004R-19PGS
Mount Type	Horizontal	7	24.5	TL004R-07PGS	20	70	TL004R-20PGS
Screw	Slot Screw	8	28	TL004R-08PGS	21	73.5	TL004R-21PGS
Join	Interlocking	9	31.5	TL004R-09PGS	22	77	TL004R-22PGS
Colour	Green or Black	10	35	TL004R-10PGS	23	80.5	TL004R-23PGS
Length (mm)		11	38.5	TL004R-11PGS	24	84	TL004R-24PGS
Current	10A (UL)	12	42	TL004R-12PGS			
Voltage	300V (UL)	13	45.5	TL004R-13PGS			
Approval Bodies		14	49	TL004R-14PGS			

TL004V-xxPGS

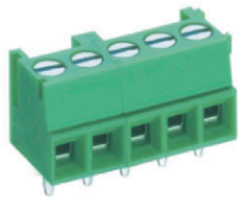
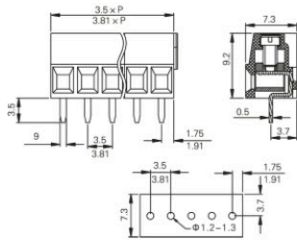

2-24 Pole Screw Rising Clamp
Vertical 3.5mm pitch

		N° of Poles	Pole Length (mm)	Product Code	N° of Poles	Pole Length (mm)	Product Code
Pitch (mm)	3.5	2	7	TL004V-02PGS	14	49	TL004V-14PGS
Wire Size AWG	Min: 26 / Max: 16	3	10.5	TL004V-03PGS	15	52.5	TL004V-15PGS
Wire Size (mm ²)	Min: 0.2 / Max: 1.5	4	14	TL004V-04PGS	16	56	TL004V-16PGS
PCB Hole Ø	1.2-1.3	5	17.5	TL004V-05PGS	17	59.5	TL004V-17PGS
Orientation	Vertical	6	21	TL004V-06PGS	18	63	TL004V-18PGS
Mount Type	Vertical	7	24.5	TL004V-07PGS	19	66.5	TL004V-19PGS
Screw	Slot Screw	8	28	TL004V-08PGS	20	70	TL004V-20PGS
Join	Interlocking	9	31.5	TL004V-09PGS	21	73.5	TL004V-21PGS
Colour	Green or Black	10	35	TL004V-10PGS	22	77	TL004V-22PGS
Current	10A (UL)	11	38.5	TL004V-11PGS	23	80.5	TL004V-23PGS
Voltage	300V (UL)	12	42	TL004V-12PGS	24	84	TL004V-24PGS
Approval Bodies		13	45.5	TL004V-13PGS			

TL002V-xxPGS

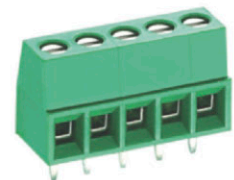
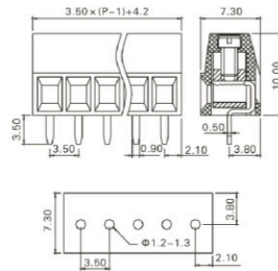

2-24 Pole Screw Rising Clamp Wave-
through hole Vertical 3.5mm pitch

		N° of Poles	Pole Length (mm)	Product Code	N° of Poles	Pole Length (mm)	Product Code
Pitch (mm)	3.5	2	7.7	TL002V-02PGS	14	49.7	TL002V-14PGS
Wire Size AWG	Min: 26 / Max: 16	3	11.2	TL002V-03PGS	15	53.2	TL002V-15PGS
Wire Size (mm ²)	Min: 0.2 / Max: 1.5	4	14.7	TL002V-04PGS	16	56.7	TL002V-16PGS
PCB Hole Ø	1.2-1.3	5	18.2	TL002V-05PGS	17	60.2	TL002V-17PGS
Orientation	Vertical	6	21.7	TL002V-06PGS	18	63.7	TL002V-18PGS
Mount Type	Wave - Through Hole	7	25.2	TL002V-07PGS	19	67.2	TL002V-19PGS
Screw	Slot Screw	8	28.7	TL002V-08PGS	20	70.7	TL002V-20PGS
Join	Interlocking	9	32.2	TL002V-09PGS	21	74.2	TL002V-21PGS
Colour	Green or Black	10	35.7	TL002V-10PGS	22	77.7	TL002V-22PGS
Current	10A (UL) / 10A (VDE)	11	39.2	TL002V-11PGS	23	81.2	TL002V-23PGS
Voltage	300V (UL) / 130V (VDE)	12	42.7	TL002V-12PGS	24	84.7	TL002V-24PGS
Approval Bodies		13	46.2	TL002V-13PGS			

TL010-xxPKS

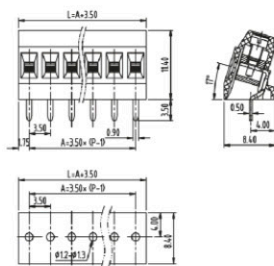

2-24 Pole Screw Rising Clamp
17 degree 17 degree 3.5mm pitch

		N° of Poles	Pole Length (mm)	Product Code	N° of Poles	Pole Length (mm)	Product Code
Pitch (mm)	3.5	2	7	TL010-02PKS	14	49	TL010-14PKS
Wire Size AWG	Min: 26 / Max: 16	3	10.5	TL010-03PKS	15	52.5	TL010-15PKS
Wire Size (mm ²)	Min: 0.2 / Max: 1.5	4	14	TL010-04PKS	16	56	TL010-16PKS
PCB Hole Ø	1.2-1.3	5	17.5	TL010-05PKS	17	59.5	TL010-17PKS
Orientation	17 degree	6	21	TL010-06PKS	18	63	TL010-18PKS
Mount Type	17 degree	7	24.5	TL010-07PKS	19	66.5	TL010-19PKS
Screw	Slot Screw	8	28	TL010-08PKS	20	70	TL010-20PKS
Join	Solid body non stackable	9	31.5	TL010-09PKS	21	73.5	TL010-21PKS
Colour	Green or Black	10	35	TL010-10PKS	22	77	TL010-22PKS
Current	10A (UL)	11	38.5	TL010-11PKS	23	80.5	TL010-23PKS
Voltage	300V (VDE)	12	42	TL010-12PKS	24	84	TL010-24PKS
Approval Bodies	UL (Applying)	13	45.5	TL010-13PKS			

TL009-xxPKS

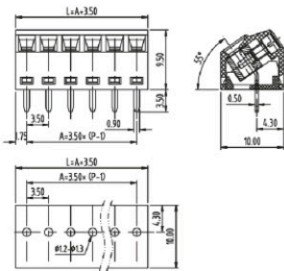

2-24 Pole Screw Rising Clamp
55 degree 55 degree 3.5mm pitch

		N° of Poles	Pole Length (mm)	Product Code	N° of Poles	Pole Length (mm)	Product Code
Pitch (mm)	3.5	2	7	TL009-02PKS	14	49	TL009-14PKS
Wire Size AWG	Min: 26 / Max: 16	3	10.5	TL009-03PKS	15	52.5	TL009-15PKS
Wire Size (mm ²)	Min: 0.2 / Max: 1.5	4	14	TL009-04PKS	16	56	TL009-16PKS
PCB Hole Ø	1.2-1.3	5	17.5	TL009-05PKS	17	59.5	TL009-17PKS
Orientation	55 degree	6	21	TL009-06PKS	18	63	TL009-18PKS
Mount Type	55 degree	7	24.5	TL009-07PKS	19	66.5	TL009-19PKS
Screw	Slot Screw	8	28	TL009-08PKS	20	70	TL009-20PKS
Join	Solid body non stackable	9	31.5	TL009-09PKS	21	73.5	TL009-21PKS
Colour	Green or Black	10	35	TL009-10PKS	22	77	TL009-22PKS
Current	10A (UL)	11	38.5	TL009-11PKS	23	80.5	TL009-23PKS
Voltage	300V (VDE)	12	42	TL009-12PKS	24	84	TL009-24PKS
Approval Bodies	UL	13	45.5	TL009-13PKS			

TL003V-xxPGS

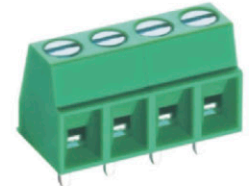
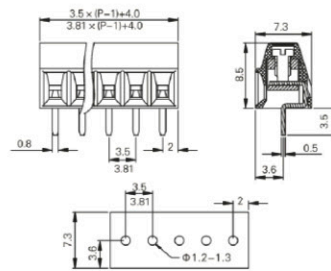

2-24 Pole Screw Rising Clamp
Vertical 3.5mm pitch

		N° of Poles	Pole Length (mm)	Product Code	N° of Poles	Pole Length (mm)	Product Code
Pitch (mm)	3.5	2	7.5	TL003V-02PGS	14	49.5	TL003V-14PGS
Wire Size AWG	Min: 26 / Max: 16	3	11	TL003V-03PGS	15	53	TL003V-15PGS
Wire Size (mm ²)	Min: 0.2 / Max: 1.5	4	14.5	TL003V-04PGS	16	56.5	TL003V-16PGS
PCB Hole Ø	1.2-1.3	5	18	TL003V-05PGS	17	60	TL003V-17PGS
Orientation	Vertical	6	21.5	TL003V-06PGS	18	63.5	TL003V-18PGS
Mount Type	Vertical	7	25	TL003V-07PGS	19	67	TL003V-19PGS
Screw	Slot Screw	8	28.5	TL003V-08PGS	20	70.5	TL003V-20PGS
Join	Solid body non stackable	9	32	TL003V-09PGS	21	74	TL003V-21PGS
Colour	Green or Black	10	35.5	TL003V-10PGS	22	77.5	TL003V-22PGS
Current	10A (UL)	11	39	TL003V-11PGS	23	81	TL003V-23PGS
Voltage	300V (UL)	12	42.5	TL003V-12PGS	24	84.5	TL003V-24PGS
Approval Bodies	UL	13	46	TL003V-13PGS			

*xx = number of poles

PCB TERMINAL BLOCKS RISING CLAMP - SINGLE ROW

TL104R-xxPGS

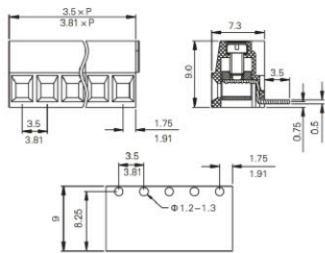

2-24 Pole Screw Rising Clamp
Horizontal 3.81mm pitch

		N° of Poles	Pole Length (mm)	Product Code	N° of Poles	Pole Length (mm)	Product Code
Pitch (mm)	3.81	2	7.62	TL104R-02PGS	15	57.15	TL104R-15PGS
Wire Size AWG	Min: 26 / Max: 16	3	11.43	TL104R-03PGS	16	60.96	TL104R-16PGS
Wire Size (mm ²)	Min: 0.2 / Max: 1.5	4	15.24	TL104R-04PGS	17	64.77	TL104R-17PGS
PCB Hole Ø	1.2-1.3	5	19.05	TL104R-05PGS	18	68.58	TL104R-18PGS
Orientation	Horizontal	6	22.86	TL104R-06PGS	19	72.39	TL104R-19PGS
Mount Type	Horizontal	7	26.67	TL104R-07PGS	20	76.2	TL104R-20PGS
Screw	Slot Screw	8	30.48	TL104R-08PGS	21	80.01	TL104R-21PGS
Join	Interlocking	9	34.29	TL104R-09PGS	22	83.82	TL104R-22PGS
Colour	Green or Black	10	38.1	TL104R-10PGS	23	87.63	TL104R-23PGS
Length (mm)		11	41.91	TL104R-11PGS	24	91.44	TL104R-24PGS
Current	10A (UL)	12	45.72	TL104R-12PGS			
Voltage	300V (UL)	13	49.53	TL104R-13PGS			
Approval Bodies		14	53.34	TL104R-14PGS			

TL104V-xxPGS

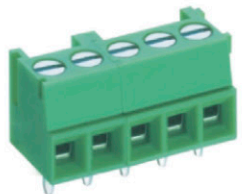
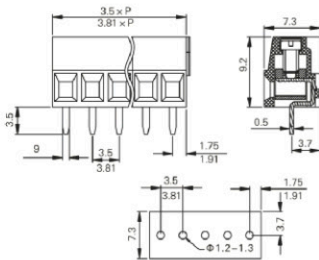

2-24 Pole Screw Rising Clamp
Vertical 3.81mm pitch

		N° of Poles	Pole Length (mm)	Product Code	N° of Poles	Pole Length (mm)	Product Code
Pitch (mm)	3.81	2	7.62	TL104V-02PGS	14	53.34	TL104V-14PGS
Wire Size AWG	Min: 26 / Max: 16	3	11.43	TL104V-03PGS	15	57.15	TL104V-15PGS
Wire Size (mm ²)	Min: 0.2 / Max: 1.5	4	15.24	TL104V-04PGS	16	60.96	TL104V-16PGS
PCB Hole Ø	1.2-1.3	5	19.05	TL104V-05PGS	17	64.77	TL104V-17PGS
Orientation	Vertical	6	22.86	TL104V-06PGS	18	68.58	TL104V-18PGS
Mount Type	Vertical	7	26.67	TL104V-07PGS	19	72.39	TL104V-19PGS
Screw	Slot Screw	8	30.48	TL104V-08PGS	20	76.2	TL104V-20PGS
Join	Interlocking	9	34.29	TL104V-09PGS	21	80.01	TL104V-21PGS
Colour	Green or Black	10	38.1	TL104V-10PGS	22	83.82	TL104V-22PGS
Current	10A (UL)	11	41.91	TL104V-11PGS	23	87.63	TL104V-23PGS
Voltage	300V (UL)	12	45.72	TL104V-12PGS	24	91.44	TL104V-24PGS
Approval Bodies		13	49.53	TL104V-13PGS			

TL103V-xxPGS

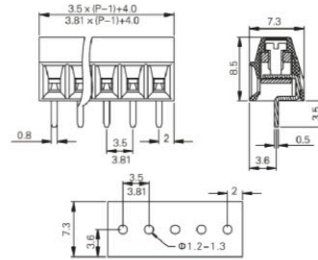

2-24 Pole Screw Rising Clamp
Vertical 3.81mm pitch

		N° of Poles	Pole Length (mm)	Product Code	N° of Poles	Pole Length (mm)	Product Code
Pitch (mm)	3.81	2	7.81	TL103V-02PGS	14	53.53	TL103V-14PGS
Wire Size AWG	Min: 26 / Max: 16	3	11.62	TL103V-03PGS	15	57.34	TL103V-15PGS
Wire Size (mm ²)	Min: 0.2 / Max: 1.5	4	15.43	TL103V-04PGS	16	61.15	TL103V-16PGS
PCB Hole Ø	1.2-1.3	5	19.24	TL103V-05PGS	17	64.96	TL103V-17PGS
Orientation	Vertical	6	23.05	TL103V-06PGS	18	68.77	TL103V-18PGS
Mount Type	Vertical	7	26.86	TL103V-07PGS	19	72.58	TL103V-19PGS
Screw	Slot Screw	8	30.67	TL103V-08PGS	20	76.39	TL103V-20PGS
Join	Solid body non stackable	9	34.48	TL103V-09PGS	21	80.2	TL103V-21PGS
Colour	Green or Black	10	38.29	TL103V-10PGS	22	84.01	TL103V-22PGS
Current	10A (UL)	11	42.1	TL103V-11PGS	23	87.82	TL103V-23PGS
Voltage	300V (UL)	12	45.91	TL103V-12PGS	24	91.63	TL103V-24PGS
Approval Bodies		13	49.72	TL103V-13PGS			

TL220RA-xxPGS

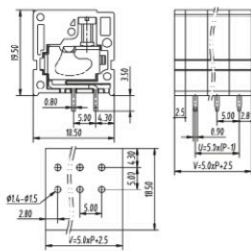

2-24 Pole Screw Rising Clamp
 Horizontal 5mm pitch

		N° of Poles	Pole Length (mm)	Product Code	N° of Poles	Pole Length (mm)	Product Code
Pitch (mm)	5	2	12.5	TL220RA-02PGS	14	72.5	TL220RA-14PGS
Wire Size AWG	Min: 28 / Max: 12	3	17.5	TL220RA-03PGS	15	77.5	TL220RA-15PGS
Wire Size (mm ²)	Max: 4	4	22.5	TL220RA-04PGS	16	82.5	TL220RA-16PGS
PCB Hole Ø	1.4-1.5	5	27.5	TL220RA-05PGS	17	87.5	TL220RA-17PGS
Orientation	Horizontal	6	32.5	TL220RA-06PGS	18	92.5	TL220RA-18PGS
Mount Type	Horizontal	7	37.5	TL220RA-07PGS	19	97.5	TL220RA-19PGS
Screw	Slot Screw	8	42.5	TL220RA-08PGS	20	102.5	TL220RA-20PGS
Join	End Stackable	9	47.5	TL220RA-09PGS	21	107.5	TL220RA-21PGS
Colour	Green or Black	10	52.5	TL220RA-10PGS	22	112.5	TL220RA-22PGS
Current	20A (UL)	11	57.5	TL220RA-11PGS	23	117.5	TL220RA-23PGS
Voltage	300V (UL)	12	62.5	TL220RA-12PGS	24	122.5	TL220RA-24PGS
Approval Bodies		13	67.5	TL220RA-13PGS			

TL220VA-xxPGS

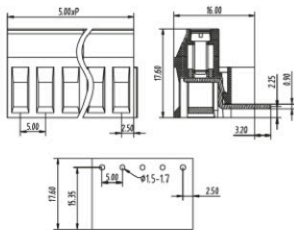

2-24 Pole Screw Rising Clamp
 Vertical 5mm pitch

		N° of Poles	Pole Length (mm)	Product Code	N° of Poles	Pole Length (mm)	Product Code
Pitch (mm)	5	2	10	TL220VA-02PGS	14	72.5	TL220VA-14PGS
Wire Size AWG	Min: 28 / Max: 12	3	17.5	TL220VA-03PGS	15	77.5	TL220VA-15PGS
Wire Size (mm ²)	Max: 4	4	22.5	TL220VA-04PGS	16	82.5	TL220VA-16PGS
PCB Hole Ø	1.4-1.5	5	27.5	TL220VA-05PGS	17	87.5	TL220VA-17PGS
Orientation	Vertical	6	32.5	TL220VA-06PGS	18	92.5	TL220VA-18PGS
Mount Type	Vertical	7	37.5	TL220VA-07PGS	19	97.5	TL220VA-19PGS
Screw	Slot Screw	8	42.5	TL220VA-08PGS	20	102.5	TL220VA-20PGS
Join	End Stackable	9	47.5	TL220VA-09PGS	21	107.5	TL220VA-21PGS
Colour	Green or Black	10	52.5	TL220VA-10PGS	22	112.5	TL220VA-22PGS
Current	20A (UL)	11	57.5	TL220VA-11PGS	23	117.5	TL220VA-23PGS
Voltage	300V (UL)	12	62.5	TL220VA-12PGS	24	122.5	TL220VA-24PGS
Approval Bodies		13	67.5	TL220VA-13PGS			

TL214R-xxPGS

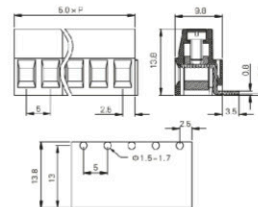

2-24 Pole Screw Rising Clamp
 Horizontal 5mm pitch

		N° of Poles	Pole Length (mm)	Product Code	N° of Poles	Pole Length (mm)	Product Code
Pitch (mm)	5	2	10	TL214R-02PGS	14	70	TL214R-14PGS
Wire Size AWG	Min: 24 / Max: 12	3	15	TL214R-03PGS	15	75	TL214R-15PGS
Wire Size (mm ²)	Min: 0.2 / Max: 4	4	20	TL214R-04PGS	16	80	TL214R-16PGS
PCB Hole Ø	1.5-1.7	5	25	TL214R-05PGS	17	85	TL214R-17PGS
Orientation	Horizontal	6	30	TL214R-06PGS	18	90	TL214R-18PGS
Mount Type	Horizontal	7	35	TL214R-07PGS	19	95	TL214R-19PGS
Screw	Slot Screw	8	40	TL214R-08PGS	20	100	TL214R-20PGS
Join	Interlocking	9	45	TL214R-09PGS	21	105	TL214R-21PGS
Colour	Green or Black	10	50	TL214R-10PGS	22	110	TL214R-22PGS
Current	20A (UL)	11	55	TL214R-11PGS	23	115	TL214R-23PGS
Voltage	300V (UL)	12	60	TL214R-12PGS	24	120	TL214R-24PGS
Approval Bodies		13	65	TL214R-13PGS			

*xx = number of poles

PCB TERMINAL BLOCKS RISING CLAMP - SINGLE ROW

TL215R-xxPGS

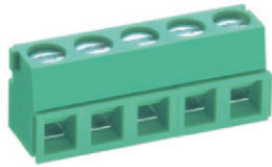
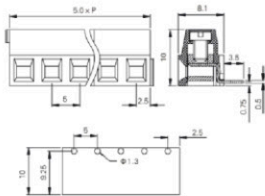

2-24 Pole Screw Rising Clamp
Horizontal 5mm pitch

		N° of Poles	Pole Length (mm)	Product Code	N° of Poles	Pole Length (mm)	Product Code
Pitch (mm)	5	2	10	TL215R-02PGS	14	70	TL215R-14PGS
Wire Size AWG	Min: 26 / Max: 16	3	15	TL215R-03PGS	15	75	TL215R-15PGS
Wire Size (mm ²)	Min: 0.2 / Max: 1.5	4	20	TL215R-04PGS	16	80	TL215R-16PGS
PCB Hole Ø	1.3	5	25	TL215R-05PGS	17	85	TL215R-17PGS
Orientation	Horizontal	6	30	TL215R-06PGS	18	90	TL215R-18PGS
Mount Type	Horizontal	7	35	TL215R-07PGS	19	95	TL215R-19PGS
Screw	Slot Screw	8	40	TL215R-08PGS	20	100	TL215R-20PGS
Join	Interlocking	9	45	TL215R-09PGS	21	105	TL215R-21PGS
Colour	Green or Black	10	50	TL215R-10PGS	22	110	TL215R-22PGS
Current	10A (UL)	11	55	TL215R-11PGS	23	115	TL215R-23PGS
Voltage	300V (UL)	12	60	TL215R-12PGS	24	120	TL215R-24PGS
Approval Bodies		13	65	TL215R-13PGS			

TL227R-xxPGS

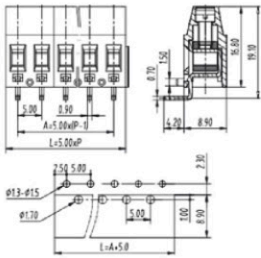

2-24 Pole Screw Rising Clamp
Horizontal 5mm pitch

		N° of Poles	Pole Length (mm)	Product Code	N° of Poles	Pole Length (mm)	Product Code
Pitch (mm)	5	2	10	TL227R-02PGS	14	70	TL227R-14PGS
Wire Size AWG	Min: 24 / Max: 14	3	15	TL227R-03PGS	15	75	TL227R-15PGS
Wire Size (mm ²)	Min: 0.2 / Max: 2.5	4	20	TL227R-04PGS	16	80	TL227R-16PGS
PCB Hole Ø	1.3-1.5	5	25	TL227R-05PGS	17	85	TL227R-17PGS
Orientation	Horizontal	6	30	TL227R-06PGS	18	90	TL227R-18PGS
Mount Type	Horizontal	7	35	TL227R-07PGS	19	95	TL227R-19PGS
Screw	Slot Screw	8	40	TL227R-08PGS	20	100	TL227R-20PGS
Join	Interlocking	9	45	TL227R-09PGS	21	105	TL227R-21PGS
Colour	Green or Black	10	50	TL227R-10PGS	22	110	TL227R-22PGS
Current	15A (UL)	11	55	TL227R-11PGS	23	115	TL227R-23PGS
Voltage	300V (UL)	12	60	TL227R-12PGS	24	120	TL227R-24PGS
Approval Bodies		13	65	TL227R-13PGS			

TL217R-xxPGS

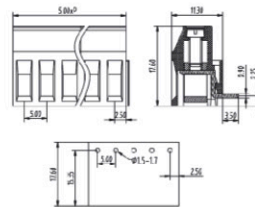

2-24 Pole Screw Rising Clamp
Horizontal 5mm pitch

		N° of Poles	Pole Length (mm)	Product Code	N° of Poles	Pole Length (mm)	Product Code
Pitch (mm)	5	2	10	TL217R-02PGS	14	70	TL217R-14PGS
Wire Size AWG	Min: 24 / Max: 12	3	15	TL217R-03PGS	15	75	TL217R-15PGS
Wire Size (mm ²)	Min: 0.2 / Max: 4	4	20	TL217R-04PGS	16	80	TL217R-16PGS
PCB Hole Ø	1.5-1.7	5	25	TL217R-05PGS	17	85	TL217R-17PGS
Orientation	Horizontal	6	30	TL217R-06PGS	18	90	TL217R-18PGS
Mount Type	Horizontal	7	35	TL217R-07PGS	19	95	TL217R-19PGS
Screw	Slot Screw	8	40	TL217R-08PGS	20	100	TL217R-20PGS
Join	Interlocking	9	45	TL217R-09PGS	21	105	TL217R-21PGS
Colour	Green or Beige	10	50	TL217R-10PGS	22	110	TL217R-22PGS
Current	20A (UL)	11	55	TL217R-11PGS	23	115	TL217R-23PGS
Voltage	300V (UL)	12	60	TL217R-12PGS	24	120	TL217R-24PGS
Approval Bodies		13	65	TL217R-13PGS			

TL218R-xxPGS

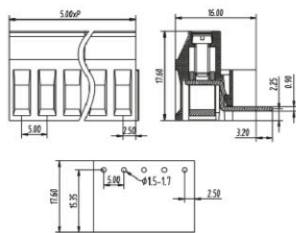

2-24 Pole Screw Rising Clamp
Horizontal 5mm pitch

		N° of Poles	Pole Length (mm)	Product Code	N° of Poles	Pole Length (mm)	Product Code
Pitch (mm)	5	2	10	TL218R-02PGS	14	70	TL218R-14PGS
Wire Size AWG	Min: 24 / Max: 12	3	15	TL218R-03PGS	15	75	TL218R-15PGS
Wire Size (mm ²)	Min: 0.2 / Max: 4	4	20	TL218R-04PGS	16	80	TL218R-16PGS
PCB Hole Ø	1.5-1.7	5	25	TL218R-05PGS	17	85	TL218R-17PGS
Orientation	Horizontal	6	30	TL218R-06PGS	18	90	TL218R-18PGS
Mount Type	Horizontal	7	35	TL218R-07PGS	19	95	TL218R-19PGS
Screw	Slot Screw	8	40	TL218R-08PGS	20	100	TL218R-20PGS
Join	Interlocking	9	45	TL218R-09PGS	21	105	TL218R-21PGS
Colour	Green or Beige	10	50	TL218R-10PGS	22	110	TL218R-22PGS
Current	20A (UL)	11	55	TL218R-11PGS	23	115	TL218R-23PGS
Voltage	300V (UL)	12	60	TL218R-12PGS	24	120	TL218R-24PGS
Approval Bodies		13	65	TL218R-13PGS			

TL214V-xxPGS

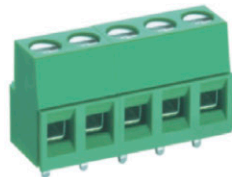
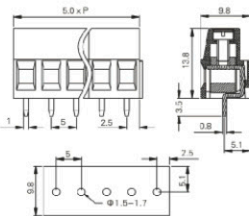

2-24 Pole Screw Rising Clamp
Vertical 5mm pitch

		N° of Poles	Pole Length (mm)	Product Code	N° of Poles	Pole Length (mm)	Product Code
Pitch (mm)	5	2	10	TL214V-02PGS	14	70	TL214V-14PGS
Wire Size AWG	Min: 24 / Max: 12	3	15	TL214V-03PGS	15	75	TL214V-15PGS
Wire Size (mm ²)	Min: 0.2 / Max: 4	4	20	TL214V-04PGS	16	80	TL214V-16PGS
PCB Hole Ø	1.5-1.7	5	25	TL214V-05PGS	17	85	TL214V-17PGS
Orientation	Vertical	6	30	TL214V-06PGS	18	90	TL214V-18PGS
Mount Type	Vertical	7	35	TL214V-07PGS	19	95	TL214V-19PGS
Screw	Slot Screw	8	40	TL214V-08PGS	20	100	TL214V-20PGS
Join	Interlocking	9	45	TL214V-09PGS	21	105	TL214V-21PGS
Colour	Green or Black	10	50	TL214V-10PGS	22	110	TL214V-22PGS
Current	20A (UL)	11	55	TL214V-11PGS	23	115	TL214V-23PGS
Voltage	300V (UL)	12	60	TL214V-12PGS	24	120	TL214V-24PGS
Approval Bodies		13	65	TL214V-13PGS			

TL215V-xxPGS

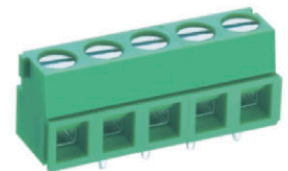
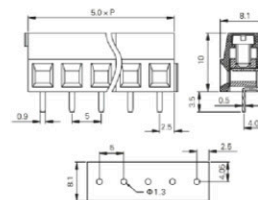

2-24 Pole Screw Rising Clamp
Vertical 5mm pitch

		N° of Poles	Pole Length (mm)	Product Code	N° of Poles	Pole Length (mm)	Product Code
Pitch (mm)	5	2	10	TL215V-02PGS	14	70	TL215V-14PGS
Wire Size AWG	Min: 26 / Max: 16	3	15	TL215V-03PGS	15	75	TL215V-15PGS
Wire Size (mm ²)	Min: 0.2 / Max: 1.5	4	20	TL215V-04PGS	16	80	TL215V-16PGS
PCB Hole Ø	1.3	5	25	TL215V-05PGS	17	85	TL215V-17PGS
Orientation	Vertical	6	30	TL215V-06PGS	18	90	TL215V-18PGS
Mount Type	Vertical	7	35	TL215V-07PGS	19	95	TL215V-19PGS
Screw	Slot Screw	8	40	TL215V-08PGS	20	100	TL215V-20PGS
Join	Interlocking	9	45	TL215V-09PGS	21	105	TL215V-21PGS
Colour	Green or Black	10	50	TL215V-10PGS	22	110	TL215V-22PGS
Current	10A (UL)	11	55	TL215V-11PGS	23	115	TL215V-23PGS
Voltage	300V (UL)	12	60	TL215V-12PGS	24	120	TL215V-24PGS
Approval Bodies		13	65	TL215V-13PGS			

*xx = number of poles

PCB TERMINAL BLOCKS RISING CLAMP - SINGLE ROW

TL217V01-xxPGS

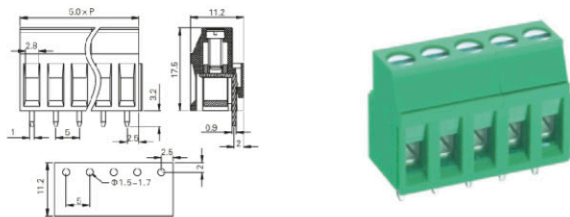

2-24 Pole Screw Rising Clamp
Vertical 5mm pitch

		N° of Poles	Pole Length (mm)	Product Code	N° of Poles	Pole Length (mm)	Product Code
Pitch (mm)	5	2	10	TL217V01-02PGS	14	70	TL217V01-14PGS
Wire Size AWG	Min: 24 / Max: 12	3	15	TL217V01-03PGS	15	75	TL217V01-15PGS
Wire Size (mm ²)	Min: 0.2 / Max: 4	4	20	TL217V01-04PGS	16	80	TL217V01-16PGS
PCB Hole Ø	1.5-1.7	5	25	TL217V01-05PGS	17	85	TL217V01-17PGS
Orientation	Vertical	6	30	TL217V01-06PGS	18	90	TL217V01-18PGS
Mount Type	Vertical	7	35	TL217V01-07PGS	19	95	TL217V01-19PGS
Screw	Slot Screw	8	40	TL217V01-08PGS	20	100	TL217V01-20PGS
Join	Interlocking	9	45	TL217V01-09PGS	21	105	TL217V01-21PGS
Colour	Green or Beige	10	50	TL217V01-10PGS	22	110	TL217V01-22PGS
Current	20A (UL)	11	55	TL217V01-11PGS	23	115	TL217V01-23PGS
Voltage	300V (UL)	12	60	TL217V01-12PGS	24	120	TL217V01-24PGS
Approval Bodies		13	65	TL217V01-13PGS			

TL217V-xxPGS

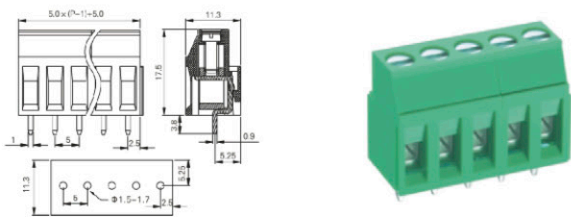

2-24 Pole Screw Rising Clamp
Vertical 5mm pitch

		N° of Poles	Pole Length (mm)	Product Code	N° of Poles	Pole Length (mm)	Product Code
Pitch (mm)	5	2	10	TL217V-02PGS	14	70	TL217V-14PGS
Wire Size AWG	Min: 24 / Max: 12	3	15	TL217V-03PGS	15	75	TL217V-15PGS
Wire Size (mm ²)	Min: 0.2 / Max: 4	4	20	TL217V-04PGS	16	80	TL217V-16PGS
PCB Hole Ø	1.5-1.7	5	25	TL217V-05PGS	17	85	TL217V-17PGS
Orientation	Vertical	6	30	TL217V-06PGS	18	90	TL217V-18PGS
Mount Type	Vertical	7	35	TL217V-07PGS	19	95	TL217V-19PGS
Screw	Slot Screw	8	40	TL217V-08PGS	20	100	TL217V-20PGS
Join	Interlocking	9	45	TL217V-09PGS	21	105	TL217V-21PGS
Colour	Green or Beige	10	50	TL217V-10PGS	22	110	TL217V-22PGS
Current	20A (UL)	11	55	TL217V-11PGS	23	115	TL217V-23PGS
Voltage	300V (UL)	12	60	TL217V-12PGS	24	120	TL217V-24PGS
Approval Bodies		13	65	TL217V-13PGS			

TL207-xxPGS

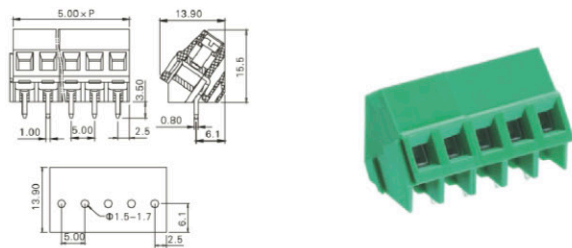

2-24 Pole Screw Rising Clamp Wave -
through hole 35 degree 5mm pitch

		N° of Poles	Pole Length (mm)	Product Code	N° of Poles	Pole Length (mm)	Product Code
Pitch (mm)	5	2	10	TL207-02PGS	14	70	TL207-14PGS
Wire Size AWG	Min: 24 / Max: 12	3	15	TL207-03PGS	15	75	TL207-15PGS
Wire Size (mm ²)	Min: 0.2 / Max: 4	4	20	TL207-04PGS	16	80	TL207-16PGS
PCB Hole Ø	1.5-1.7	5	25	TL207-05PGS	17	85	TL207-17PGS
Orientation	35 degree	6	30	TL207-06PGS	18	90	TL207-18PGS
Mount Type	Wave - Through Hole	7	35	TL207-07PGS	19	95	TL207-19PGS
Screw	Slot Screw	8	40	TL207-08PGS	20	100	TL207-20PGS
Join	Interlocking	9	45	TL207-09PGS	21	105	TL207-21PGS
Colour	Green or Black	10	50	TL207-10PGS	22	110	TL207-22PGS
Current	12A (UL)	11	55	TL207-11PGS	23	115	TL207-23PGS
Voltage	250V (UL)	12	60	TL207-12PGS	24	120	TL207-24PGS
Approval Bodies		13	65	TL207-13PGS			

TL204-xxKS

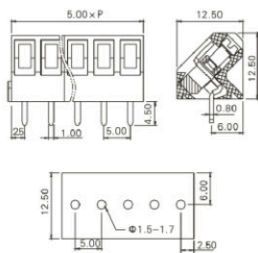

2-24 Pole Screw Rising Clamp Wave - through hole 45 degree 5mm pitch

		N° of Poles	Pole Length (mm)	Product Code	N° of Poles	Pole Length (mm)	Product Code
Pitch (mm)	5	2	10	TL204R-02KS	14	70	TL204R-14KS
Wire Size AWG	Min: 26 / Max: 12	3	15	TL204R-03KS	15	75	TL204R-15KS
Wire Size (mm²)	Min: 0.2 / Max: 2.5	4	20	TL204R-04KS	16	80	TL204R-16KS
PCB Hole Ø	1.5-1.7	5	25	TL204R-05KS	17	85	TL204R-17KS
Orientation	45 degree	6	30	TL204R-06KS	18	90	TL204R-18KS
Mount Type	Wave - Through Hole	7	35	TL204R-07KS	19	95	TL204R-19KS
Screw	Slot Screw	8	40	TL204R-08KS	20	100	TL204R-20KS
Join	Interlocking	9	45	TL204R-09KS	21	105	TL204R-21KS
Colour	Green or Black	10	50	TL204R-10KS	22	110	TL204R-22KS
Current	16A	11	55	TL204R-11KS	23	115	TL204R-23KS
Voltage	250V	12	60	TL204R-12KS	24	120	TL204R-24KS
Approval Bodies		13	65	TL204R-13KS			

TL204-xxPKS

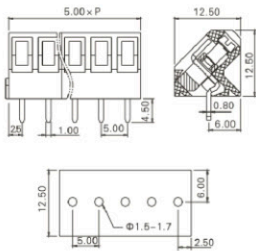

2-24 Pole Screw Rising Clamp Wave - through hole 45 degree 5mm pitch

		N° of Poles	Pole Length (mm)	Product Code	N° of Poles	Pole Length (mm)	Product Code
Pitch (mm)	5	2	10	TL204R-02PKS	14	70	TL204R-14PKS
Wire Size AWG	Min: 26 / Max: 12	3	15	TL204R-03PKS	15	75	TL204R-15PKS
Wire Size (mm²)	Min: 0.2 / Max: 2.5	4	20	TL204R-04PKS	16	80	TL204R-16PKS
PCB Hole Ø	1.5-1.7	5	25	TL204R-05PKS	17	85	TL204R-17PKS
Orientation	45 degree	6	30	TL204R-06PKS	18	90	TL204R-18PKS
Mount Type	Wave - Through Hole	7	35	TL204R-07PKS	19	95	TL204R-19PKS
Screw	Slot Screw	8	40	TL204R-08PKS	20	100	TL204R-20PKS
Join	Interlocking	9	45	TL204R-09PKS	21	105	TL204R-21PKS
Colour	Green or Black	10	50	TL204R-10PKS	22	110	TL204R-22PKS
Current	16A (UL) / 16A (VDE)	11	55	TL204R-11PKS	23	115	TL204R-23PKS
Voltage	250V (UL) / 130V (VDE)	12	60	TL204R-12PKS	24	120	TL204R-24PKS
Approval Bodies		13	65	TL204R-13PKS			

TL206R-xxPGS

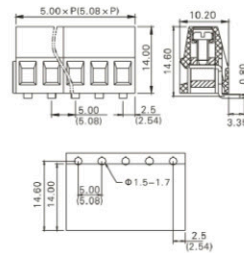

2-24 Pole Screw Rising Clamp Wave - through hole Horizontal 5mm pitch

		N° of Poles	Pole Length (mm)	Product Code	N° of Poles	Pole Length (mm)	Product Code
Pitch (mm)	5	2	10	TL206R-02PGS	14	70	TL206R-14PGS
Wire Size AWG	Min: 24 / Max: 12	3	15	TL206R-03PGS	15	75	TL206R-15PGS
Wire Size (mm²)	Min: 0.5 / Max: 2.5	4	20	TL206R-04PGS	16	80	TL206R-16PGS
PCB Hole Ø	1.5-1.7	5	25	TL206R-05PGS	17	85	TL206R-17PGS
Orientation	Horizontal	6	30	TL206R-06PGS	18	90	TL206R-18PGS
Mount Type	Wave - Through Hole	7	35	TL206R-07PGS	19	95	TL206R-19PGS
Screw	Slot Screw	8	40	TL206R-08PGS	20	100	TL206R-20PGS
Join	Interlocking	9	45	TL206R-09PGS	21	105	TL206R-21PGS
Colour	Green or Black	10	50	TL206R-10PGS	22	110	TL206R-22PGS
Current	20A (UL) / 12A (VDE)	11	55	TL206R-11PGS	23	115	TL206R-23PGS
Voltage	300V (UL) / 250V (VDE)	12	60	TL206R-12PGS	24	120	TL206R-24PGS
Approval Bodies		13	65	TL206R-13PGS			

*xx = number of poles

PCB TERMINAL BLOCKS RISING CLAMP - SINGLE ROW

TL206V-xxPGS

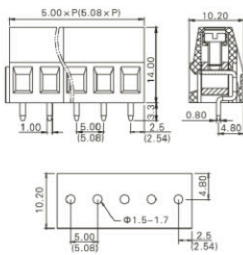

2-24 Pole Screw Rising Clamp Wave - through hole Vertical 5mm pitch

		N° of Poles	Pole Length (mm)	Product Code	N° of Poles	Pole Length (mm)	Product Code
Pitch (mm)	5	2	10	TL206V-02PGS	14	70	TL206V-14PGS
Wire Size AWG	Min: 24 / Max: 12	3	15	TL206V-03PGS	15	75	TL206V-15PGS
Wire Size (mm ²)	Min: 0.5 / Max: 2.5	4	20	TL206V-04PGS	16	80	TL206V-16PGS
PCB Hole Ø	1.5-1.7	5	25	TL206V-05PGS	17	85	TL206V-17PGS
Orientation	Vertical	6	30	TL206V-06PGS	18	90	TL206V-18PGS
Mount Type	Wave - Through Hole	7	35	TL206V-07PGS	19	95	TL206V-19PGS
Screw	Slot Screw	8	40	TL206V-08PGS	20	100	TL206V-20PGS
Join	Interlocking	9	45	TL206V-09PGS	21	105	TL206V-21PGS
Colour	Green or Black	10	50	TL206V-10PGS	22	110	TL206V-22PGS
Current	20A (UL) / 12A (VDE)	11	55	TL206V-11PGS	23	115	TL206V-23PGS
Voltage	300V (UL) / 250V (VDE)	12	60	TL206V-12PGS	24	120	TL206V-24PGS
Approval Bodies		13	65	TL206V-13PGS			

TL206VT-xxPGS

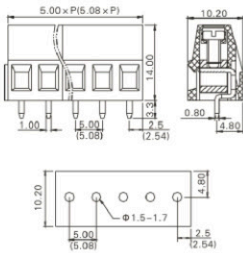

2-24 Pole Screw Rising Clamp Wave - through hole Vertical 5mm pitch

		N° of Poles	Pole Length (mm)	Product Code	N° of Poles	Pole Length (mm)	Product Code
Pitch (mm)	5	2	10	TL206VT-02PGS	14	70	TL206VT-14PGS
Wire Size AWG	Min: 24 / Max: 12	3	15	TL206VT-03PGS	15	75	TL206VT-15PGS
Wire Size (mm ²)	Min: 0.5 / Max: 2.5	4	20	TL206VT-04PGS	16	80	TL206VT-16PGS
PCB Hole Ø	1.5-1.7	5	25	TL206VT-05PGS	17	85	TL206VT-17PGS
Orientation	Vertical	6	30	TL206VT-06PGS	18	90	TL206VT-18PGS
Mount Type	Wave - Through Hole	7	35	TL206VT-07PGS	19	95	TL206VT-19PGS
Screw	Slot Screw	8	40	TL206VT-08PGS	20	100	TL206VT-20PGS
Join	Interlocking	9	45	TL206VT-09PGS	21	105	TL206VT-21PGS
Colour	Green or Black	10	50	TL206VT-10PGS	22	110	TL206VT-22PGS
Current	20A (UL) / 12A (VDE)	11	55	TL206VT-11PGS	23	115	TL206VT-23PGS
Voltage	300V (UL) / 250V (VDE)	12	60	TL206VT-12PGS	24	120	TL206VT-24PGS
Approval Bodies		13	65	TL206VT-13PGS			

TL208V-xxPGS

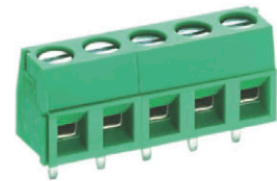
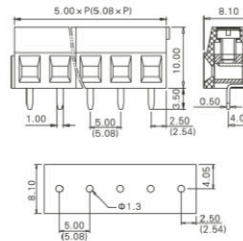

2-24 Pole Screw Rising Clamp Wave - through hole Vertical 5mm pitch

		N° of Poles	Pole Length (mm)	Product Code	N° of Poles	Pole Length (mm)	Product Code
Pitch (mm)	5	2	10	TL208V-02PGS	14	70	TL208V-14PGS
Wire Size AWG	Min: 26 / Max: 16	3	15	TL208V-03PGS	15	75	TL208V-15PGS
Wire Size (mm ²)	Min: 0.2 / Max: 1.5	4	20	TL208V-04PGS	16	80	TL208V-16PGS
PCB Hole Ø	1.3	5	25	TL208V-05PGS	17	85	TL208V-17PGS
Orientation	Vertical	6	30	TL208V-06PGS	18	90	TL208V-18PGS
Mount Type	Wave - Through Hole	7	35	TL208V-07PGS	19	95	TL208V-19PGS
Screw	Slot Screw	8	40	TL208V-08PGS	20	100	TL208V-20PGS
Join	Interlocking	9	45	TL208V-09PGS	21	105	TL208V-21PGS
Colour	Green or Black	10	50	TL208V-10PGS	22	110	TL208V-22PGS
Current	10A (UL)	11	55	TL208V-11PGS	23	115	TL208V-23PGS
Voltage	150V (UL)	12	60	TL208V-12PGS	24	120	TL208V-24PGS
Approval Bodies		13	65	TL208V-13PGS			

TL208VT-xxPGS

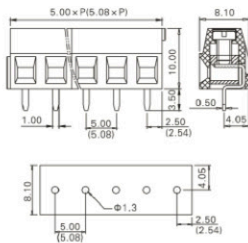

2-24 Pole Screw Rising Clamp Wave - through hole Vertical 5mm pitch

		N° of Poles	Pole Length (mm)	Product Code	N° of Poles	Pole Length (mm)	Product Code
Pitch (mm)	5	2	10	TL208VT-02PGS	14	70	TL208VT-14PGS
Wire Size AWG	Min: 26 / Max: 16	3	15	TL208VT-03PGS	15	75	TL208VT-15PGS
Wire Size (mm²)	Min: 0.2 / Max: 1.5	4	20	TL208VT-04PGS	16	80	TL208VT-16PGS
PCB Hole Ø	1.3	5	25	TL208VT-05PGS	17	85	TL208VT-17PGS
Orientation	Vertical	6	30	TL208VT-06PGS	18	90	TL208VT-18PGS
Mount Type	Wave - Through Hole	7	35	TL208VT-07PGS	19	95	TL208VT-19PGS
Screw	Slot Screw	8	40	TL208VT-08PGS	20	100	TL208VT-20PGS
Join	Interlocking	9	45	TL208VT-09PGS	21	105	TL208VT-21PGS
Colour	Green or Black	10	50	TL208VT-10PGS	22	110	TL208VT-22PGS
Current	10A (UL)	11	55	TL208VT-11PGS	23	115	TL208VT-23PGS
Voltage	150V (UL)	12	60	TL208VT-12PGS	24	120	TL208VT-24PGS
Approval Bodies		13	65	TL208VT-13PGS			

TL212V-xxPGS

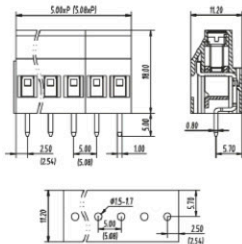

2-24 Pole Screw Rising Clamp Wave - through hole Vertical 5mm pitch

		N° of Poles	Pole Length (mm)	Product Code	N° of Poles	Pole Length (mm)	Product Code
Pitch (mm)	5	2	10	TL212V-02PGS	14	70	TL212V-14PGS
Wire Size AWG	Min: 24 / Max: 12	3	15	TL212V-03PGS	15	75	TL212V-15PGS
Wire Size (mm²)	Min: 0.34 / Max: 4	4	20	TL212V-04PGS	16	80	TL212V-16PGS
PCB Hole Ø	1.5-1.7	5	25	TL212V-05PGS	17	85	TL212V-17PGS
Orientation	Vertical	6	30	TL212V-06PGS	18	90	TL212V-18PGS
Mount Type	Wave - Through Hole	7	35	TL212V-07PGS	19	95	TL212V-19PGS
Screw	Slot Screw	8	40	TL212V-08PGS	20	100	TL212V-20PGS
Join	Interlocking	9	45	TL212V-09PGS	21	105	TL212V-21PGS
Colour	Green or Black	10	50	TL212V-10PGS	22	110	TL212V-22PGS
Current	20A (UL) / 20A (VDE)	11	55	TL212V-11PGS	23	115	TL212V-23PGS
Voltage	300V (UL) / 300V (VDE)	12	60	TL212V-12PGS	24	120	TL212V-24PGS
Approval Bodies		13	65	TL212V-13PGS			

TL225R-xxPGS

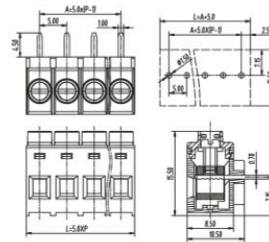

2-24 Pole Screw Rising Clamp Horizontal 5mm pitch

		N° of Poles	Pole Length (mm)	Product Code	N° of Poles	Pole Length (mm)	Product Code
Pitch (mm)	5	2	10	TL225R-02PGS	14	70	TL225R-14PGS
Wire Size AWG	Min: 26 / Max: 12	3	15	TL225R-03PGS	15	75	TL225R-15PGS
Wire Size (mm²)	Min: 0.2 / Max: 4	4	20	TL225R-04PGS	16	80	TL225R-16PGS
PCB Hole Ø	1.3-1.5	5	25	TL225R-05PGS	17	85	TL225R-17PGS
Orientation	Horizontal	6	30	TL225R-06PGS	18	90	TL225R-18PGS
Mount Type	Horizontal	7	35	TL225R-07PGS	19	95	TL225R-19PGS
Screw	Slot Screw	8	40	TL225R-08PGS	20	100	TL225R-20PGS
Join	Solid body non stackable	9	45	TL225R-09PGS	21	105	TL225R-21PGS
Colour	Green or Black	10	50	TL225R-10PGS	22	110	TL225R-22PGS
Current	16A (UL)	11	55	TL225R-11PGS	23	115	TL225R-23PGS
Voltage	300V (UL)	12	60	TL225R-12PGS	24	120	TL225R-24PGS
Approval Bodies		13	65	TL225R-13PGS			

*xx = number of poles

PCB TERMINAL BLOCKS RISING CLAMP - SINGLE ROW

TL219-xxPGS

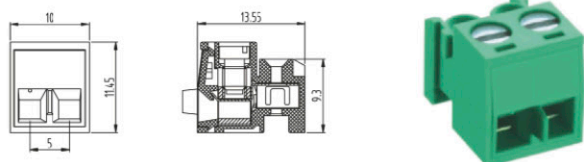

		2-24 Pole Screw Rising Clamp Vertical 5mm pitch		N° of Poles	Pole Length (mm)	Product Code	N° of Poles	Pole Length (mm)	Product Code
Pitch (mm)	5	2	10	TL219-02PGS	14	70	TL219-14PGS		
Wire Size AWG	Min: 22 / Max: 14	3	15	TL219-03PGS	15	75	TL219-15PGS		
Wire Size (mm ²)	Min: 0.34 / Max: 2.5	4	20	TL219-04PGS	16	80	TL219-16PGS		
PCB Hole Ø		5	25	TL219-05PGS	17	85	TL219-17PGS		
Orientation	Vertical	6	30	TL219-06PGS	18	90	TL219-18PGS		
Mount Type	Vertical	7	35	TL219-07PGS	19	95	TL219-19PGS		
Screw	Slot Screw	8	40	TL219-08PGS	20	100	TL219-20PGS		
Join	Slid body non stackable	9	45	TL219-09PGS	21	105	TL219-21PGS		
Colour	Green or Black	10	50	TL219-10PGS	22	110	TL219-22PGS		
Current	10A (UL)	11	55	TL219-11PGS	23	115	TL219-23PGS		
Voltage	300V (UL)	12	60	TL219-12PGS	24	120	TL219-24PGS		
Approval Bodies		13	65	TL219-13PGS					

TL225V-xxPGS

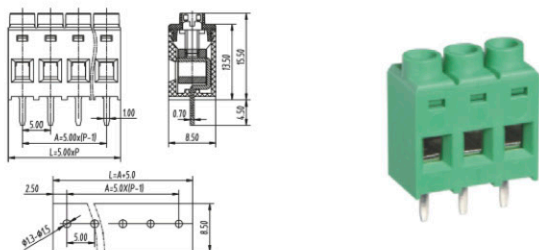

2-24 Pole Screw Rising Clamp
Vertical 5mm pitch

		2-24 Pole Screw Rising Clamp Vertical 5mm pitch		N° of Poles	Pole Length (mm)	Product Code	N° of Poles	Pole Length (mm)	Product Code
Pitch (mm)	5	2	10	TL225V-02PGS	14	70	TL225V-14PGS		
Wire Size AWG	Min: 26 / Max: 12	3	15	TL225V-03PGS	15	75	TL225V-15PGS		
Wire Size (mm ²)	Min: 0.2 / Max: 4	4	20	TL225V-04PGS	16	80	TL225V-16PGS		
PCB Hole Ø	1.3-1.5	5	25	TL225V-05PGS	17	85	TL225V-17PGS		
Orientation	Vertical	6	30	TL225V-06PGS	18	90	TL225V-18PGS		
Mount Type	Vertical	7	35	TL225V-07PGS	19	95	TL225V-19PGS		
Screw	Slot Screw	8	40	TL225V-08PGS	20	100	TL225V-20PGS		
Join	Solid body non stackable	9	45	TL225V-09PGS	21	105	TL225V-21PGS		
Colour	Green or Black	10	50	TL225V-10PGS	22	110	TL225V-22PGS		
Current	16A (UL)	11	55	TL225V-11PGS	23	115	TL225V-23PGS		
Voltage	300V (UL)	12	60	TL225V-12PGS	24	120	TL225V-24PGS		
Approval Bodies		13	65	TL225V-13PGS					

TL313V-xxPGS

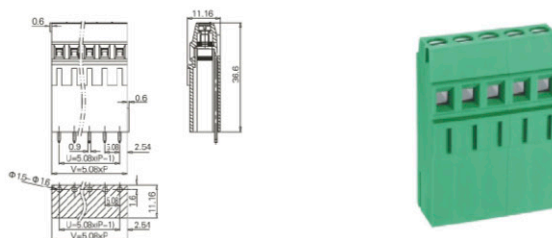

2-24 Pole Screw Rising Clamp
Vertical 5.08mm pitch

		2-24 Pole Screw Rising Clamp Vertical 5.08mm pitch		N° of Poles	Pole Length (mm)	Product Code	N° of Poles	Pole Length (mm)	Product Code
Pitch (mm)	5.08	2	10.16	TL313V-02PGS	14	71.12	TL313V-14PGS		
Wire Size AWG	Min: 30 / Max: 14	3	15.24	TL313V-03PGS	15	76.2	TL313V-15PGS		
Wire Size (mm ²)	Max: 2.5	4	20.32	TL313V-04PGS	16	81.28	TL313V-16PGS		
PCB Hole Ø	1.5-1.6	5	25.4	TL313V-05PGS	17	86.36	TL313V-17PGS		
Orientation	Vertical	6	30.48	TL313V-06PGS	18	91.44	TL313V-18PGS		
Mount Type	Vertical	7	35.56	TL313V-07PGS	19	96.52	TL313V-19PGS		
Screw	Slot Screw	8	40.64	TL313V-08PGS	20	101.6	TL313V-20PGS		
Join	Interlocking	9	45.72	TL313V-09PGS	21	106.68	TL313V-21PGS		
Colour	Green or Black	10	50.8	TL313V-10PGS	22	111.76	TL313V-22PGS		
Current	10A	11	55.88	TL313V-11PGS	23	116.84	TL313V-23PGS		
Voltage	300V	12	60.96	TL313V-12PGS	24	121.92	TL313V-24PGS		
Approval Bodies		13	66.04	TL313V-13PGS					

TL324V-xxPGS

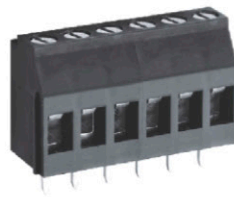
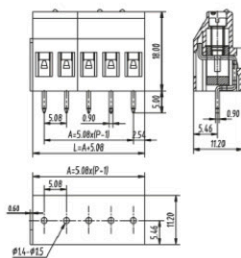

2-24 Pole Screw Rising Clamp
Vertical 5.08mm pitch 25A 300V

		N° of Poles	Pole Length (mm)	Product Code	N° of Poles	Pole Length (mm)	Product Code
Pitch (mm)	5.08	2	10.16	TL324V-02PGS	14	71.12	TL324V-14PGS
Wire Size AWG	Min: 28 / Max: 10	3	15.24	TL324V-03PGS	15	76.2	TL324V-15PGS
Wire Size (mm²)	Max: 6	4	20.32	TL324V-04PGS	16	81.28	TL324V-16PGS
PCB Hole Ø	1.4-1.5	5	25.4	TL324V-05PGS	17	86.36	TL324V-17PGS
Orientation	Vertical	6	30.48	TL324V-06PGS	18	91.44	TL324V-18PGS
Mount Type	Vertical	7	35.56	TL324V-07PGS	19	96.52	TL324V-19PGS
Screw	Slot Screw	8	40.64	TL324V-08PGS	20	101.6	TL324V-20PGS
Join	Interlocking	9	45.72	TL324V-09PGS	21	106.68	TL324V-21PGS
Colour	Green or Black	10	50.8	TL324V-10PGS	22	111.76	TL324V-22PGS
Current	25A	11	55.88	TL324V-11PGS	23	116.84	TL324V-23PGS
Voltage	300V	12	60.96	TL324V-12PGS	24	121.92	TL324V-24PGS
Approval Bodies		13	66.04	TL324V-13PGS			

TL324V-xxPKS

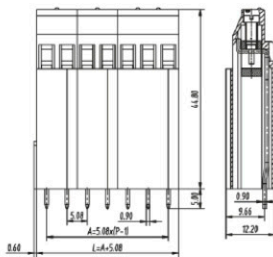

2-24 Pole Screw Rising Clamp
Vertical 5.08mm pitch 25A 300V

		N° of Poles	Pole Length (mm)	Product Code	N° of Poles	Pole Length (mm)	Product Code
Pitch (mm)	5.08	2	10.16	TL324V-02PKS	14	71.12	TL324V-14PKS
Wire Size AWG	Min: 28 / Max: 10	3	15.24	TL324V-03PKS	15	76.2	TL324V-15PKS
Wire Size (mm²)	Max: 6	4	20.32	TL324V-04PKS	16	81.28	TL324V-16PKS
PCB Hole Ø	1.4-1.5	5	25.4	TL324V-05PKS	17	86.36	TL324V-17PKS
Orientation	Vertical	6	30.48	TL324V-06PKS	18	91.44	TL324V-18PKS
Mount Type	Vertical	7	35.56	TL324V-07PKS	19	96.52	TL324V-19PKS
Screw	Slot Screw	8	40.64	TL324V-08PKS	20	101.6	TL324V-20PKS
Join	Interlocking	9	45.72	TL324V-09PKS	21	106.68	TL324V-21PKS
Colour	Green or Black	10	50.8	TL324V-10PKS	22	111.76	TL324V-22PKS
Current	25A	11	55.88	TL324V-11PKS	23	116.84	TL324V-23PKS
Voltage	300V	12	60.96	TL324V-12PKS	24	121.92	TL324V-24PKS
Approval Bodies		13	66.04	TL324V-13PKS			

TL324VM-xxPKS

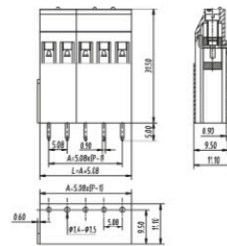

2-24 Pole Screw Rising Clamp
Vertical 5.08mm pitch

		N° of Poles	Pole Length (mm)	Product Code	N° of Poles	Pole Length (mm)	Product Code
Pitch (mm)	5.08	2	10.16	TL324VM-02PKS	14	71.12	TL324VM-14PKS
Wire Size AWG	Min: 28 / Max: 10	3	15.24	TL324VM-03PKS	15	76.2	TL324VM-15PKS
Wire Size (mm²)	Max: 6	4	20.32	TL324VM-04PKS	16	81.28	TL324VM-16PKS
PCB Hole Ø	1.4-1.5	5	25.4	TL324VM-05PKS	17	86.36	TL324VM-17PKS
Orientation	Vertical	6	30.48	TL324VM-06PKS	18	91.44	TL324VM-18PKS
Mount Type	Vertical	7	35.56	TL324VM-07PKS	19	96.52	TL324VM-19PKS
Screw	Slot Screw	8	40.64	TL324VM-08PKS	20	101.6	TL324VM-20PKS
Join	Interlocking	9	45.72	TL324VM-09PKS	21	106.68	TL324VM-21PKS
Colour	Green or Black	10	50.8	TL324VM-10PKS	22	111.76	TL324VM-22PKS
Current	25A	11	55.88	TL324VM-11PKS	23	116.84	TL324VM-23PKS
Voltage	300V	12	60.96	TL324VM-12PKS	24	121.92	TL324VM-24PKS
Approval Bodies		13	66.04	TL324VM-13PKS			

*xx = number of poles

PCB TERMINAL BLOCKS RISING CLAMP - SINGLE ROW

TL306R-xxPGS

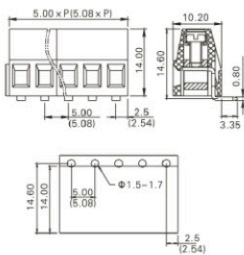

2-24 Pole Screw Rising Clamp Wave - through hole Horizontal 5.08mm pitch

		N° of Poles	Pole Length (mm)	Product Code	N° of Poles	Pole Length (mm)	Product Code
Pitch (mm)	5.08	2	10.16	TL306R-02PGS	14	71.12	TL306R-14PGS
Wire Size AWG	Min: 24 / Max: 12	3	15.24	TL306R-03PGS	15	76.2	TL306R-15PGS
Wire Size (mm ²)	Min: 0.5 / Max: 2.5	4	20.32	TL306R-04PGS	16	81.28	TL306R-16PGS
PCB Hole Ø	1.5-1.7	5	25.4	TL306R-05PGS	17	86.36	TL306R-17PGS
Orientation	Horizontal	6	30.48	TL306R-06PGS	18	91.44	TL306R-18PGS
Mount Type	Wave - Through Hole	7	35.56	TL306R-07PGS	19	96.52	TL306R-19PGS
Screw	Slot Screw	8	40.64	TL306R-08PGS	20	101.6	TL306R-20PGS
Join	Interlocking	9	45.72	TL306R-09PGS	21	106.68	TL306R-21PGS
Colour	Green or Black	10	50.8	TL306R-10PGS	22	111.76	TL306R-22PGS
Current	20A (UL) / 12A (VDE)	11	55.88	TL306R-11PGS	23	116.84	TL306R-23PGS
Voltage	300V (UL) / 250V (VDE)	12	60.96	TL306R-12PGS	24	121.92	TL306R-24PGS
Approval Bodies		13	66.04	TL306R-13PGS			

TL306V-xxPGS

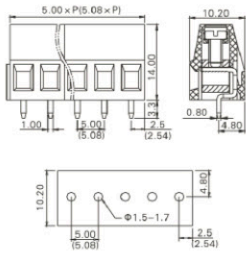

2-24 Pole Screw Rising Clamp Wave - through hole Vertical 5.08mm pitch

		N° of Poles	Pole Length (mm)	Product Code	N° of Poles	Pole Length (mm)	Product Code
Pitch (mm)	5.08	2	10.16	TL306V-02PGS	14	71.12	TL306V-14PGS
Wire Size AWG	Min: 24 / Max: 12	3	15.24	TL306V-03PGS	15	76.2	TL306V-15PGS
Wire Size (mm ²)	Min: 0.5 / Max: 2.5	4	20.32	TL306V-04PGS	16	81.28	TL306V-16PGS
PCB Hole Ø	1.5-1.7	5	25.4	TL306V-05PGS	17	86.36	TL306V-17PGS
Orientation	Vertical	6	30.48	TL306V-06PGS	18	91.44	TL306V-18PGS
Mount Type	Wave - Through Hole	7	35.56	TL306V-07PGS	19	96.52	TL306V-19PGS
Screw	Slot Screw	8	40.64	TL306V-08PGS	20	101.6	TL306V-20PGS
Join	Interlocking	9	45.72	TL306V-09PGS	21	106.68	TL306V-21PGS
Colour	Green or Black	10	50.8	TL306V-10PGS	22	111.76	TL306V-22PGS
Current	20A (UL) / 12A (VDE)	11	55.88	TL306V-11PGS	23	116.84	TL306V-23PGS
Voltage	300V (UL) / 250V (VDE)	12	60.96	TL306V-12PGS	24	121.92	TL306V-24PGS
Approval Bodies		13	66.04	TL306V-13PGS			

TL308V-xxPGS

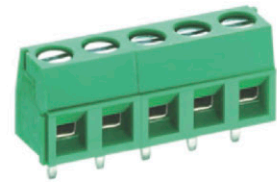
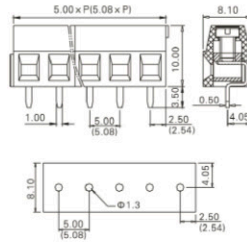

2-24 Pole Screw Rising Clamp Wave - through hole Vertical 5.08mm pitch

		N° of Poles	Pole Length (mm)	Product Code	N° of Poles	Pole Length (mm)	Product Code
Pitch (mm)	5.08	2	10.16	TL308V-02PGS	14	71.12	TL308V-14PGS
Wire Size AWG	Min: 26 / Max: 16	3	15.24	TL308V-03PGS	15	76.2	TL308V-15PGS
Wire Size (mm ²)	Min: 0.2 / Max: 1.5	4	20.32	TL308V-04PGS	16	81.28	TL308V-16PGS
PCB Hole Ø	1.3	5	25.4	TL308V-05PGS	17	86.36	TL308V-17PGS
Orientation	Vertical	6	30.48	TL308V-06PGS	18	91.44	TL308V-18PGS
Mount Type	Wave - Through Hole	7	35.56	TL308V-07PGS	19	96.52	TL308V-19PGS
Screw	Slot Screw	8	40.64	TL308V-08PGS	20	101.6	TL308V-20PGS
Join	Interlocking	9	45.72	TL308V-09PGS	21	106.68	TL308V-21PGS
Colour	Green or Black	10	50.8	TL308V-10PGS	22	111.76	TL308V-22PGS
Current	10A (UL)	11	55.88	TL308V-11PGS	23	116.84	TL308V-23PGS
Voltage	150V (UL)	12	60.96	TL308V-12PGS	24	121.92	TL308V-24PGS
Approval Bodies		13	66.04	TL308V-13PGS			

TL312V-xxPGS

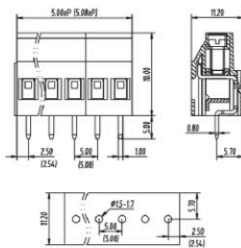

2-24 Pole Screw Rising Clamp Wave - through hole Vertical 5.08mm pitch

		N° of Poles	Pole Length (mm)	Product Code	N° of Poles	Pole Length (mm)	Product Code
Pitch (mm)	5.08	2	10.16	TL312V-02PGS	14	71.12	TL312V-14PGS
Wire Size AWG	Min: 24 / Max: 12	3	15.24	TL312V-03PGS	15	76.2	TL312V-15PGS
Wire Size (mm²)	Min: 0.34 / Max: 4	4	20.32	TL312V-04PGS	16	81.28	TL312V-16PGS
PCB Hole Ø	1.5-1.7	5	25.4	TL312V-05PGS	17	86.36	TL312V-17PGS
Orientation	Vertical	6	30.48	TL312V-06PGS	18	91.44	TL312V-18PGS
Mount Type	Wave - Through Hole	7	35.56	TL312V-07PGS	19	96.52	TL312V-19PGS
Screw	Slot Screw	8	40.64	TL312V-08PGS	20	101.6	TL312V-20PGS
Join	Interlocking	9	45.72	TL312V-09PGS	21	106.68	TL312V-21PGS
Colour	Green or Black	10	50.8	TL312V-10PGS	22	111.76	TL312V-22PGS
Current	20A (UL) / 20A (VDE)	11	55.88	TL312V-11PGS	23	116.84	TL312V-23PGS
Voltage	300V (UL) / 300V (VDE)	12	60.96	TL312V-12PGS	24	121.92	TL312V-24PGS
Approval Bodies		13	66.04	TL312V-13PGS			

TL901V-xxPGS

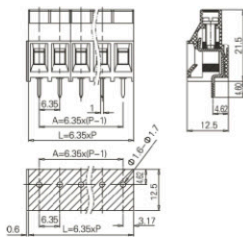

2-24 Pole Screw Rising Clamp Vertical 6.35mm pitch

		N° of Poles	Pole Length (mm)	Product Code	N° of Poles	Pole Length (mm)	Product Code
Pitch (mm)	6.35	2	12.7	TL901V-02PGS	14	88.9	TL901V-14PGS
Wire Size AWG	Min: 26 / Max: 10	3	19.05	TL901V-03PGS	15	95.25	TL901V-15PGS
Wire Size (mm²)	Min: 0.2 / Max: 6	4	25.4	TL901V-04PGS	16	101.6	TL901V-16PGS
PCB Hole Ø	1.6-1.7	5	31.75	TL901V-05PGS	17	107.95	TL901V-17PGS
Orientation	Vertical	6	38.1	TL901V-06PGS	18	114.3	TL901V-18PGS
Mount Type	Vertical	7	44.45	TL901V-07PGS	19	120.65	TL901V-19PGS
Screw	Slot Screw	8	50.8	TL901V-08PGS	20	127	TL901V-20PGS
Join	Interlocking	9	57.15	TL901V-09PGS	21	133.35	TL901V-21PGS
Colour	Green or Black	10	63.5	TL901V-10PGS	22	139.7	TL901V-22PGS
Current	30A (UL) / 32A (VDE)	11	69.85	TL901V-11PGS	23	146.05	TL901V-23PGS
Voltage	600V (UL) / 450V (VDE)	12	76.2	TL901V-12PGS	24	152.4	TL901V-24PGS
Approval Bodies		13	82.55	TL901V-13PGS			

TL420RA-xxPGS

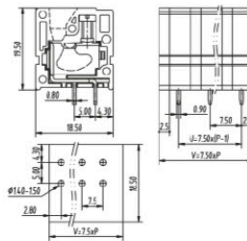

2-24 Pole Screw Rising Clamp Horizontal 7.5mm pitch

		N° of Poles	Pole Length (mm)	Product Code	N° of Poles	Pole Length (mm)	Product Code
Pitch (mm)	7.5	2	15	TL420RA-02PGS	14	105	TL420RA-14PGS
Wire Size AWG	Min: 28 / Max: 12	3	22.5	TL420RA-03PGS	15	112.5	TL420RA-15PGS
Wire Size (mm²)	Max: 4	4	30	TL420RA-04PGS	16	120	TL420RA-16PGS
PCB Hole Ø	1.4-1.5	5	37.5	TL420RA-05PGS	17	127.5	TL420RA-17PGS
Orientation	Horizontal	6	45	TL420RA-06PGS	18	135	TL420RA-18PGS
Mount Type	Horizontal	7	52.5	TL420RA-07PGS	19	142.5	TL420RA-19PGS
Screw	Slot Screw	8	60	TL420RA-08PGS	20	150	TL420RA-20PGS
Join	End Stackable	9	67.5	TL420RA-09PGS	21	157.5	TL420RA-21PGS
Colour	Green or Black	10	75	TL420RA-10PGS	22	165	TL420RA-22PGS
Current	20A (UL)	11	82.5	TL420RA-11PGS	23	172.5	TL420RA-23PGS
Voltage	300V (UL)	12	90	TL420RA-12PGS	24	180	TL420RA-24PGS
Approval Bodies		13	97.5	TL420RA-13PGS			

*xx = number of poles

PCB TERMINAL BLOCKS RISING CLAMP - SINGLE ROW

TL420VA-xxPGS

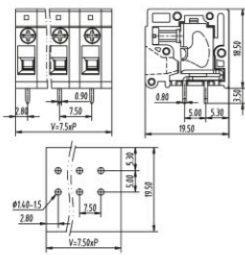

2-24 Pole Screw Rising Clamp
Vertical 7.5mm pitch

		N° of Poles	Pole Length (mm)	Product Code	N° of Poles	Pole Length (mm)	Product Code
Pitch (mm)	7.5	2	15	TL420VA-02PGS	14	105	TL420VA-14PGS
Wire Size AWG	Min: 28 / Max: 12	3	22.5	TL420VA-03PGS	15	112.5	TL420VA-15PGS
Wire Size (mm ²)	Max: 4	4	30	TL420VA-04PGS	16	120	TL420VA-16PGS
PCB Hole Ø	1.4-1.5	5	37.5	TL420VA-05PGS	17	127.5	TL420VA-17PGS
Orientation	Vertical	6	45	TL420VA-06PGS	18	135	TL420VA-18PGS
Mount Type	Vertical	7	52.5	TL420VA-07PGS	19	142.5	TL420VA-19PGS
Screw	Slot Screw	8	60	TL420VA-08PGS	20	150	TL420VA-20PGS
Join	End Stackable	9	67.5	TL420VA-09PGS	21	157.5	TL420VA-21PGS
Colour	Green or Black	10	75	TL420VA-10PGS	22	165	TL420VA-22PGS
Current	20A (UL)	11	82.5	TL420VA-11PGS	23	172.5	TL420VA-23PGS
Voltage	300V (UL)	12	90	TL420VA-12PGS	24	180	TL420VA-24PGS
Approval Bodies		13	97.5	TL420VA-13PGS			

TL414R-xxPGS

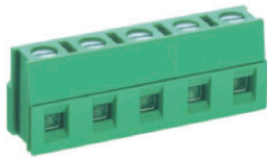
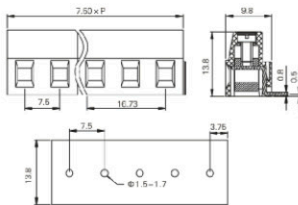

2-24 Pole Screw Rising Clamp
Horizontal 7.5mm pitch

		N° of Poles	Pole Length (mm)	Product Code	N° of Poles	Pole Length (mm)	Product Code
Pitch (mm)	7.5	2	15	TL414R-02PGS	14	105	TL414R-14PGS
Wire Size AWG	Min: 22 / Max: 12	3	22.5	TL414R-03PGS	15	112.5	TL414R-15PGS
Wire Size (mm ²)	Min: 0.34 / Max: 4	4	30	TL414R-04PGS	16	120	TL414R-16PGS
PCB Hole Ø	1.5-1.7	5	37.5	TL414R-05PGS	17	127.5	TL414R-17PGS
Orientation	Horizontal	6	45	TL414R-06PGS	18	135	TL414R-18PGS
Mount Type	Horizontal	7	52.5	TL414R-07PGS	19	142.5	TL414R-19PGS
Screw	Slot Screw	8	60	TL414R-08PGS	20	150	TL414R-20PGS
Join	Interlocking	9	67.5	TL414R-09PGS	21	157.5	TL414R-21PGS
Colour	Green or Black	10	75	TL414R-10PGS	22	165	TL414R-22PGS
Current	20A (UL)	11	82.5	TL414R-11PGS	23	172.5	TL414R-23PGS
Voltage	300V (UL)	12	90	TL414R-12PGS	24	180	TL414R-24PGS
Approval Bodies		13	97.5	TL414R-13PGS			

TL401V-xxPGS

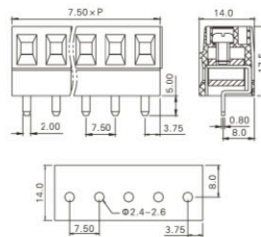

2-24 Pole Screw Rising Clamp
Vertical 7.5mm pitch

		N° of Poles	Pole Length (mm)	Product Code	N° of Poles	Pole Length (mm)	Product Code
Pitch (mm)	7.5	2	15	TL401V-02PGS	14	105	TL401V-14PGS
Wire Size AWG	Min: 24 / Max: 12	3	22.5	TL401V-03PGS	15	112.5	TL401V-15PGS
Wire Size (mm ²)	Min: 0.2 / Max: 4	4	30	TL401V-04PGS	16	120	TL401V-16PGS
PCB Hole Ø	2.4-2.6	5	37.5	TL401V-05PGS	17	127.5	TL401V-17PGS
Orientation	Vertical	6	45	TL401V-06PGS	18	135	TL401V-18PGS
Mount Type	Vertical	7	52.5	TL401V-07PGS	19	142.5	TL401V-19PGS
Screw	Slot Screw	8	60	TL401V-08PGS	20	150	TL401V-20PGS
Join	Interlocking	9	67.5	TL401V-09PGS	21	157.5	TL401V-21PGS
Colour	Green or Black	10	75	TL401V-10PGS	22	165	TL401V-22PGS
Current	20A (UL)	11	82.5	TL401V-11PGS	23	172.5	TL401V-23PGS
Voltage	300V (UL)	12	90	TL401V-12PGS	24	180	TL401V-24PGS
Approval Bodies		13	97.5	TL401V-13PGS			

TL403V-xxPGS

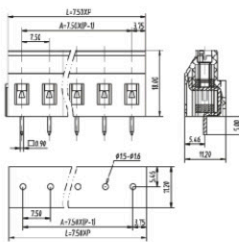

2-24 Pole Screw Rising Clamp
Vertical 7.5mm pitch

		N° of Poles	Pole Length (mm)	Product Code	N° of Poles	Pole Length (mm)	Product Code
Pitch (mm)	7.5	2	15	TL403V-02PGS	14	105	TL403V-14PGS
Wire Size AWG	Min: 22 / Max: 12	3	22.5	TL403V-03PGS	15	112.5	TL403V-15PGS
Wire Size (mm²)	Min: 0.34 / Max: 4	4	30	TL403V-04PGS	16	120	TL403V-16PGS
PCB Hole Ø	1.5-1.7	5	37.5	TL403V-05PGS	17	127.5	TL403V-17PGS
Orientation	Vertical	6	45	TL403V-06PGS	18	135	TL403V-18PGS
Mount Type	Vertical	7	52.5	TL403V-07PGS	19	142.5	TL403V-19PGS
Screw	Slot Screw	8	60	TL403V-08PGS	20	150	TL403V-20PGS
Join	Interlocking	9	67.5	TL403V-09PGS	21	157.5	TL403V-21PGS
Colour	Green or Black	10	75	TL403V-10PGS	22	165	TL403V-22PGS
Current	20A (UL)	11	82.5	TL403V-11PGS	23	172.5	TL403V-23PGS
Voltage	300V (UL)	12	90	TL403V-12PGS	24	180	TL403V-24PGS
Approval Bodies		13	97.5	TL403V-13PGS			

TL414V-xxPGS

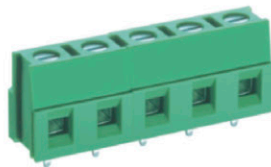
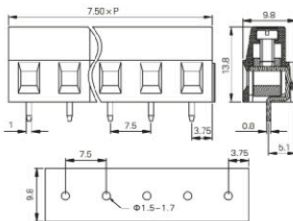

2-24 Pole Screw Rising Clamp
Vertical 7.5mm pitch

		N° of Poles	Pole Length (mm)	Product Code	N° of Poles	Pole Length (mm)	Product Code
Pitch (mm)	7.5	2	15	TL414V-02PGS	14	105	TL414V-14PGS
Wire Size AWG	Min: 22 / Max: 12	3	22.5	TL414V-03PGS	15	112.5	TL414V-15PGS
Wire Size (mm²)	Min: 0.34 / Max: 4	4	30	TL414V-04PGS	16	120	TL414V-16PGS
PCB Hole Ø	1.5-1.7	5	37.5	TL414V-05PGS	17	127.5	TL414V-17PGS
Orientation	Vertical	6	45	TL414V-06PGS	18	135	TL414V-18PGS
Mount Type	Vertical	7	52.5	TL414V-07PGS	19	142.5	TL414V-19PGS
Screw	Slot Screw	8	60	TL414V-08PGS	20	150	TL414V-20PGS
Join	Interlocking	9	67.5	TL414V-09PGS	21	157.5	TL414V-21PGS
Colour	Green or Black	10	75	TL414V-10PGS	22	165	TL414V-22PGS
Current	20A (UL)	11	82.5	TL414V-11PGS	23	172.5	TL414V-23PGS
Voltage	300V (UL)	12	90	TL414V-12PGS	24	180	TL414V-24PGS
Approval Bodies		13	97.5	TL414V-13PGS			

TL402R-xxPGS

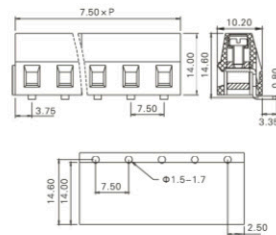

2-24 Pole Screw Rising Clamp Wave -
through hole Horizontal 7.5mm pitch

		N° of Poles	Pole Length (mm)	Product Code	N° of Poles	Pole Length (mm)	Product Code
Pitch (mm)	7.5	2	15	TL402R-02PGS	14	105	TL402R-14PGS
Wire Size AWG	Min: 24 / Max: 12	3	22.5	TL402R-03PGS	15	112.5	TL402R-15PGS
Wire Size (mm²)	Min: 0.5 / Max: 2.5	4	30	TL402R-04PGS	16	120	TL402R-16PGS
PCB Hole Ø	1.5-1.7	5	37.5	TL402R-05PGS	17	127.5	TL402R-17PGS
Orientation	Horizontal	6	45	TL402R-06PGS	18	135	TL402R-18PGS
Mount Type	Wave - Through hole	7	52.5	TL402R-07PGS	19	142.5	TL402R-19PGS
Screw	Slot Screw	8	60	TL402R-08PGS	20	150	TL402R-20PGS
Join	Interlocking	9	67.5	TL402R-09PGS	21	157.5	TL402R-21PGS
Colour	Green or Black	10	75	TL402R-10PGS	22	165	TL402R-22PGS
Current	20A (UL) / 12A (VDE)	11	82.5	TL402R-11PGS	23	172.5	TL402R-23PGS
Voltage	300V (UL) / 250V (VDE)	12	90	TL402R-12PGS	24	180	TL402R-24PGS
Approval Bodies		13	97.5	TL402R-13PGS			

*xx = number of poles

PCB TERMINAL BLOCKS RISING CLAMP - SINGLE ROW

TL402V-xxPGS

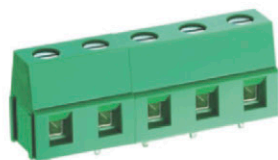
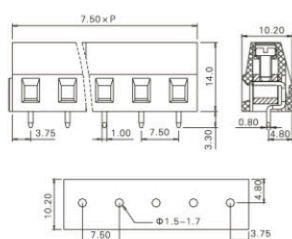

2-24 Pole Screw Rising Clamp Wave - through hole Vertical 7.5mm pitch

		N° of Poles	Pole Length (mm)	Product Code	N° of Poles	Pole Length (mm)	Product Code
Pitch (mm)	7.5	2	15	TL402V-02PGS	14	105	TL402V-14PGS
Wire Size AWG	Min: 24 / Max: 12	3	22.5	TL402V-03PGS	15	112.5	TL402V-15PGS
Wire Size (mm ²)	Min: 0.5 / Max: 2.5	4	30	TL402V-04PGS	16	120	TL402V-16PGS
PCB Hole Ø	1.5-1.7	5	37.5	TL402V-05PGS	17	127.5	TL402V-17PGS
Orientation	Vertical	6	45	TL402V-06PGS	18	135	TL402V-18PGS
Mount Type	Wave - Through hole	7	52.5	TL402V-07PGS	19	142.5	TL402V-19PGS
Screw	Slot Screw	8	60	TL402V-08PGS	20	150	TL402V-20PGS
Join	Interlocking	9	67.5	TL402V-09PGS	21	157.5	TL402V-21PGS
Colour	Green or Black	10	75	TL402V-10PGS	22	165	TL402V-22PGS
Current	20A (UL) / 12A (VDE)	11	82.5	TL402V-11PGS	23	172.5	TL402V-23PGS
Voltage	300V (UL) / 250V (VDE)	12	90	TL402V-12PGS	24	180	TL402V-24PGS
Approval Bodies		13	97.5	TL402V-13PGS			

TL606V-xxPGS

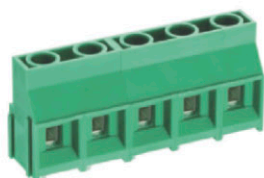
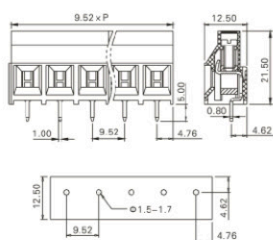

2-24 Pole Screw Rising Clamp Wave - through hole Vertical 9.52mm pitch

		N° of Poles	Pole Length (mm)	Product Code	N° of Poles	Pole Length (mm)	Product Code
Pitch (mm)	9.52	2	19.04	TL606V-02PGS	14	133.28	TL606V-14PGS
Wire Size AWG	Min: 26 / Max: 10	3	28.56	TL606V-03PGS	15	142.8	TL606V-15PGS
Wire Size (mm ²)	Min: 0.2 / Max: 6	4	38.08	TL606V-04PGS	16	152.32	TL606V-16PGS
PCB Hole Ø	1.5-1.7	5	47.6	TL606V-05PGS	17	161.84	TL606V-17PGS
Orientation	Vertical	6	57.12	TL606V-06PGS	18	171.36	TL606V-18PGS
Mount Type	Wave - Through Hole	7	66.64	TL606V-07PGS	19	180.88	TL606V-19PGS
Screw	Slot Screw	8	76.16	TL606V-08PGS	20	190.4	TL606V-20PGS
Join	Interlocking	9	85.68	TL606V-09PGS	21	199.92	TL606V-21PGS
Colour	Green or Black	10	95.2	TL606V-10PGS	22	209.44	TL606V-22PGS
Current	30A (UL)	11	104.72	TL606V-11PGS	23	218.96	TL606V-23PGS
Voltage	300V (UL)	12	114.24	TL606V-12PGS	24	228.48	TL606V-24PGS
Approval Bodies		13	123.76	TL606V-13PGS			

TL207-xxP5GS

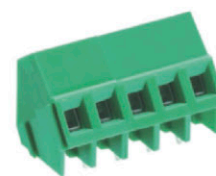
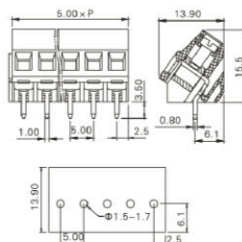

2-12 Pole Screw Rising Clamp Wave - through hole 35 degree 10mm pitch

		N° of Poles	Pole Length (mm)	Product Code	N° of Poles	Pole Length (mm)	Product Code
Pitch (mm)	10	2	15	TL207-02P5GS			
Wire Size AWG	Min: 24 / Max: 12	3	25	TL207-03P5GS			
Wire Size (mm ²)	Min: 0.2 / Max: 4	4	35	TL207-04P5GS			
PCB Hole Ø	1.5-1.7	5	45	TL207-05P5GS			
Orientation	35 degree	6	55	TL207-06P5GS			
Mount Type	Wave - Through Hole	7	65	TL207-07P5GS			
Screw	Slot Screw	8	75	TL207-08P5GS			
Join	Interlocking	9	85	TL207-09P5GS			
Colour	Green or Black	10	95	TL207-10P5GS			
Current	12A (UL)	11	105	TL207-11P5GS			
Voltage	250V (UL)	12	115	TL207-12P5GS			
Approval Bodies							

TL204-xxP5KS

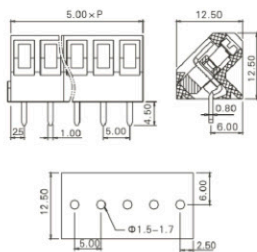

2-12 Pole Screw Rising Clamp Wave - through hole 45 degree 10mm pitch

		N° of Poles	Pole Length (mm)	Product Code	N° of Poles	Pole Length (mm)	Product Code
Pitch (mm)	10	2	15	TL204-02P5KS			
Wire Size AWG	Min: 26 / Max: 12	3	25	TL204-03P5KS			
Wire Size (mm ²)	Min: 0.2 / Max: 2.5	4	35	TL204-04P5KS			
PCB Hole Ø	1.5-1.7	5	45	TL204-05P5KS			
Orientation	45 degree	6	55	TL204-06P5KS			
Mount Type	Wave - Through Hole	7	65	TL204-07P5KS			
Screw	Slot Screw	8	75	TL204-08P5KS			
Join	Interlocking	9	85	TL204-09P5KS			
Colour	Green or Black	10	95	TL204-10P5KS			
Current	16A (UL) / 16A (VDE)	11	105	TL204-11P5KS			
Voltage	250V (UL) / 130V (VDE)	12	115	TL204-12P5KS			
Approval Bodies							

TL206R-xxP5GS

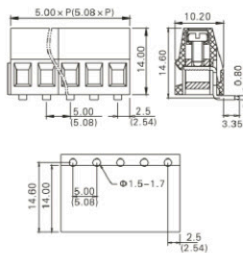

2-12 Pole Screw Rising Clamp Wave - through hole Horizontal 10mm pitch

		N° of Poles	Pole Length (mm)	Product Code	N° of Poles	Pole Length (mm)	Product Code
Pitch (mm)	10	2	15	TL206R-02P5GS			
Wire Size AWG	Min: 24 / Max: 12	3	25	TL206R-03P5GS			
Wire Size (mm ²)	Min: 0.5 / Max: 2.5	4	35	TL206R-04P5GS			
PCB Hole Ø	1.5-1.7	5	45	TL206R-05P5GS			
Orientation	Horizontal	6	55	TL206R-06P5GS			
Mount Type	Wave - Through Hole	7	65	TL206R-07P5GS			
Screw	Slot Screw	8	75	TL206R-08P5GS			
Join	Interlocking	9	85	TL206R-09P5GS			
Colour	Green or Black	10	95	TL206R-10P5GS			
Current	20A (UL) / 12A (VDE)	11	105	TL206R-11P5GS			
Voltage	300V (UL) / 250V (VDE)	12	115	TL206R-12P5GS			
Approval Bodies							

TL206V-xxP5GS

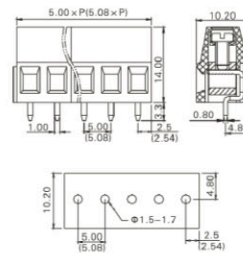

2-12 Pole Screw Rising Clamp Wave - through hole Vertical 10mm pitch

		N° of Poles	Pole Length (mm)	Product Code	N° of Poles	Pole Length (mm)	Product Code
Pitch (mm)	10	2	15	TL206VT-02P5GS			
Wire Size AWG	Min: 24 / Max: 12	3	25	TL206VT-03P5GS			
Wire Size (mm ²)	Min: 0.5 / Max: 2.5	4	35	TL206VT-04P5GS			
PCB Hole Ø	1.5-1.7	5	45	TL206VT-05P5GS			
Orientation	Vertical	6	55	TL206VT-06P5GS			
Mount Type	Wave - Through Hole	7	65	TL206VT-07P5GS			
Screw	Slot Screw	8	75	TL206VT-08P5GS			
Join	Interlocking	9	85	TL206VT-09P5GS			
Colour	Green or Black	10	95	TL206VT-10P5GS			
Current	20A (UL) / 12A (VDE)	11	105	TL206VT-11P5GS			
Voltage	300V (UL) / 250V (VDE)	12	115	TL206VT-12P5GS			
Approval Bodies							

*xx = number of poles

PCB TERMINAL BLOCKS RISING CLAMP - SINGLE ROW

TL206VT-xxP5GS

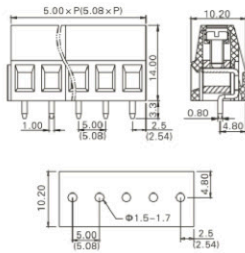

2-12 Pole Screw Rising Clamp Wave - through hole Vertical 10mm pitch

		N° of Poles	Pole Length (mm)	Product Code	N° of Poles	Pole Length (mm)	Product Code
Pitch (mm)	10	2	15	TL206VT-02P5GS			
Wire Size AWG	Min: 24 / Max: 12	3	25	TL206VT-03P5GS			
Wire Size (mm ²)	Min: 0.5 / Max: 2.5	4	35	TL206VT-04P5GS			
PCB Hole Ø	1.5-1.7	5	45	TL206VT-05P5GS			
Orientation	Vertical	6	55	TL206VT-06P5GS			
Mount Type	Wave - Through Hole	7	65	TL206VT-07P5GS			
Screw	Slot Screw	8	75	TL206VT-08P5GS			
Join	Interlocking	9	85	TL206VT-09P5GS			
Colour	Green or Black	10	95	TL206VT-10P5GS			
Current	20A (UL) / 12A (VDE)	11	105	TL206VT-11P5GS			
Voltage	300V (UL) / 250V (VDE)	12	115	TL206VT-12P5GS			
Approval Bodies							

TL208V-xxP5GS

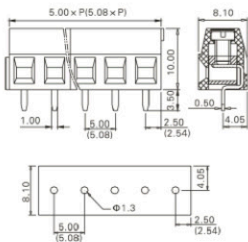

2-12 Pole Screw Rising Clamp Wave - through hole Vertical 10mm pitch

		N° of Poles	Pole Length (mm)	Product Code	N° of Poles	Pole Length (mm)	Product Code
Pitch (mm)	10	2	15	TL208V-02P5GS			
Wire Size AWG	Min: 26 / Max: 16	3	25	TL208V-03P5GS			
Wire Size (mm ²)	Min: 0.2 / Max: 1.5	4	35	TL208V-04P5GS			
PCB Hole Ø	1.3	5	45	TL208V-05P5GS			
Orientation	Vertical	6	55	TL208V-06P5GS			
Mount Type	Wave - Through Hole	7	65	TL208V-07P5GS			
Screw	Slot Screw	8	75	TL208V-08P5GS			
Join	Interlocking	9	85	TL208V-09P5GS			
Colour	Green or Black	10	95	TL208V-10P5GS			
Current	10A (UL)	11	105	TL208V-11P5GS			
Voltage	150V (UL)	12	115	TL208V-12P5GS			
Approval Bodies							

TL208VT-xxP5GS

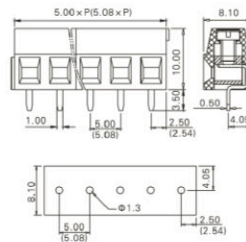

2-12 Pole Screw Rising Clamp Wave - through hole Vertical 10mm pitch

		N° of Poles	Pole Length (mm)	Product Code	N° of Poles	Pole Length (mm)	Product Code
Pitch (mm)	10	2	15	TL208VT-02P5GS			
Wire Size AWG	Min: 26 / Max: 16	3	25	TL208VT-03P5GS			
Wire Size (mm ²)	Min: 0.2 / Max: 1.5	4	35	TL208VT-04P5GS			
PCB Hole Ø	1.3	5	45	TL208VT-05P5GS			
Orientation	Vertical	6	55	TL208VT-06P5GS			
Mount Type	Wave - Through Hole	7	65	TL208VT-07P5GS			
Screw	Slot Screw	8	75	TL208VT-08P5GS			
Join	Interlocking	9	85	TL208VT-09P5GS			
Colour	Green or Black	10	95	TL208VT-10P5GS			
Current	10A (UL)	11	105	TL208VT-11P5GS			
Voltage	150V (UL)	12	115	TL208VT-12P5GS			
Approval Bodies							

TL212V-xxP5GS

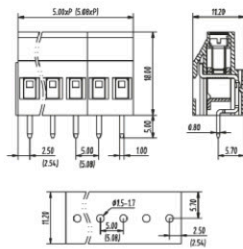

2-12 Pole Screw Rising Clamp Wave - through hole Vertical 10mm pitch

		N° of Poles	Pole Length (mm)	Product Code	N° of Poles	Pole Length (mm)	Product Code
Pitch (mm)	10	2	15	TL212V-02P5GS			
Wire Size AWG	Min: 24 / Max: 12	3	25	TL212V-03P5GS			
Wire Size (mm ²)	Min: 0.34 / Max: 4	4	35	TL212V-04P5GS			
PCB Hole Ø	1.5-1.7	5	45	TL212V-05P5GS			
Orientation	Vertical	6	55	TL212V-06P5GS			
Mount Type	Wave - Through Hole	7	65	TL212V-07P5GS			
Screw	Slot Screw	8	75	TL212V-08P5GS			
Join	Interlocking	9	85	TL212V-09P5GS			
Colour	Green or Black	10	95	TL212V-10P5GS			
Current	20A (UL) / 20A (VDE)	11	105	TL212V-11P5GS			
Voltage	300V (UL) / 300V (VDE)	12	115	TL212V-12P5GS			
Approval Bodies							

TL306R-xxP5GS

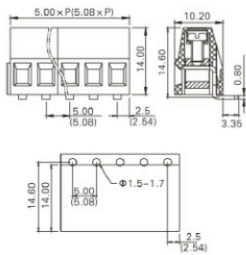

2-12 Pole Screw Rising Clamp Wave - through hole Horizontal 10.16mm pitch

		N° of Poles	Pole Length (mm)	Product Code	N° of Poles	Pole Length (mm)	Product Code
Pitch (mm)	10.16	2	15.24	TL306R-02P5GS			
Wire Size AWG	Min: 24 / Max: 12	3	25.4	TL306R-03P5GS			
Wire Size (mm ²)	Min: 0.5 / Max: 2.5	4	35.56	TL306R-04P5GS			
PCB Hole Ø	1.5-1.7	5	45.72	TL306R-05P5GS			
Orientation	Horizontal	6	55.88	TL306R-06P5GS			
Mount Type	Wave - Through Hole	7	66.04	TL306R-07P5GS			
Screw	Slot Screw	8	76.2	TL306R-08P5GS			
Join	Interlocking	9	86.36	TL306R-09P5GS			
Colour	Green or Black	10	96.52	TL306R-10P5GS			
Current	20A (UL) / 12A (VDE)	11	106.68	TL306R-11P5GS			
Voltage	300V (UL) / 250V (VDE)	12	116.84	TL306R-12P5GS			
Approval Bodies							

TL306V-xxP5GS

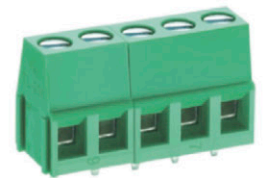
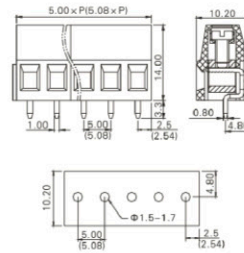

2-12 Pole Screw Rising Clamp Wave - through hole Vertical 10.16mm pitch

		N° of Poles	Pole Length (mm)	Product Code	N° of Poles	Pole Length (mm)	Product Code
Pitch (mm)	10.16	2	15.24	TL306V-02P5GS			
Wire Size AWG	Min: 24 / Max: 12	3	25.4	TL306V-03P5GS			
Wire Size (mm ²)	Min: 0.5 / Max: 2.5	4	35.56	TL306V-04P5GS			
PCB Hole Ø	1.5-1.7	5	45.72	TL306V-05P5GS			
Orientation	Vertical	6	55.88	TL306V-06P5GS			
Mount Type	Wave - Through Hole	7	66.04	TL306V-07P5GS			
Screw	Slot Screw	8	76.2	TL306V-08P5GS			
Join	Interlocking	9	86.36	TL306V-09P5GS			
Colour	Green or Black	10	96.52	TL306V-10P5GS			
Current	20A (UL) / 12A (VDE)	11	106.68	TL306V-11P5GS			
Voltage	300V (UL) / 250V (VDE)	12	116.84	TL306V-12P5GS			
Approval Bodies							

*xx = number of poles

PCB TERMINAL BLOCKS RISING CLAMP - SINGLE ROW

TL308V-xxP5GS

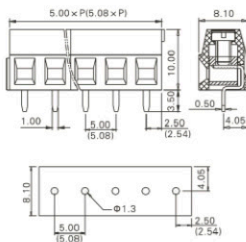

2-12 Pole Screw Rising Clamp Wave -
through hole Vertical 10.16mm pitch

		N° of Poles	Pole Length (mm)	Product Code	N° of Poles	Pole Length (mm)	Product Code
Pitch (mm)	10.16	2	15.24	TL308V-02P5GS			
Wire Size AWG	Min: 26 / Max: 16	3	25.4	TL308V-03P5GS			
Wire Size (mm ²)	Min: 0.2 / Max: 1.5	4	35.56	TL308V-04P5GS			
PCB Hole Ø	1.3	5	45.72	TL308V-05P5GS			
Orientation	Vertical	6	55.88	TL308V-06P5GS			
Mount Type	Wave - Through Hole	7	66.04	TL308V-07P5GS			
Screw	Slot Screw	8	76.2	TL308V-08P5GS			
Join	Interlocking	9	86.36	TL308V-09P5GS			
Colour	Green or Black	10	96.52	TL308V-10P5GS			
Current	10A (UL)	11	106.68	TL308V-11P5GS			
Voltage	150V (UL)	12	116.84	TL308V-12P5GS			
Approval Bodies							

TL312V-xxP5GS

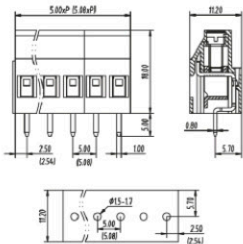

2-12 Pole Screw Rising Clamp Wave -
through hole Vertical 10.16mm pitch

		N° of Poles	Pole Length (mm)	Product Code	N° of Poles	Pole Length (mm)	Product Code
Pitch (mm)	10.16	2	15.24	TL312V-02P5GS			
Wire Size AWG	Min: 24 / Max: 12	3	25.4	TL312V-03P5GS			
Wire Size (mm ²)	Min: 0.34 / Max: 4	4	35.56	TL312V-04P5GS			
PCB Hole Ø	1.5-1.7	5	45.72	TL312V-05P5GS			
Orientation	Vertical	6	55.88	TL312V-06P5GS			
Mount Type	Wave - Through Hole	7	66.04	TL312V-07P5GS			
Screw	Slot Screw	8	76.2	TL312V-08P5GS			
Join	Interlocking	9	86.36	TL312V-09P5GS			
Colour	Green or Black	10	96.52	TL312V-10P5GS			
Current	20A (UL) / 20A (VDE)	11	106.68	TL312V-11P5GS			
Voltage	300V (UL) / 300V (VDE)	12	116.84	TL312V-12P5GS			
Approval Bodies							

TL800V-xxPGS

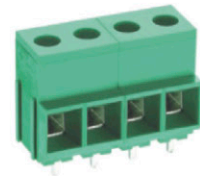
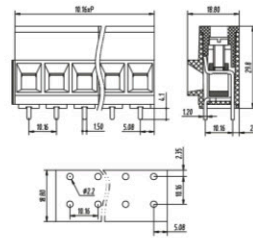

2-24 Pole Screw Rising Clamp Wave -
through hole Vertical 10.16mm pitch

		N° of Poles	Pole Length (mm)	Product Code	N° of Poles	Pole Length (mm)	Product Code
Pitch (mm)	10.16	2	20.32	TL800V-02PGS	14	142.24	TL800V-14PGS
Wire Size AWG	Min: 22 / Max: 6	3	30.48	TL800V-03PGS	15	152.4	TL800V-15PGS
Wire Size (mm ²)	Min: 0.34 / Max: 16	4	40.64	TL800V-04PGS	16	162.56	TL800V-16PGS
PCB Hole Ø	2.2	5	50.8	TL800V-05PGS	17	172.72	TL800V-17PGS
Orientation	Vertical	6	60.96	TL800V-06PGS	18	182.88	TL800V-18PGS
Mount Type	Wave - Through Hole	7	71.12	TL800V-07PGS	19	193.04	TL800V-19PGS
Screw	Slot Screw	8	81.28	TL800V-08PGS	20	203.2	TL800V-20PGS
Join	Interlocking	9	91.44	TL800V-09PGS	21	213.36	TL800V-21PGS
Colour	Green or Black	10	101.6	TL800V-10PGS	22	223.52	TL800V-22PGS
Current	50A (UL)	11	111.76	TL800V-11PGS	23	233.68	TL800V-23PGS
Voltage	600V (UL)	12	121.92	TL800V-12PGS	24	243.84	TL800V-24PGS
Approval Bodies		13	132.08	TL800V-13PGS			

PCB TERMINAL BLOCKS RISING CLAMP - DOUBLE DECKER PCB

TLD001-xxPGS

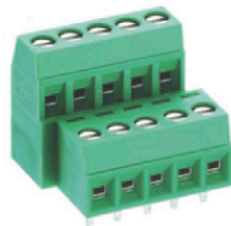
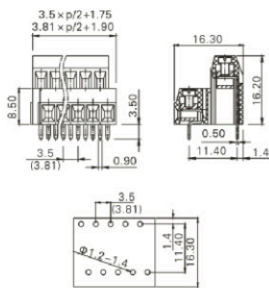

4-48 Pole Screw Rising Clamp Wave - through hole Vertical 3.5mm pitch

		N° of Poles	Pole Length (mm)	Product Code	N° of Poles	Pole Length (mm)	Product Code
Pitch (mm)	3.5	4	8.75	TLD001-04PGS	28	50.75	TLD001-28PGS
Wire Size AWG	Min: 22 / Max: 14	6	12.25	TLD001-06PGS	30	54.25	TLD001-30PGS
Wire Size (mm²)	Min: 0.34 / Max: 2.5	8	15.75	TLD001-08PGS	32	57.75	TLD001-32PGS
PCB Hole Ø	1.2-1.4	10	19.25	TLD001-10PGS	34	61.25	TLD001-34PGS
Orientation	Vertical	12	22.75	TLD001-12PGS	36	64.75	TLD001-36PGS
Mount Type	Wave - Through Hole	14	26.25	TLD001-14PGS	38	68.25	TLD001-38PGS
Screw	Slot Screw	16	29.75	TLD001-16PGS	40	71.75	TLD001-40PGS
Join	Solid body non stackable	18	33.25	TLD001-18PGS	42	75.25	TLD001-42PGS
Colour	Green or Black	20	36.75	TLD001-20PGS	44	78.75	TLD001-44PGS
Current	16A	22	40.25	TLD001-22PGS	46	82.25	TLD001-46PGS
Voltage	300V	24	43.75	TLD001-24PGS	48	85.75	TLD001-48PGS
Approval Bodies	UL	26	47.25	TLD001-26PGS			

TLD100-xxPGS

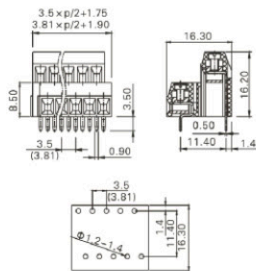

4-48 Pole Screw Rising Clamp Wave - through hole Vertical 3.81mm pitch

		N° of Poles	Pole Length (mm)	Product Code	N° of Poles	Pole Length (mm)	Product Code
Pitch (mm)	3.81	4	9.52	TLD100-04PGS	28	55.24	TLD100-28PGS
Wire Size AWG	Min: 22 / Max: 14	6	13.33	TLD100-06PGS	30	59.05	TLD100-30PGS
Wire Size (mm²)	Min: 0.34 / Max: 2.5	8	17.14	TLD100-08PGS	32	62.86	TLD100-32PGS
PCB Hole Ø	1.2-1.4	10	20.95	TLD100-10PGS	34	66.67	TLD100-34PGS
Orientation	Vertical	12	24.76	TLD100-12PGS	36	70.48	TLD100-36PGS
Mount Type	Wave - Through Hole	14	28.57	TLD100-14PGS	38	74.29	TLD100-38PGS
Screw	Slot Screw	16	32.38	TLD100-16PGS	40	78.1	TLD100-40PGS
Join	Solid body non stackable	18	36.19	TLD100-18PGS	42	81.91	TLD100-42PGS
Colour	Green or Black	20	40	TLD100-20PGS	44	85.72	TLD100-44PGS
Current	16A	22	43.81	TLD100-22PGS	46	89.53	TLD100-46PGS
Voltage	300V	24	47.62	TLD100-24PGS	48	93.34	TLD100-48PGS
Approval Bodies	UL	26	51.43	TLD100-26PGS			

TLD200-xxPGS

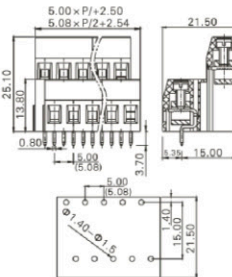

4-48 Pole Screw Rising Clamp Wave - through hole Vertical 5mm pitch

		N° of Poles	Pole Length (mm)	Product Code	N° of Poles	Pole Length (mm)	Product Code
Pitch (mm)	5	4	12.5	TLD200-04PGS	28	72.5	TLD200-28PGS
Wire Size AWG	Min: 30 / Max: 14	6	17.5	TLD200-06PGS	30	77.5	TLD200-30PGS
Wire Size (mm²)	Max: 2.5	8	22.5	TLD200-08PGS	32	82.5	TLD200-32PGS
PCB Hole Ø	1.4-1.5	10	27.5	TLD200-10PGS	34	87.5	TLD200-34PGS
Orientation	Vertical	12	32.5	TLD200-12PGS	36	92.5	TLD200-36PGS
Mount Type	Wave - Through Hole	14	37.5	TLD200-14PGS	38	97.5	TLD200-38PGS
Screw	Slot Screw	16	42.5	TLD200-16PGS	40	102.5	TLD200-40PGS
Join	Interlocking	18	47.5	TLD200-18PGS	42	107.5	TLD200-42PGS
Colour	Green or Black	20	52.5	TLD200-20PGS	44	112.5	TLD200-44PGS
Current	10A	22	57.5	TLD200-22PGS	46	117.5	TLD200-46PGS
Voltage	300V	24	62.5	TLD200-24PGS	48	122.5	TLD200-48PGS
Approval Bodies	UL, CE, RoHS	26	67.5	TLD200-26PGS			

*xx = number of poles

PCB TERMINAL BLOCKS RISING CLAMP - DOUBLE DECKER PCB

TLD201-xxPGS

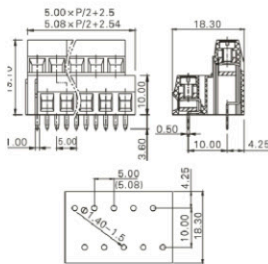

4-48 Pole Screw Rising Clamp Wave - through hole Vertical 5mm pitch

		N° of Poles	Pole Length (mm)	Product Code	N° of Poles	Pole Length (mm)	Product Code
Pitch (mm)	5	4	12.5	TLD201-04PGS	28	72.5	TLD201-28PGS
Wire Size AWG	Min: 30 / Max: 14	6	17.5	TLD201-06PGS	30	77.5	TLD201-30PGS
Wire Size (mm ²)	Max: 2.5	8	22.5	TLD201-08PGS	32	82.5	TLD201-32PGS
PCB Hole Ø	1.4-1.5	10	27.5	TLD201-10PGS	34	87.5	TLD201-34PGS
Orientation	Vertical	12	32.5	TLD201-12PGS	36	92.5	TLD201-36PGS
Mount Type	Wave - Through Hole	14	37.5	TLD201-14PGS	38	97.5	TLD201-38PGS
Screw	Slot Screw	16	42.5	TLD201-16PGS	40	102.5	TLD201-40PGS
Join	Interlocking	18	47.5	TLD201-18PGS	42	107.5	TLD201-42PGS
Colour	Green or Black	20	52.5	TLD201-20PGS	44	112.5	TLD201-44PGS
Current	10A	22	57.5	TLD201-22PGS	46	117.5	TLD201-46PGS
Voltage	300V	24	62.5	TLD201-24PGS	48	122.5	TLD201-48PGS
Approval Bodies		26	67.5	TLD201-26PGS			

TL324VH2-xxPKS

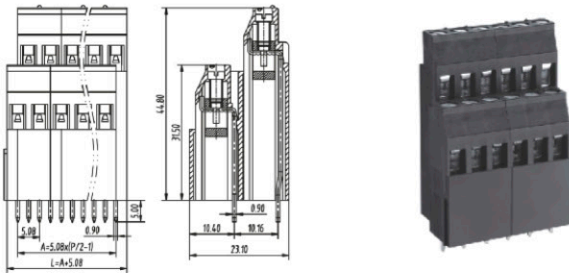

4-48 Pole Screw Rising Clamp
Vertical 5.08mm pitch

		N° of Poles	Pole Length (mm)	Product Code	N° of Poles	Pole Length (mm)	Product Code
Pitch (mm)	5.08	4	10.16	TL324VH2-04PKS	28	71.12	TL324VH2-28PKS
Wire Size AWG	Min: 28 / Max: 10	6	15.24	TL324VH2-06PKS	30	76.2	TL324VH2-30PKS
Wire Size (mm ²)	Max: 6	8	20.32	TL324VH2-08PKS	32	81.28	TL324VH2-32PKS
PCB Hole Ø	1.4-1.5	10	25.4	TL324VH2-10PKS	34	86.36	TL324VH2-34PKS
Orientation	Vertical	12	30.48	TL324VH2-12PKS	36	91.44	TL324VH2-36PKS
Mount Type	Vertical	14	35.56	TL324VH2-14PKS	38	96.52	TL324VH2-38PKS
Screw	Slot Screw	16	40.64	TL324VH2-16PKS	40	101.6	TL324VH2-40PKS
Join	Interlocking	18	45.72	TL324VH2-18PKS	42	106.68	TL324VH2-42PKS
Colour	Green or Black	20	50.8	TL324VH2-20PKS	44	111.76	TL324VH2-44PKS
Current	25A	22	55.88	TL324VH2-22PKS	46	116.84	TL324VH2-46PKS
Voltage	300V	24	60.96	TL324VH2-24PKS	48	121.92	TL324VH2-48PKS
Approval Bodies		26	66.04	TL324VH2-26PKS			

TL324VM2-xxPKS

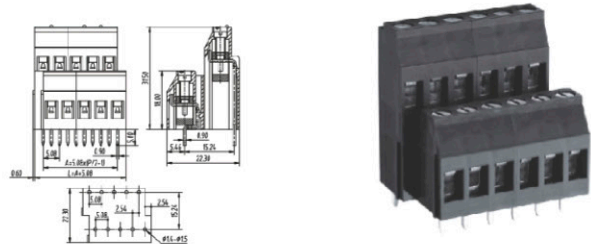

4-48 Pole Screw Rising Clamp
Vertical 5.08mm pitch

		N° of Poles	Pole Length (mm)	Product Code	N° of Poles	Pole Length (mm)	Product Code
Pitch (mm)	5.08	4	10.16	TL324VM2-04PKS	28	71.12	TL324VM2-28PKS
Wire Size AWG	Min: 28 / Max: 10	6	15.24	TL324VM2-06PKS	30	76.2	TL324VM2-30PKS
Wire Size (mm ²)	Max: 6	8	20.32	TL324VM2-08PKS	32	81.28	TL324VM2-32PKS
PCB Hole Ø	1.4-1.5	10	25.4	TL324VM2-10PKS	34	86.36	TL324VM2-34PKS
Orientation	Vertical	12	30.48	TL324VM2-12PKS	36	91.44	TL324VM2-36PKS
Mount Type	Vertical	14	35.56	TL324VM2-14PKS	38	96.52	TL324VM2-38PKS
Screw	Slot Screw	16	40.64	TL324VM2-16PKS	40	101.6	TL324VM2-40PKS
Join	Interlocking	18	45.72	TL324VM2-18PKS	42	106.68	TL324VM2-42PKS
Colour	Green or Black	20	50.8	TL324VM2-20PKS	44	111.76	TL324VM2-44PKS
Current	25A	22	55.88	TL324VM2-22PKS	46	116.84	TL324VM2-46PKS
Voltage	300V	24	60.96	TL324VM2-24PKS	48	121.92	TL324VM2-48PKS
Approval Bodies		26	66.04	TL324VM2-26PKS			

TLD300-xxPGS

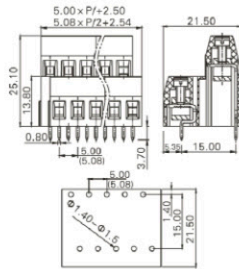

4-48 Pole Screw Rising Clamp Wave - through hole Vertical 5.08mm pitch

	N° of Poles	Pole Length (mm)	Product Code	N° of Poles	Pole Length (mm)	Product Code	
Pitch (mm)	5.08	4	12.7	TLD300-04PGS	28	73.66	TLD300-28PGS
Wire Size AWG	Min: 30 / Max: 14	6	17.78	TLD300-06PGS	30	78.74	TLD300-30PGS
Wire Size (mm²)	Max: 2.5	8	22.86	TLD300-08PGS	32	83.82	TLD300-32PGS
PCB Hole Ø	1.4-1.5	10	27.94	TLD300-10PGS	34	88.9	TLD300-34PGS
Orientation	Vertical	12	33.02	TLD300-12PGS	36	93.98	TLD300-36PGS
Mount Type	Wave - Through Hole	14	38.1	TLD300-14PGS	38	99.06	TLD300-38PGS
Screw	Slot Screw	16	43.18	TLD300-16PGS	40	104.14	TLD300-40PGS
Join	Interlocking	18	48.26	TLD300-18PGS	42	109.22	TLD300-42PGS
Colour	Green or Black	20	53.34	TLD300-20PGS	44	114.3	TLD300-44PGS
Current	10A	22	58.42	TLD300-22PGS	46	119.38	TLD300-46PGS
Voltage	300V	24	63.5	TLD300-24PGS	48	124.46	TLD300-48PGS
Approval Bodies		26	68.58	TLD300-26PGS			

TLD301-xxPGS

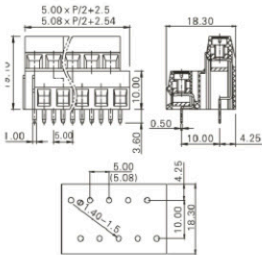

4-48 Pole Screw Rising Clamp Wave - through hole Vertical 5.08mm pitch

	N° of Poles	Pole Length (mm)	Product Code	N° of Poles	Pole Length (mm)	Product Code	
Pitch (mm)	5.08	4	12.7	TLD301-04PGS	28	134.62	TLD301-28PGS
Wire Size AWG	Min: 30 / Max: 14	6	22.86	TLD301-06PGS	30	144.78	TLD301-30PGS
Wire Size (mm²)	Max: 2.5	8	33.02	TLD301-08PGS	32	154.94	TLD301-32PGS
PCB Hole Ø	1.4-1.5	10	43.18	TLD301-10PGS	34	165.1	TLD301-34PGS
Orientation	Vertical	12	53.34	TLD301-12PGS	36	175.26	TLD301-36PGS
Mount Type	Wave - Through Hole	14	63.5	TLD301-14PGS	38	185.42	TLD301-38PGS
Screw	Slot Screw	16	73.66	TLD301-16PGS	40	195.58	TLD301-40PGS
Join	Interlocking	18	83.82	TLD301-18PGS	42	205.74	TLD301-42PGS
Colour	Green or Black	20	93.98	TLD301-20PGS	44	215.9	TLD301-44PGS
Current	10A	22	104.14	TLD301-22PGS	46	226.06	TLD301-46PGS
Voltage	300V	24	114.3	TLD301-24PGS	48	236.22	TLD301-48PGS
Approval Bodies		26	124.46	TLD301-26PGS			

YOUR NOTES

*xx = number of poles

PCB TERMINAL BLOCKS RISING CLAMP - TRIPLE DECKER PCB

TL324VH3-xxPKS

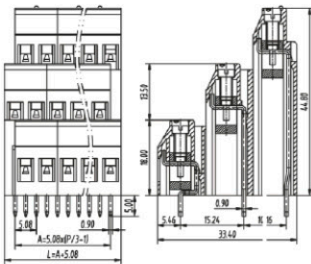

6-72 Pole Screw Rising Clamp
Vertical 5.08mm pitch

		N° of Poles	Pole Length (mm)	Product Code	N° of Poles	Pole Length (mm)	Product Code
Pitch (mm)	5.08	6	10.16	TL324VH3-06PKS	42	71.12	TL324VH3-42PKS
Wire Size AWG	Min: 28 / Max: 10	9	15.24	TL324VH3-09PKS	45	76.2	TL324VH3-45PKS
Wire Size (mm ²)	Max: 6	12	20.32	TL324VH3-12PKS	48	81.28	TL324VH3-48PKS
PCB Hole Ø	1.4-1.5	15	25.4	TL324VH3-15PKS	51	86.36	TL324VH3-51PKS
Orientation	Vertical	18	30.48	TL324VH3-18PKS	54	91.44	TL324VH3-54PKS
Mount Type	Vertical	21	35.56	TL324VH3-21PKS	57	96.52	TL324VH3-57PKS
Screw	Slot Screw	24	40.64	TL324VH3-24PKS	60	101.6	TL324VH3-60PKS
Join	Interlocking	27	45.72	TL324VH3-28PKS	63	106.68	TL324VH3-63PKS
Colour	Green or Black	30	50.8	TL324VH3-30PKS	66	111.76	TL324VH3-66PKS
Current	25A	33	55.88	TL324VH3-33PKS	69	116.84	TL324VH3-69PKS
Voltage	300V	36	60.96	TL324VH3-36PKS	72	121.92	TL324VH3-72PKS
Approval Bodies		39	66.04	TL324VH3-39PKS			

PCB TERMINAL
BLOCKS SCREWLESS
PUSH WIRE: PITCH
2.5, 2.54, 3.5, 5.0, 5.08 /
POLES 2-24



PCB TERMINAL BLOCKS SCREWLESS - PUSH WIRE

TLM250C-xxP

2 Pole Spring - Screwless Pushbutton Wave
- through hole Long pin close to side cover
2.5mm pitch

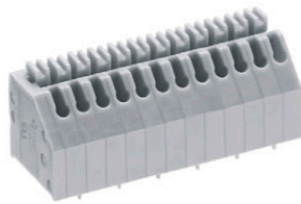
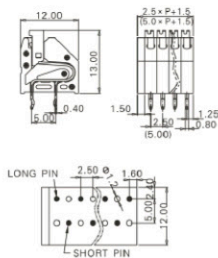

		N° of Poles	Pole Length (mm)	Product Code	N° of Poles	Pole Length (mm)	Product Code
Pitch (mm)	2.5	2	6.5	TLM250C-02P	14	36.5	TLM250C-14P
Wire Size AWG	Min: 20	3	9	TLM250C-03P	15	39	TLM250C-15P
Wire Size (mm²)	Min: 0.2 / Max: 05	4	11.5	TLM250C-04P	16	41.5	TLM250C-16P
PCB Hole Ø	1.2	5	14	TLM250C-05P	17	44	TLM250C-17P
Orientation	Long pin close to side cover	6	16.5	TLM250C-06P	18	46.5	TLM250C-18P
Mount Type	Wave - Through Hole	7	19	TLM250C-07P	19	49	TLM250C-19P
Join	End stackable	8	21.5	TLM250C-08P	20	51.5	TLM250C-20P
Colour	Green or Grey	9	24	TLM250C-09P	21	54	TLM250C-21P
Current	2A	10	26.5	TLM250C-10P	22	56.5	TLM250C-22P
Voltage	250V	11	29	TLM250C-11P	23	59	TLM250C-23P
Approval Bodies		12	31.5	TLM250C-12P	24	61.5	TLM250C-24P
		13	34	TLM250C-13P			



TLM250D-xxP

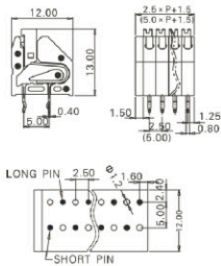

2 Pole Spring - Screwless Pushbutton Wave
- through hole Short pin close to side cover
2.5mm pitch

		N° of Poles	Pole Length (mm)	Product Code	N° of Poles	Pole Length (mm)	Product Code
Pitch (mm)	2.5	2	6.5	TLM250D-02P	14	36.5	TLM250D-14P
Wire Size AWG	Min: 20	3	9	TLM250D-03P	15	39	TLM250D-15P
Wire Size (mm²)	Min: 0.2 / Max: 05	4	11.5	TLM250D-04P	16	41.5	TLM250D-16P
PCB Hole Ø	1.2	5	14	TLM250D-05P	17	44	TLM250D-17P
Orientation	Short pin close to side cover	6	16.5	TLM250D-06P	18	46.5	TLM250D-18P
Mount Type	Wave - Through Hole	7	19	TLM250D-07P	19	49	TLM250D-19P
Join	End stackable	8	21.5	TLM250D-08P	20	51.5	TLM250D-20P
Colour	Green or Grey	9	24	TLM250D-09P	21	54	TLM250D-21P
Current	2A	10	26.5	TLM250D-10P	22	56.5	TLM250D-22P
Voltage	250V	11	29	TLM250D-11P	23	59	TLM250D-23P
Approval Bodies		12	31.5	TLM250D-12P	24	61.5	TLM250D-24P
		13	34	TLM250D-13P			

TLM900R-xxP

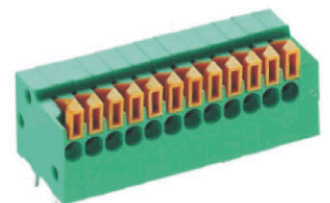
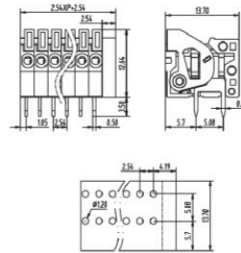

2 Pole Spring - Screwless Pushbutton Wave
- through hole Horizontal 2.54mm pitch

		N° of Poles	Pole Length (mm)	Product Code	N° of Poles	Pole Length (mm)	Product Code
Pitch (mm)	2.54	2	7.62	TLM900R-02P	14	38.1	TLM900R-14P
Wire Size AWG	Min: 26 / Max: 20	3	10.16	TLM900R-03P	15	40.64	TLM900R-15P
Wire Size (mm²)	Min: 0.2 / Max: 0.5	4	12.7	TLM900R-04P	16	43.18	TLM900R-16P
PCB Hole Ø	1.2	5	15.24	TLM900R-05P	17	45.72	TLM900R-17P
Orientation	Horizontal	6	17.78	TLM900R-06P	18	48.26	TLM900R-18P
Mount Type	Wave - Through Hole	7	20.32	TLM900R-07P	19	50.8	TLM900R-19P
Join	End stackable	8	22.86	TLM900R-08P	20	53.34	TLM900R-20P
Colour	Green or Grey	9	25.4	TLM900R-09P	21	55.88	TLM900R-21P
Current	2A	10	27.94	TLM900R-10P	22	58.42	TLM900R-22P
Voltage	150V	11	30.48	TLM900R-11P	23	60.96	TLM900R-23P
Approval Bodies		12	33.02	TLM900R-12P	24	63.5	TLM900R-24P
		13	35.56	TLM900R-13P			

*xx = number of poles

PCB TERMINAL BLOCKS SCREWLESS - PUSH WIRE

TLM900V-xxP

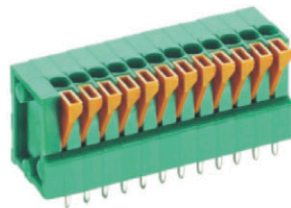
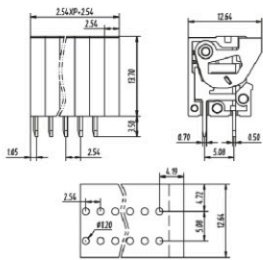

2 Pole Spring - Screwless Pushbutton Wave
- through hole Vertical 2.54mm pitch

		N° of Poles	Pole Length (mm)	Product Code	N° of Poles	Pole Length (mm)	Product Code
Pitch (mm)	2.54	2	7.62	TLM900V-02P	14	38.1	TLM900V-14P
Wire Size AWG	Min: 26 / Max: 20	3	10.16	TLM900V-03P	15	40.64	TLM900V-15P
Wire Size (mm ²)	Min: 0.2 / Max: 0.5	4	12.7	TLM900V-04P	16	43.18	TLM900V-16P
PCB Hole Ø	1.2	5	15.24	TLM900V-05P	17	45.72	TLM900V-17P
Orientation	Vertical	6	17.78	TLM900V-06P	18	48.26	TLM900V-18P
Mount Type	Wave - Through Hole	7	20.32	TLM900V-07P	19	50.8	TLM900V-19P
Join	End stackable	8	22.86	TLM900V-08P	20	53.34	TLM900V-20P
Colour	Green or Grey	9	25.4	TLM900V-09P	21	55.88	TLM900V-21P
Current	2A	10	27.94	TLM900V-10P	22	58.42	TLM900V-22P
Voltage	150V	11	30.48	TLM900V-11P	23	60.96	TLM900V-23P
Approval Bodies		12	33.02	TLM900V-12P	24	63.5	TLM900V-24P
		13	35.56	TLM900V-13P			

TLM002C-xxP

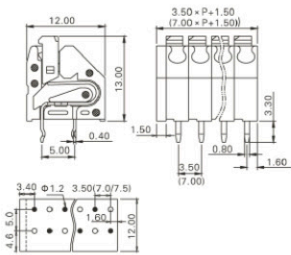

2 Pole Spring - Screwless Pushbutton Wave
- through hole Long pin close to side cover
3.5mm pitch

		N° of Poles	Pole Length (mm)	Product Code	N° of Poles	Pole Length (mm)	Product Code
Pitch (mm)	3.5	2	8.5	TLM002C-02P	14	50.5	TLM002C-14P
Wire Size AWG	Min: 22 / Max: 14	3	12	TLM002C-03P	15	54	TLM002C-15P
Wire Size (mm ²)	Min: 0.5 / Max: 0.75	4	15.5	TLM002C-04P	16	57.5	TLM002C-16P
PCB Hole Ø	1.2	5	19	TLM002C-05P	17	61	TLM002C-17P
Orientation	Long pin close to side cover	6	22.5	TLM002C-06P	18	64.5	TLM002C-18P
Mount Type	Wave - Through Hole	7	26	TLM002C-07P	19	68	TLM002C-19P
Join	End stackable	8	29.5	TLM002C-08P	20	71.5	TLM002C-20P
Colour	Green or Grey	9	33	TLM002C-09P	21	75	TLM002C-21P
Current	2A	10	36.5	TLM002C-10P	22	78.5	TLM002C-22P
Voltage	250V	11	40	TLM002C-11P	23	82	TLM002C-23P
Approval Bodies		12	43.5	TLM002C-12P	24	85.5	TLM002C-24P
		13	47	TLM002C-13P			

TLM002D-xxP

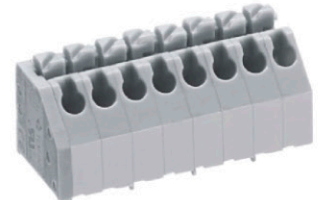
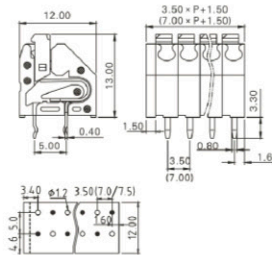

2 Pole Spring - Screwless Pushbutton Wave
- through hole Short pin close to side cover
3.5mm pitch

		N° of Poles	Pole Length (mm)	Product Code	N° of Poles	Pole Length (mm)	Product Code
Pitch (mm)	3.5	2	8.5	TLM002D-02P	14	50.5	TLM002D-14P
Wire Size AWG	Min: 22 / Max: 14	3	12	TLM002D-03P	15	54	TLM002D-15P
Wire Size (mm ²)	Min: 0.5 / Max: 0.75	4	15.5	TLM002D-04P	16	57.5	TLM002D-16P
PCB Hole Ø	1.2	5	19	TLM002D-05P	17	61	TLM002D-17P
Orientation	Short pin close to side cover	6	22.5	TLM002D-06P	18	64.5	TLM002D-18P
Mount Type	Wave - Through Hole	7	26	TLM002D-07P	19	68	TLM002D-19P
Join	End stackable	8	29.5	TLM002D-08P	20	71.5	TLM002D-20P
Colour	Green or Grey	9	33	TLM002D-09P	21	75	TLM002D-21P
Current	2A	10	36.5	TLM002D-10P	22	78.5	TLM002D-22P
Voltage	250V	11	40	TLM002D-11P	23	82	TLM002D-23P
Approval Bodies		12	43.5	TLM002D-12P	24	85.5	TLM002D-24P
		13	47	TLM002D-13P			

Features:

- Standard colour options include Green or Grey

TLM203-xxP

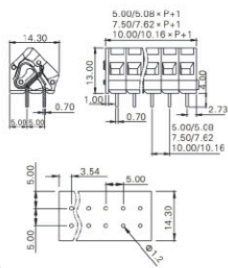

2 Pole Spring - Screwless Tool operated Wave - through hole 45 degree 5mm pitch

	N° of Poles	Pole Length (mm)	Product Code	N° of Poles	Pole Length (mm)	Product Code
Pitch (mm)	5	2 11	TLM203-02P	14	71	TLM203-14P
Wire Size AWG	Min: 28 / Max: 12	3 16	TLM203-03P	15	76	TLM203-15P
Wire Size (mm²)	Max: 4	4 21	TLM203-04P	16	81	TLM203-16P
PCB Hole Ø	1.2	5 26	TLM203-05P	17	86	TLM203-17P
Orientation	45 degree	6 31	TLM203-06P	18	91	TLM203-18P
Mount Type	Wave - Through Hole	7 36	TLM203-07P	19	96	TLM203-19P
Join	End stackable	8 41	TLM203-08P	20	101	TLM203-20P
Colour	Green or Grey	9 46	TLM203-09P	21	106	TLM203-21P
Current	15A	10 51	TLM203-10P	22	111	TLM203-22P
Voltage	300V	11 56	TLM203-11P	23	116	TLM203-23P
Approval Bodies		12 61	TLM203-12P	24	121	TLM203-24P
		13 66	TLM203-13P			

TLM201R-xxP

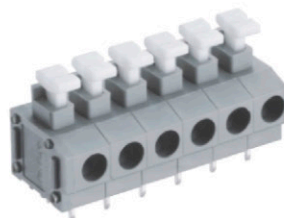
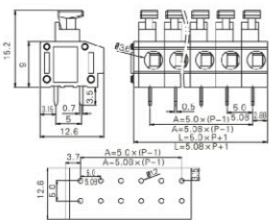

2 Pole Spring - Screwless Pushbutton Wave - through hole Horizontal 5mm pitch

	N° of Poles	Pole Length (mm)	Product Code	N° of Poles	Pole Length (mm)	Product Code
Pitch (mm)	5	2 11	TLM201R-02P	14	71	TLM201R-14P
Wire Size AWG	Min: 20 / Max: 14	3 16	TLM201R-03P	15	76	TLM201R-15P
Wire Size (mm²)	Max: 2.5	4 21	TLM201R-04P	16	81	TLM201R-16P
PCB Hole Ø	1.2	5 26	TLM201R-05P	17	86	TLM201R-17P
Orientation	Horizontal	6 31	TLM201R-06P	18	91	TLM201R-18P
Mount Type	Wave - Through Hole	7 36	TLM201R-07P	19	96	TLM201R-19P
Join	End stackable	8 41	TLM201R-08P	20	101	TLM201R-20P
Colour	Green or Grey	9 46	TLM201R-09P	21	106	TLM201R-21P
Current	10A	10 51	TLM201R-10P	22	111	TLM201R-22P
Voltage	300V	11 56	TLM201R-11P	23	116	TLM201R-23P
Approval Bodies		12 61	TLM201R-12P	24	121	TLM201R-24P
		13 66	TLM201R-13P			

TLM202R-xxP

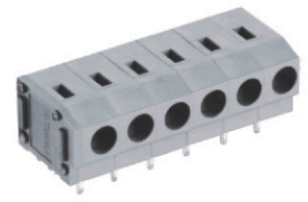
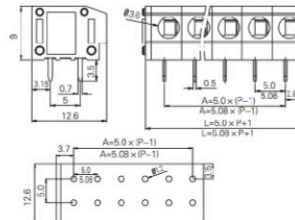

2 Pole Spring - Screwless Tool operated Wave - through hole Horizontal 5mm pitch

	N° of Poles	Pole Length (mm)	Product Code	N° of Poles	Pole Length (mm)	Product Code
Pitch (mm)	5	2 11	TLM202R-02P	14	71	TLM202R-14P
Wire Size AWG	Min: 20 / Max: 14	3 16	TLM202R-03P	15	76	TLM202R-15P
Wire Size (mm²)	Max: 2.5	4 21	TLM202R-04P	16	81	TLM202R-16P
PCB Hole Ø	1.2	5 26	TLM202R-05P	17	86	TLM202R-17P
Orientation	Horizontal	6 31	TLM202R-06P	18	91	TLM202R-18P
Mount Type	Wave - Through Hole	7 36	TLM202R-07P	19	96	TLM202R-19P
Join	End stackable	8 41	TLM202R-08P	20	101	TLM202R-20P
Colour	Green or Grey	9 46	TLM202R-09P	21	106	TLM202R-21P
Current	10A	10 51	TLM202R-10P	22	111	TLM202R-22P
Voltage	300V	11 56	TLM202R-11P	23	116	TLM202R-23P
Approval Bodies		12 61	TLM202R-12P	24	121	TLM202R-24P
		13 66	TLM202R-13P			

*xx = number of poles

PCB TERMINAL BLOCKS SCREWLESS - PUSH WIRE

TLM204-xxP

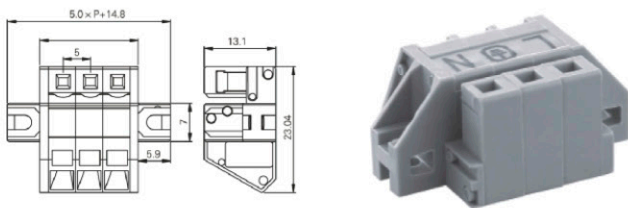

2 Pole Spring - Screwless Tool operated
5mm pitch

		N° of Poles	Pole Length (mm)	Product Code	N° of Poles	Pole Length (mm)	Product Code
Pitch (mm)	5	2	24.8	TLM204-02P	14	84.8	TLM204-14P
Wire Size AWG	Min: 22 / Max: 12	3	29.8	TLM204-03P	15	89.8	TLM204-15P
Wire Size (mm ²)	Min: 0.34 / Max: 4	4	34.8	TLM204-04P	16	94.8	TLM204-16P
PCB Hole Ø		5	39.8	TLM204-05P	17	99.8	TLM204-17P
Orientation		6	44.8	TLM204-06P	18	104.8	TLM204-18P
Mount Type		7	49.8	TLM204-07P	19	109.8	TLM204-19P
Join	Solid body non stackable	8	54.8	TLM204-08P	20	114.8	TLM204-20P
Colour	Green or Grey	9	59.8	TLM204-09P	21	119.8	TLM204-21P
Current	15A	10	64.8	TLM204-10P	22	124.8	TLM204-22P
Voltage	300V	11	69.8	TLM204-11P	23	129.8	TLM204-23P
Approval Bodies		12	74.8	TLM204-12P	24	134.8	TLM204-24P
		13	79.8	TLM204-13P			

TLM303-xxP

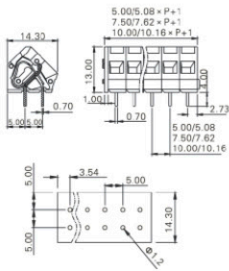

2 Pole Spring - Screwless Tool operated
Wave - through hole 45 degree 5.08mm
pitch

		N° of Poles	Pole Length (mm)	Product Code	N° of Poles	Pole Length (mm)	Product Code
Pitch (mm)	5.08	2	11.16	TLM303-02P	14	72.12	TLM303-14P
Wire Size AWG	Min: 28 / Max: 12	3	16.24	TLM303-03P	15	77.2	TLM303-15P
Wire Size (mm ²)	Max: 4	4	21.32	TLM303-04P	16	82.28	TLM303-16P
PCB Hole Ø	1.2	5	26.4	TLM303-05P	17	87.36	TLM303-17P
Orientation	45 degree	6	31.48	TLM303-06P	18	92.44	TLM303-18P
Mount Type	Wave - Through Hole	7	36.56	TLM303-07P	19	97.52	TLM303-19P
Join	End Stackable	8	41.64	TLM303-08P	20	102.6	TLM303-20P
Colour	Green or Grey	9	46.72	TLM303-09P	21	107.68	TLM303-21P
Current	15A	10	51.8	TLM303-10P	22	112.76	TLM303-22P
Voltage	300V	11	56.88	TLM303-11P	23	117.84	TLM303-23P
Approval Bodies		12	61.96	TLM303-12P	24	122.92	TLM303-24P
		13	67.04	TLM303-13P			

TLM300R-xxP

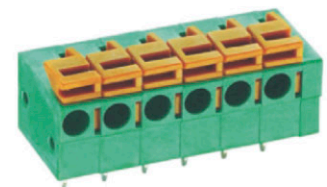
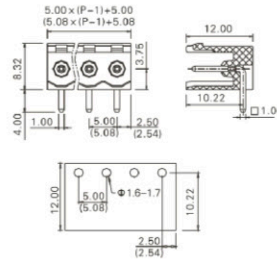

2 Pole Spring - Screwless Pushbutton Wave
- through hole Horizontal 5.08mm pitch

		N° of Poles	Pole Length (mm)	Product Code	N° of Poles	Pole Length (mm)	Product Code
Pitch (mm)	5.08	2	12.7	TLM300R-02P	14	73.66	TLM300R-14P
Wire Size AWG	Min: 22 / Max: 14	3	17.78	TLM300R-03P	15	78.74	TLM300R-15P
Wire Size (mm ²)	Min: 0.34 / Max: 2.5	4	22.86	TLM300R-04P	16	83.82	TLM300R-16P
PCB Hole Ø	1.2	5	27.94	TLM300R-05P	17	88.9	TLM300R-17P
Orientation	Horizontal	6	33.02	TLM300R-06P	18	93.98	TLM300R-18P
Mount Type	Wave - Through Hole	7	38.1	TLM300R-07P	19	99.06	TLM300R-19P
Join	End stackable	8	43.18	TLM300R-08P	20	104.14	TLM300R-20P
Colour	Green or Grey	9	48.26	TLM300R-09P	21	109.22	TLM300R-21P
Current	10A	10	53.34	TLM300R-10P	22	114.3	TLM300R-22P
Voltage	300V	11	58.42	TLM300R-11P	23	119.38	TLM300R-23P
Approval Bodies		12	63.5	TLM300R-12P	24	124.46	TLM300R-24P
		13	68.58	TLM300R-13P			

Features:

- Standard colour options include Green or Grey

TLM301R-xxP

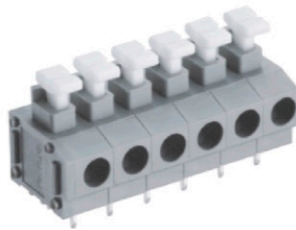
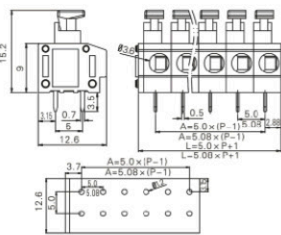

2 Pole Spring - Screwless Pushbutton Wave - through hole Horizontal 5.08mm pitch

		N° of Poles	Pole Length (mm)	Product Code	N° of Poles	Pole Length (mm)	Product Code
Pitch (mm)	5.08	2	11.16	TLM301R-02P	14	72.12	TLM301R-14P
Wire Size AWG	Min: 20 / Max: 14	3	16.24	TLM301R-03P	15	77.2	TLM301R-15P
Wire Size (mm ²)	Min: 0.5 / Max: 2.5	4	21.32	TLM301R-04P	16	82.28	TLM301R-16P
PCB Hole Ø	1.2	5	26.4	TLM301R-05P	17	87.36	TLM301R-17P
Orientation	Horizontal	6	31.48	TLM301R-06P	18	92.44	TLM301R-18P
Mount Type	Wave - Through Hole	7	36.56	TLM301R-07P	19	97.52	TLM301R-19P
Join	End Stackable	8	41.64	TLM301R-08P	20	102.6	TLM301R-20P
Colour	Green or Grey	9	46.72	TLM301R-09P	21	107.68	TLM301R-21P
Current	10A	10	51.8	TLM301R-10P	22	112.76	TLM301R-22P
Voltage	300V	11	56.88	TLM301R-11P	23	117.84	TLM301R-23P
Approval Bodies		12	61.96	TLM301R-12P	24	122.92	TLM301R-24P
		13	67.04	TLM301R-13P			

TLM302R-xxP

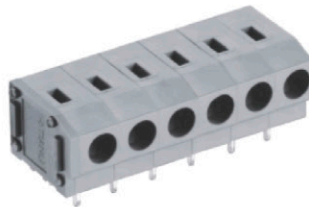
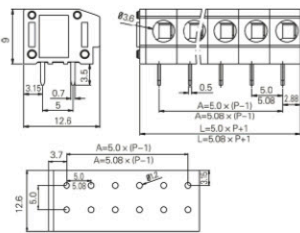

2 Pole Spring - Screwless Tool operated Wave - through hole Horizontal 5.08mm pitch

		N° of Poles	Pole Length (mm)	Product Code	N° of Poles	Pole Length (mm)	Product Code
Pitch (mm)	5.08	2	11.16	TLM302R-02P	14	72.12	TLM302R-14P
Wire Size AWG	Min: 20 / Max: 14	3	16.24	TLM302R-03P	15	82.28	TLM302R-15P
Wire Size (mm ²)	Min: 0.5 / Max: 2.5	4	21.32	TLM302R-04P	16	87.36	TLM302R-16P
PCB Hole Ø	1.2	5	26.4	TLM302R-05P	17	92.44	TLM302R-17P
Orientation	Horizontal	6	31.48	TLM302R-06P	18	97.52	TLM302R-18P
Mount Type	Wave - Through Hole	7	36.56	TLM302R-07P	19	102.6	TLM302R-19P
Join	End Stackable	8	41.64	TLM302R-08P	20	107.68	TLM302R-20P
Colour	Green or Grey	9	46.72	TLM302R-09P	21	112.76	TLM302R-21P
Current	10A	10	51.8	TLM302R-10P	22	117.84	TLM302R-22P
Voltage	300V	11	56.88	TLM302R-11P	23	122.92	TLM302R-23P
Approval Bodies		12	61.96	TLM302R-12P	24	122.87	TLM302R-24P
		13	67.04	TLM302R-13P			

TLM300V-xxP

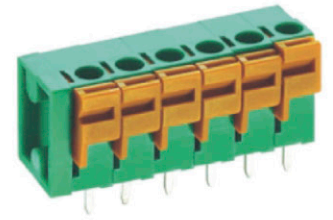
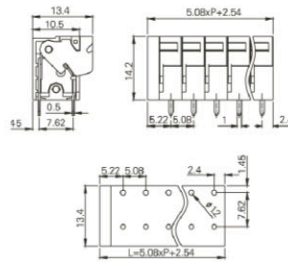

2 Pole Spring - Screwless Pushbutton Wave - through hole Vertical 5.08mm pitch

		N° of Poles	Pole Length (mm)	Product Code	N° of Poles	Pole Length (mm)	Product Code
Pitch (mm)	5.08	2	12.7	TLM300V-02P	14	73.66	TLM300V-14P
Wire Size AWG	Min: 22 / Max: 14	3	17.78	TLM300V-03P	15	78.74	TLM300V-15P
Wire Size (mm ²)	Min: 0.34 / Max: 2.5	4	22.86	TLM300V-04P	16	83.82	TLM300V-16P
PCB Hole Ø	1.2	5	27.94	TLM300V-05P	17	88.9	TLM300V-17P
Orientation	Vertical	6	33.02	TLM300V-06P	18	93.98	TLM300V-18P
Mount Type	Wave - Through Hole	7	38.1	TLM300V-07P	19	99.06	TLM300V-19P
Join	End stackable	8	43.18	TLM300V-08P	20	104.14	TLM300V-20P
Colour	Green or Grey	9	48.26	TLM300V-09P	21	109.22	TLM300V-21P
Current	10A	10	53.34	TLM300V-10P	22	114.3	TLM300V-22P
Voltage	300V	11	58.42	TLM300V-11P	23	119.38	TLM300V-23P
Approval Bodies		12	63.5	TLM300V-12P	24	124.46	TLM300V-24P
		13	68.58	TLM300V-13P			

*xx = number of poles

PCB TERMINAL BLOCKS SCREWLESS - PUSH WIRE

TLM304-xxP

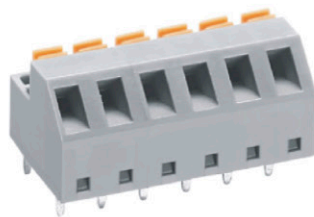
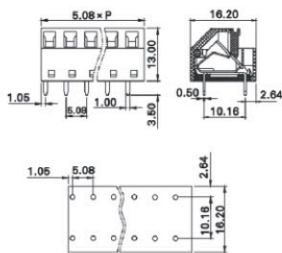

2 Pole Spring - Screwless Pushbutton Wave
- through hole 45 degree 5.08mm pitch

		N° of Poles	Pole Length (mm)	Product Code	N° of Poles	Pole Length (mm)	Product Code
Pitch (mm)	5.08	2	10.16	TLM304-02P	14	71.12	TLM304-14P
Wire Size AWG	Min: 22 / Max: 14	3	15.24	TLM304-03P	15	76.2	TLM304-15P
Wire Size (mm ²)	Min: 0.34 / Max: 2.5	4	20.32	TLM304-04P	16	81.28	TLM304-16P
PCB Hole Ø	1.2	5	25.4	TLM304-05P	17	86.36	TLM304-17P
Orientation	45 degree	6	30.48	TLM304-06P	18	91.44	TLM304-18P
Mount Type	Wave - Through Hole	7	35.56	TLM304-07P	19	96.52	TLM304-19P
Join	Solid body non stackable	8	40.64	TLM304-08P	20	101.6	TLM304-20P
Colour	Green or Grey	9	45.72	TLM304-09P	21	106.68	TLM304-21P
Current	12A	10	50.8	TLM304-10P	22	111.76	TLM304-22P
Voltage	300V	11	55.88	TLM304-11P	23	116.84	TLM304-23P
Approval Bodies		12	60.96	TLM304-12P	24	121.92	TLM304-24P
		13	66.04	TLM304-13P			

TLM403-xxP

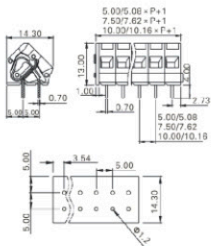

2 Pole Spring - Screwless Tool operated
Wave - through hole 45 degree 7.5mm
pitch

		N° of Poles	Pole Length (mm)	Product Code	N° of Poles	Pole Length (mm)	Product Code
Pitch (mm)	7.5	2	16	TLM403-02P	14	106	TLM403-14P
Wire Size AWG	Min: 28 / Max: 12	3	23.5	TLM403-03P	15	113.5	TLM403-15P
Wire Size (mm ²)	Max: 4	4	31	TLM403-04P	16	121	TLM403-16P
PCB Hole Ø	1.2	5	38.5	TLM403-05P	17	128.5	TLM403-17P
Orientation	45 degree	6	46	TLM403-06P	18	136	TLM403-18P
Mount Type	Wave - Through Hole	7	53.5	TLM403-07P	19	143.5	TLM403-19P
Join	End stackable	8	61	TLM403-08P	20	151	TLM403-20P
Colour	Green or Grey	9	68.5	TLM403-09P	21	158.5	TLM403-21P
Current	15A	10	76	TLM403-10P	22	166	TLM403-22P
Voltage	300V	11	83.5	TLM403-11P	23	173.5	TLM403-23P
Approval Bodies		12	91	TLM403-12P	24	181	TLM403-24P
		13	98.5	TLM403-13P			

TLM503-xxP

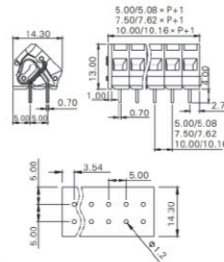

2 Pole Spring - Screwless Tool operated
Wave - through hole 45 degree 7.62mm
pitch

		N° of Poles	Pole Length (mm)	Product Code	N° of Poles	Pole Length (mm)	Product Code
Pitch (mm)	7.62	2	16.24	TLM503-02P	14	107.68	TLM503-14P
Wire Size AWG	Min: 28 / Max: 12	3	23.86	TLM503-03P	15	115.3	TLM503-15P
Wire Size (mm ²)	Max: 4	4	31.48	TLM503-04P	16	122.92	TLM503-16P
PCB Hole Ø	1.2	5	39.1	TLM503-05P	17	130.54	TLM503-17P
Orientation	45 degree	6	46.72	TLM503-06P	18	138.16	TLM503-18P
Mount Type	Wave - Through Hole	7	54.34	TLM503-07P	19	145.78	TLM503-19P
Join	End stackable	8	61.96	TLM503-08P	20	153.4	TLM503-20P
Colour	Green or Grey	9	69.58	TLM503-09P	21	161.02	TLM503-21P
Current	15A	10	77.2	TLM503-10P	22	168.64	TLM503-22P
Voltage	300V	11	84.82	TLM503-11P	23	176.26	TLM503-23P
Approval Bodies		12	92.44	TLM503-12P	24	183.88	TLM503-24P
		13	100.06	TLM503-13P			

PCB TERMINAL BLOCKS - PLUGGABLE PIN HEADER (MALE) - SINGLE ROW PCB HEADER

TLPHC-003V-xxP

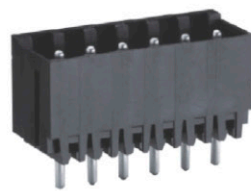
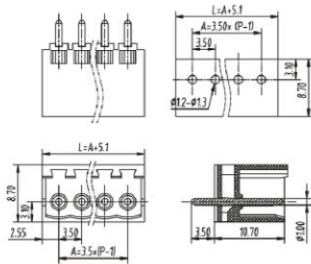

2-24 Pole Pluggable type Vertical
3.5mm pitch

		N° of Poles	Pole Length (mm)	Product Code	N° of Poles	Pole Length (mm)	Product Code
Pitch (mm)	3.5	2	8.6	TLPHC-003V-02P	14	50.6	TLPHC-003V-14P
PCB Hole Ø	1.2-1.3	3	12.1	TLPHC-003V-03P	15	54.1	TLPHC-003V-15P
Orientation	Vertical	4	15.6	TLPHC-003V-04P	16	57.6	TLPHC-003V-16P
Mount Type	Vertical	5	19.1	TLPHC-003V-05P	17	61.1	TLPHC-003V-17P
Screw	Slot Screw	6	22.6	TLPHC-003V-06P	18	64.6	TLPHC-003V-18P
Flange		7	26.1	TLPHC-003V-07P	19	68.1	TLPHC-003V-19P
Join	Solid body non stackable	8	29.6	TLPHC-003V-08P	20	71.6	TLPHC-003V-20P
Colour	Green or Black	9	33.1	TLPHC-003V-09P	21	75.1	TLPHC-003V-21P
Current	10A (UL)	10	36.6	TLPHC-003V-10P	22	78.6	TLPHC-003V-22P
Voltage	300V (UL)	11	40.1	TLPHC-003V-11P	23	82.1	TLPHC-003V-23P
Approval Bodies		12	43.6	TLPHC-003V-12P	24	85.6	TLPHC-003V-24P
		13	47.1	TLPHC-003V-13P			

TL006P-xxPK

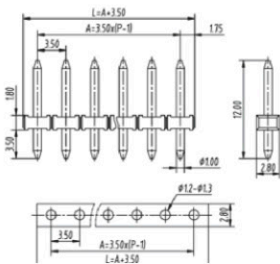

2-24 Pole PCB mount - Male header Wave -
through hole Vertical 3.5mm pitch

		N° of Poles	Pole Length (mm)	Product Code	N° of Poles	Pole Length (mm)	Product Code
Pitch (mm)	3.5	2	7	TL006P-02PK	14	49	TL006P-14PK
PCB Hole Ø	1.2-1.3	3	10.5	TL006P-03PK	15	52.5	TL006P-15PK
Orientation	Vertical	4	14	TL006P-04PK	16	56	TL006P-16PK
Mount Type	Wave - Through Hole	5	17.5	TL006P-05PK	17	59.5	TL006P-17PK
Screw	Slot Screw	6	21	TL006P-06PK	18	63	TL006P-18PK
Flange		7	24.5	TL006P-07PK	19	66.5	TL006P-19PK
Join	Solid body non stackable	8	28	TL006P-08PK	20	70	TL006P-20PK
Colour	Green or Black	9	31.5	TL006P-09PK	21	73.5	TL006P-21PK
Current	10A	10	35	TL006P-10PK	22	77	TL006P-22PK
Voltage	300V	11	38.5	TL006P-11PK	23	80.5	TL006P-23PK
Approval Bodies		12	42	TL006P-12PK	24	84	TL006P-24PK
		13	45.5	TL006P-13PK			

TL007P-xxPK

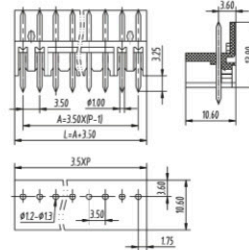

2-24 Pole PCB mount - Male header Wave -
through hole Vertical 3.5mm pitch

		N° of Poles	Pole Length (mm)	Product Code	N° of Poles	Pole Length (mm)	Product Code
Pitch (mm)	3.5	2	7	TL007P-02PK	14	49	TL007P-14PK
PCB Hole Ø	1.4	3	10.5	TL007P-03PK	15	52.5	TL007P-15PK
Orientation	Vertical	4	14	TL007P-04PK	16	56	TL007P-16PK
Mount Type	Wave - Through Hole	5	17.5	TL007P-05PK	17	59.5	TL007P-17PK
Screw	Slot Screw	6	21	TL007P-06PK	18	63	TL007P-18PK
Flange		7	24.5	TL007P-07PK	19	66.5	TL007P-19PK
Join	Solid body non stackable	8	28	TL007P-08PK	20	70	TL007P-20PK
Colour	Green or Black	9	31.5	TL007P-09PK	21	73.5	TL007P-21PK
Current	10A	10	35	TL007P-10PK	22	77	TL007P-22PK
Voltage	300V	11	38.5	TL007P-11PK	23	80.5	TL007P-23PK
Approval Bodies		12	42	TL007P-12PK	24	84	TL007P-24PK
		13	45.5	TL007P-13PK			

*xx = number of poles

PCB TERMINAL BLOCKS - PLUGGABLE PIN HEADER (MALE) - SINGLE ROW PCB HEADER

TLPHC-001V-xxP

2-24 Pole PCB mount - Male header Wave - through hole Vertical 3.5mm pitch

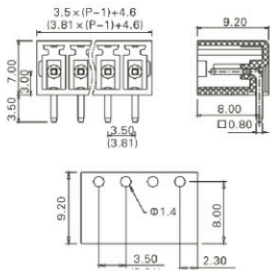

		N° of Poles	Pole Length (mm)	Product Code	N° of Poles	Pole Length (mm)	Product Code
Pitch (mm)	3.5	2	8.1	TLPHC-001V-02P	14	50.1	TLPHC-001V-14P
PCB Hole Ø	1.4	3	11.6	TLPHC-001V-03P	15	53.6	TLPHC-001V-15P
Orientation	Vertical	4	15.1	TLPHC-001V-04P	16	57.1	TLPHC-001V-16P
Mount Type	Wave - Through Hole	5	18.6	TLPHC-001V-05P	17	60.6	TLPHC-001V-17P
Screw	Slot Screw	6	22.1	TLPHC-001V-06P	18	64.1	TLPHC-001V-18P
Flange		7	25.6	TLPHC-001V-07P	19	67.6	TLPHC-001V-19P
Join	Solid body non stackable	8	29.1	TLPHC-001V-08P	20	71.1	TLPHC-001V-20P
Colour	Green or Black	9	32.6	TLPHC-001V-09P	21	74.6	TLPHC-001V-21P
Current	8A (UL) / 10A (VDE)	10	36.1	TLPHC-001V-10P	22	78.1	TLPHC-001V-22P
Voltage	300V (UL) / 150V (VDE)	11	39.6	TLPHC-001V-11P	23	81.6	TLPHC-001V-23P
Approval Bodies		12	43.1	TLPHC-001V-12P	24	85.1	TLPHC-001V-24P
		13	46.6	TLPHC-001V-13P			

TLPHC-001R-xxP

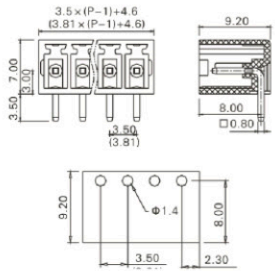

2-24 Pole PCB mount - Male header Wave - through hole Horizontal 3.5mm pitch

		N° of Poles	Pole Length (mm)	Product Code	N° of Poles	Pole Length (mm)	Product Code
Pitch (mm)	3.5	2	8.1	TLPHC-001R-02P	14	50.1	TLPHC-001R-14P
PCB Hole Ø	1.4	3	11.6	TLPHC-001R-03P	15	53.6	TLPHC-001R-15P
Orientation	Horizontal	4	15.1	TLPHC-001R-04P	16	57.1	TLPHC-001R-16P
Mount Type	Wave - Through Hole	5	18.6	TLPHC-001R-05P	17	60.6	TLPHC-001R-17P
Screw	Slot Screw	6	22.1	TLPHC-001R-06P	18	64.1	TLPHC-001R-18P
Flange		7	25.6	TLPHC-001R-07P	19	67.6	TLPHC-001R-19P
Join	Solid body non stackable	8	29.1	TLPHC-001R-08P	20	71.1	TLPHC-001R-20P
Colour	Green or Black	9	32.6	TLPHC-001R-09P	21	74.6	TLPHC-001R-21P
Current	8A (UL) / 10A (VDE)	10	36.1	TLPHC-001R-10P	22	78.1	TLPHC-001R-22P
Voltage	300V (UL) / 150V (VDE)	11	39.6	TLPHC-001R-11P	23	81.6	TLPHC-001R-23P
Approval Bodies		12	43.1	TLPHC-001R-12P	24	85.1	TLPHC-001R-24P
		13	46.6	TLPHC-001R-13P			

TLPHW-001R-xxP

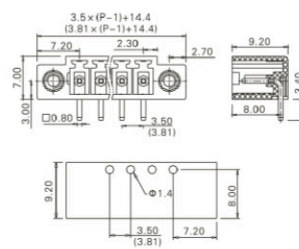

2-24 Pole PCB mount - Male header Wave - through hole Horizontal 3.5mm pitch

		N° of Poles	Pole Length (mm)	Product Code	N° of Poles	Pole Length (mm)	Product Code
Pitch (mm)	3.5	2	17.9	TLPHW-001R-02P	14	59.9	TLPHW-001R-14P
PCB Hole Ø	1.4	3	21.4	TLPHW-001R-03P	15	63.4	TLPHW-001R-15P
Orientation	Horizontal	4	24.9	TLPHW-001R-04P	16	66.9	TLPHW-001R-16P
Mount Type	Wave - Through Hole	5	28.4	TLPHW-001R-05P	17	70.4	TLPHW-001R-17P
Screw		6	31.9	TLPHW-001R-06P	18	73.9	TLPHW-001R-18P
Flange	With Flange	7	35.4	TLPHW-001R-07P	19	77.4	TLPHW-001R-19P
Join	Solid body non stackable	8	38.9	TLPHW-001R-08P	20	80.9	TLPHW-001R-20P
Colour	Green or Black	9	42.4	TLPHW-001R-09P	21	84.4	TLPHW-001R-21P
Current	8A (UL) / 10A (VDE)	10	45.9	TLPHW-001R-10P	22	87.9	TLPHW-001R-22P
Voltage	300V (UL) / 150V (VDE)	11	49.4	TLPHW-001R-11P	23	91.4	TLPHW-001R-23P
Approval Bodies		12	52.9	TLPHW-001R-12P	24	94.9	TLPHW-001R-24P
		13	56.4	TLPHW-001R-13P			

Features:

- Standard colour options include Green or Black

TLPHW-001V-xxP

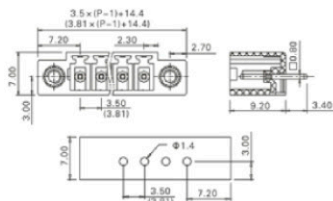

2-24 Pole PCB mount - Male header
 Wave - through hole Vertical 3.5mm pitch

		N° of Poles	Pole Length (mm)	Product Code	N° of Poles	Pole Length (mm)	Product Code
Pitch (mm)	3.5	2	17.9	TLPHW-001V-02P	14	59.9	TLPHW-001V-14P
PCB Hole Ø	1.4	3	21.4	TLPHW-001V-03P	15	63.4	TLPHW-001V-15P
Orientation	Vertical	4	24.9	TLPHW-001V-04P	16	66.9	TLPHW-001V-16P
Mount Type	Wave - Through Hole	5	28.4	TLPHW-001V-05P	17	70.4	TLPHW-001V-17P
Screw		6	31.9	TLPHW-001V-06P	18	73.9	TLPHW-001V-18P
Flange	With Flange	7	35.4	TLPHW-001V-07P	19	77.4	TLPHW-001V-19P
Join	Solid body non stackable	8	38.9	TLPHW-001V-08P	20	80.9	TLPHW-001V-20P
Colour	Green or Black	9	42.4	TLPHW-001V-09P	21	84.4	TLPHW-001V-21P
Current	8A (UL) / 10A (VDE)	10	45.9	TLPHW-001V-10P	22	87.9	TLPHW-001V-22P
Voltage	300V (UL) / 150V (VDE)	11	49.4	TLPHW-001V-11P	23	91.4	TLPHW-001V-23P
Approval Bodies		12	52.9	TLPHW-001V-12P	24	94.9	TLPHW-001V-24P
		13	56.4	TLPHW001V-13P			

TLPHC-104-xxP

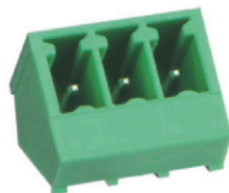
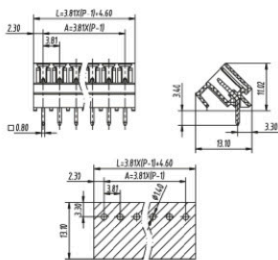

2-24 Pole Pluggable type 45 degree
 45 degree 3.81mm pitch

		N° of Poles	Pole Length (mm)	Product Code	N° of Poles	Pole Length (mm)	Product Code
Pitch (mm)	3.81	2	8.41	TLPHC-104-02P	14	54.13	TLPHC-104-14P
PCB Hole Ø	1.4	3	12.22	TLPHC-104-03P	15	57.94	TLPHC-104-15P
Orientation	45 degree	4	16.03	TLPHC-104-04P	16	61.75	TLPHC-104-16P
Mount Type	45 degree	5	19.84	TLPHC-104-05P	17	65.56	TLPHC-104-17P
Screw	Slot Screw	6	23.65	TLPHC-104-06P	18	69.37	TLPHC-104-18P
Flange		7	27.46	TLPHC-104-07P	19	73.18	TLPHC-104-19P
Join	Solid body non stackable	8	31.27	TLPHC-104-08P	20	76.99	TLPHC-104-20P
Colour	Green or Black	9	35.08	TLPHC-104-09P	21	80.8	TLPHC-104-21P
Current	10A	10	38.89	TLPHC-104-10P	22	84.61	TLPHC-104-22P
Voltage	300V	11	42.7	TLPHC-104-11P	23	88.42	TLPHC-104-23P
Approval Bodies		12	46.51	TLPHC-104-12P	24	92.23	TLPHC-104-24P
		13	50.32	TLPHC-104-13P			

TLPHW-100R-xxP

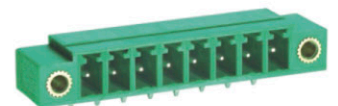
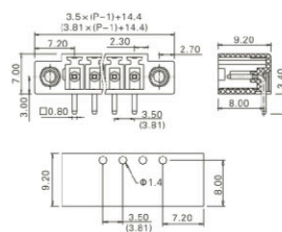

2-24 Pole PCB mount - Male header Wave -
 through hole Horizontal 3.81mm pitch

		N° of Poles	Pole Length (mm)	Product Code	N° of Poles	Pole Length (mm)	Product Code
Pitch (mm)	3.81	2	18.21	TLPHW-100R-02P	14	63.93	TLPHW-100R-14P
PCB Hole Ø	1.4	3	22.02	TLPHW-100R-03P	15	67.74	TLPHW-100R-15P
Orientation	Horizontal	4	25.83	TLPHW-100R-04P	16	71.55	TLPHW-100R-16P
Mount Type	Wave - Through Hole	5	29.64	TLPHW-100R-05P	17	75.36	TLPHW-100R-17P
Screw		6	33.45	TLPHW-100R-06P	18	79.17	TLPHW-100R-18P
Flange	With Flange	7	37.26	TLPHW-100R-07P	19	82.98	TLPHW-100R-19P
Join	Solid body non stackable	8	41.07	TLPHW-100R-08P	20	86.79	TLPHW-100R-20P
Colour	Green or Black	9	44.88	TLPHW-100R-09P	21	90.6	TLPHW-100R-21P
Current	8A (UL) / 10A (VDE)	10	48.69	TLPHW-100R-10P	22	94.41	TLPHW-100R-22P
Voltage	300V (UL) / 150V (VDE)	11	52.5	TLPHW-100R-11P	23	98.22	TLPHW-100R-23P
Approval Bodies		12	56.31	TLPHW-100R-12P	24	102.03	TLPHW-100R-24P
		13	60.12	TLPHW-100R-13P			

*xx = number of poles

PCB TERMINAL BLOCKS - PLUGGABLE PIN HEADER (MALE) - SINGLE ROW PCB HEADER

TLPHC-100R-xxP

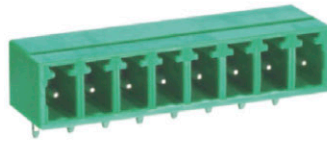
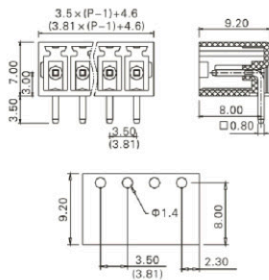

2-24 Pole PCB mount - Male header Wave - through hole Vertical 3.81mm pitch

		N° of Poles	Pole Length (mm)	Product Code	N° of Poles	Pole Length (mm)	Product Code
Pitch (mm)	3.81	2	8.41	TLPHC-100R-02P	14	54.13	TLPHC-100R-14P
PCB Hole Ø	1.4	3	12.22	TLPHC-100R-03P	15	57.94	TLPHC-100R-15P
Orientation	Horizontal	4	16.03	TLPHC-100R-04P	16	61.75	TLPHC-100R-16P
Mount Type	Wave - Through Hole	5	19.84	TLPHC-100R-05P	17	65.56	TLPHC-100R-17P
Screw	Slot Screw	6	23.65	TLPHC-100R-06P	18	69.37	TLPHC-100R-18P
Flange		7	27.46	TLPHC-100R-07P	19	73.18	TLPHC-100R-19P
Join	Solid body non stackable	8	31.27	TLPHC-100R-08P	20	76.99	TLPHC-100R-20P
Colour	Green or Black	9	35.08	TLPHC-100R-09P	21	80.8	TLPHC-100R-21P
Current	8A (UL) / 10A (VDE)	10	38.89	TLPHC-100R-10P	22	84.61	TLPHC-100R-22P
Voltage	300V (UL) / 150V (VDE)	11	42.7	TLPHC-100R-11P	23	88.42	TLPHC-100R-23P
Approval Bodies		12	46.51	TLPHC-100R-12P	24	92.23	TLPHC-100R-24P
		13	50.32	TLPHC-100R-13P			

TLPHC-100V-xxP

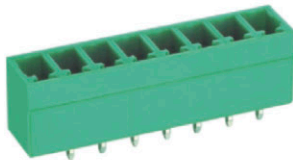
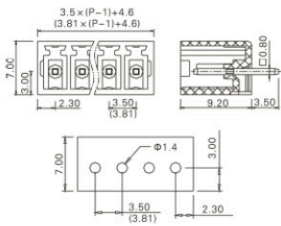

2-24 Pole PCB mount - Male header Wave - through hole Vertical 3.81mm pitch

		N° of Poles	Pole Length (mm)	Product Code	N° of Poles	Pole Length (mm)	Product Code
Pitch (mm)	3.81	2	8.41	TLPHC-100V-02P	14	54.13	TLPHC-100V-14P
PCB Hole Ø	1.4	3	12.22	TLPHC-100V-03P	15	57.94	TLPHC-100V-15P
Orientation	Vertical	4	16.03	TLPHC-100V-04P	16	61.75	TLPHC-100V-16P
Mount Type	Wave - Through Hole	5	19.84	TLPHC-100V-05P	17	65.56	TLPHC-100V-17P
Screw	Slot Screw	6	23.65	TLPHC-100V-06P	18	69.37	TLPHC-100V-18P
Flange		7	27.46	TLPHC-100V-07P	19	73.18	TLPHC-100V-19P
Join	Solid body non stackable	8	31.27	TLPHC-100V-08P	20	76.99	TLPHC-100V-20P
Colour	Green or Black	9	35.08	TLPHC-100V-09P	21	80.8	TLPHC-100V-21P
Current	8A (UL) / 10A (VDE)	10	38.89	TLPHC-100V-10P	22	84.61	TLPHC-100V-22P
Voltage	300V (UL) / 150V (VDE)	11	42.7	TLPHC-100V-11P	23	88.42	TLPHC-100V-23P
Approval Bodies		12	46.51	TLPHC-100V-12P	24	92.23	TLPHC-100V-24P
		13	50.32	TLPHC-100V-13P			

TLPHW-100V-xxP

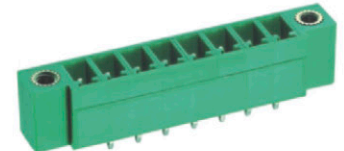
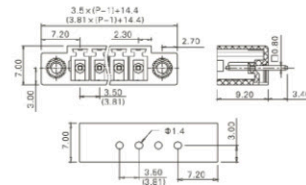

2-24 Pole PCB mount - Male header Wave - through hole Vertical 3.81mm pitch

		N° of Poles	Pole Length (mm)	Product Code	N° of Poles	Pole Length (mm)	Product Code
Pitch (mm)	3.81	2	18.21	TLPHW-100V-02P	14	63.93	TLPHW-100V-14P
PCB Hole Ø	1.4	3	22.02	TLPHW-100V-03P	15	67.74	TLPHW-100V-15P
Orientation	Vertical	4	25.83	TLPHW-100V-04P	16	71.55	TLPHW-100V-16P
Mount Type	Wave - Through Hole	5	29.64	TLPHW-100V-05P	17	75.36	TLPHW-100V-17P
Screw		6	33.45	TLPHW-100V-06P	18	79.17	TLPHW-100V-18P
Flange	With Flange	7	37.26	TLPHW-100V-07P	19	82.98	TLPHW-100V-19P
Join	Solid body non stackable	8	41.07	TLPHW-100V-08P	20	86.79	TLPHW-100V-20P
Colour	Green or Black	9	44.88	TLPHW-100V-09P	21	90.6	TLPHW-100V-21P
Current	8A (UL) / 10A (VDE)	10	48.69	TLPHW-100V-10P	22	94.41	TLPHW-100V-22P
Voltage	300V (UL) / 150V (VDE)	11	52.5	TLPHW-100V-11P	23	98.22	TLPHW-100V-23P
Approval Bodies		12	56.31	TLPHW-100V-12P	24	102.03	TLPHW-100V-24P
		13	60.12	TLPHW-100V-13P			

Features:

- Standard colour options include Green or Black

2-36 Pole Pluggable type Vertical 5mm pitch

TLPH-225-xxP

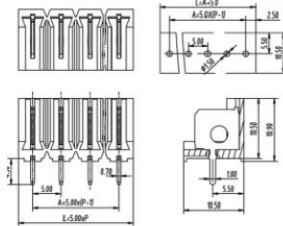

2-36 Pole Pluggable type Vertical 5mm pitch

		N° of Poles	Pole Length (mm)	Product Code	N° of Poles	Pole Length (mm)	Product Code	N° of Poles	Pole Length (mm)	Product Code
Pitch (mm)	5	2	10	TLPH-225-02P	15	75	TLPH-225-15P	28	140	TLPH-225-22P
PCB Hole Ø	1.3-1.5	3	15	TLPH-225-03P	16	80	TLPH-225-16P	29	145	TLPH-225-23P
Orientation	Vertical	4	20	TLPH-225-04P	17	85	TLPH-225-17P	30	150	TLPH-225-24P
Mount Type	Vertical	5	25	TLPH-225-05P	18	90	TLPH-225-18P	31	155	TLPH-225-20P
Screw		6	30	TLPH-225-06P	19	95	TLPH-225-19P	32	160	TLPH-225-21P
Flange		7	35	TLPH-225-07P	20	100	TLPH-225-20P	33	165	TLPH-225-22P
Join	Solid body non stackable	8	40	TLPH-225-08P	21	105	TLPH-225-21P	34	170	TLPH-225-23P
Colour	Grey	9	45	TLPH-225-09P	22	110	TLPH-225-22P	35	175	TLPH-225-24P
Length (mm)		10	50	TLPH-225-10P	23	115	TLPH-225-23P	36	180	TLPH-225-24P
Current	15A	11	55	TLPH-225-11P	24	120	TLPH-225-24P			
Voltage	300V	12	60	TLPH-225-12P	25	125	TLPH-225-19P			
Approval Bodies		13	65	TLPH-225-13P	26	130	TLPH-225-20P			
		14	70	TLPH-225-14P	27	135	TLPH-225-21P			

TLPH-200R-xxP

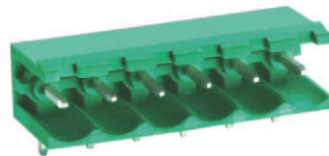
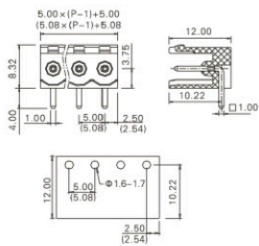

2-24 Pole PCB mount - Male header Wave - through hole Horizontal 5mm pitch

		N° of Poles	Pole Length (mm)	Product Code	N° of Poles	Pole Length (mm)	Product Code
Pitch (mm)	5	2	10	TLPH-200R-02P	14	70	TLPH-200R-14P
PCB Hole Ø	1.6-1.7	3	15	TLPH-200R-03P	15	75	TLPH-200R-15P
Orientation	Horizontal	4	20	TLPH-200R-04P	16	80	TLPH-200R-16P
Mount Type	Wave - Through Hole	5	25	TLPH-200R-05P	17	85	TLPH-200R-17P
Screw	Standard	6	30	TLPH-200R-06P	18	90	TLPH-200R-18P
Flange		7	35	TLPH-200R-07P	19	95	TLPH-200R-19P
Join	Solid body non stackable	8	40	TLPH-200R-08P	20	100	TLPH-200R-20P
Colour	Green or Black	9	45	TLPH-200R-09P	21	105	TLPH-200R-21P
Current	16A (UL) / 15A (VDE)	10	50	TLPH-200R-10P	22	110	TLPH-200R-22P
Voltage	300V (UL) / 250V (VDE)	11	55	TLPH-200R-11P	23	115	TLPH-200R-23P
Approval Bodies		12	60	TLPH-200R-12P	24	120	TLPH-200R-24P
		13	65	TLPH-200R-13P			

TLPHW-200R-xxP

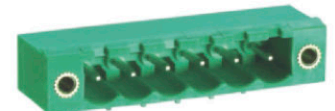
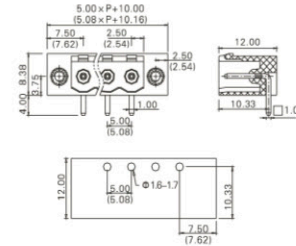

2-24 Pole PCB mount - Male header Wave - through hole Horizontal 5mm pitch

		N° of Poles	Pole Length (mm)	Product Code	N° of Poles	Pole Length (mm)	Product Code
Pitch (mm)	5	2	20	TLPHW-200R-02P	14	80	TLPHW-200R-14P
PCB Hole Ø	1.6-1.7	3	25	TLPHW-200R-03P	15	85	TLPHW-200R-15P
Orientation	Horizontal	4	30	TLPHW-200R-04P	16	90	TLPHW-200R-16P
Mount Type	Wave - Through Hole	5	35	TLPHW-200R-05P	17	95	TLPHW-200R-17P
Screw		6	40	TLPHW-200R-06P	18	100	TLPHW-200R-18P
Flange	With Flange	7	45	TLPHW-200R-07P	19	105	TLPHW-200R-19P
Join	Solid body non stackable	8	50	TLPHW-200R-08P	20	110	TLPHW-200R-20P
Colour	Green or Black	9	55	TLPHW-200R-09P	21	115	TLPHW-200R-21P
Current	16A (UL) / 15A (VDE)	10	60	TLPHW-200R-10P	22	120	TLPHW-200R-22P
Voltage	300V (UL) / 250V (VDE)	11	65	TLPHW-200R-11P	23	125	TLPHW-200R-23P
Approval Bodies		12	70	TLPHW-200R-12P	24	130	TLPHW-200R-24P
		13	75	TLPHW-200R-13P			

*xx = number of poles

PCB TERMINAL BLOCKS - PLUGGABLE PIN HEADER (MALE) - SINGLE ROW PCB HEADER

TLPHC-200R-xxP

2-24 Pole PCB mount - Male header Wave - through hole Vertical 5mm pitch

	N° of Poles	Pole Length (mm)	Product Code	N° of Poles	Pole Length (mm)	Product Code
Pitch (mm)	5					
PCB Hole Ø	1.6-1.7					
Orientation	Vertical					
Mount Type	Wave - Through Hole					
Screw	Slot Screw					
Flange						
Join	Solid body non stackable					
Colour	Green or Black					
UL (Rated)	16A (UL) / 15A (VDE)					
Voltage	300V (UL) / 250V (VDE)					
Approval Bodies						

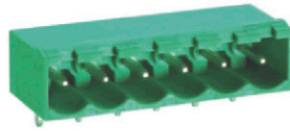
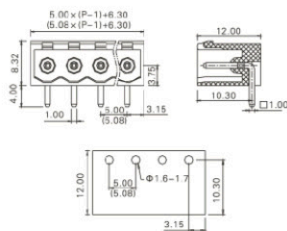

TLPH-200V-xxP

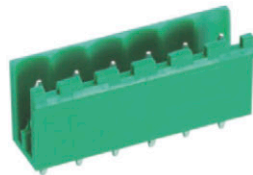
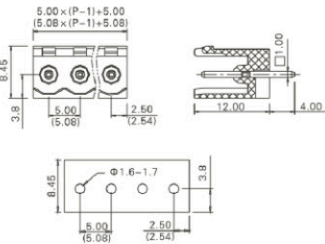

2-24 Pole PCB mount - Male header Wave - through hole Vertical 5mm pitch

	N° of Poles	Pole Length (mm)	Product Code	N° of Poles	Pole Length (mm)	Product Code
Pitch (mm)	5					
PCB Hole Ø	1.6-1.7					
Orientation	Vertical					
Mount Type	Wave - Through Hole					
Screw						
Flange						
Join	Solid body non stackable					
Colour	Green or Black					
Current	16A (UL) / 15A (VDE)					
Voltage	300V (UL) / 250V (VDE)					
Approval Bodies						

TLPHC-200V-xxP

2-24 Pole PCB mount - Male header Wave - through hole Vertical 5mm pitch

	N° of Poles	Pole Length (mm)	Product Code	N° of Poles	Pole Length (mm)	Product Code
Pitch (mm)	5					
PCB Hole Ø	1.6-1.7					
Orientation	Vertical					
Mount Type	Wave - Through Hole					
Screw	Slot Screw					
Flange						
Join	Solid body non stackable					
Colour	Green or Black					
Current	16A (UL) / 15A (VDE)					
Voltage	300V (UL) / 250V (VDE)					
Approval Bodies						

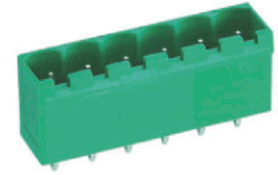
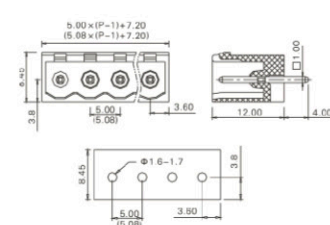

Features:

- Standard colour options include Green or Black

TLPHW-200V-xxP

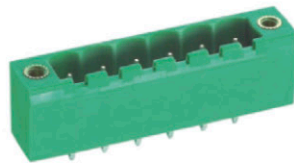
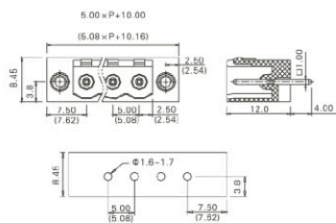

2-24 Pole PCB mount - Male header Wave - through hole Vertical 5mm pitch

	N° of Poles	Pole Length (mm)	Product Code	N° of Poles	Pole Length (mm)	Product Code	
Pitch (mm)	5	2	20	TLPHW-200V-02P	14	80	TLPHW-200V-14P
PCB Hole Ø	1.6-1.7	3	25	TLPHW-200V-03P	15	85	TLPHW-200V-15P
Orientation	Vertical	4	30	TLPHW-200V-04P	16	90	TLPHW-200V-16P
Mount Type	Wave - Through Hole	5	35	TLPHW-200V-05P	17	95	TLPHW-200V-17P
Screw		6	40	TLPHW-200V-06P	18	100	TLPHW-200V-18P
Flange	With Flange	7	45	TLPHW-200V-07P	19	105	TLPHW-200V-19P
Join	Solid body non stackable	8	50	TLPHW-200V-08P	20	110	TLPHW-200V-20P
Colour	Green or Black	9	55	TLPHW-200V-09P	21	115	TLPHW-200V-21P
Current	16A (UL) / 15A (VDE)	10	60	TLPHW-200V-10P	22	120	TLPHW-200V-22P
Voltage	300V (UL) / 50V (VDE)	11	65	TLPHW-200V-11P	23	125	TLPHW-200V-23P
Approval Bodies		12	70	TLPHW-200V-12P	24	130	TLPHW-200V-24P
		13	75	TLPHW-200V-13P			

TL205P-xxPK

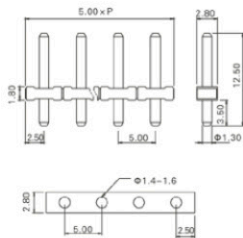

2-24 Pole PCB mount - Male header Wave - through hole Vertical 5mm pitch

	N° of Poles	Pole Length (mm)	Product Code	N° of Poles	Pole Length (mm)	Product Code	
Pitch (mm)	5	2	10	TL205P-02PK	14	70	TL205P-02PK
PCB Hole Ø	1.4-1.6	3	15	TL205P-02PK	15	75	TL205P-02PK
Orientation	Vertical	4	20	TL205P-02PK	16	80	TL205P-02PK
Mount Type	Wave - Through Hole	5	25	TL205P-02PK	17	85	TL205P-02PK
Screw	Slot Screw	6	30	TL205P-02PK	18	90	TL205P-02PK
Flange		7	35	TL205P-02PK	19	95	TL205P-02PK
Join	Solid body non stackable	8	40	TL205P-02PK	20	100	TL205P-02PK
Colour	Green or Black	9	45	TL205P-02PK	21	105	TL205P-02PK
Current	10A	10	50	TL205P-02PK	22	110	TL205P-02PK
Voltage	300V	11	55	TL205P-02PK	23	115	TL205P-02PK
Approval Bodies		12	60	TL205P-02PK	24	120	TL205P-02PK
		13	65	TL205P-02PK			

TLPHW-300R-0544-xxP

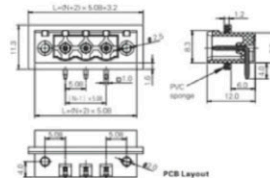

2-36 Pole Pluggable type Horizontal 5.08mm pitch

	N° of Poles	Pole Length (mm)	Product Code	N° of Poles	Pole Length (mm)	Product Code
	2	13.36	TLPHW-300R-0544-02P	20	104.8	TLPHW-300R-0544-20P
	3	18.44	TLPHW-300R-0544-03P	21	109.88	TLPHW-300R-0544-21P
	4	23.52	TLPHW-300R-0544-04P	22	114.96	TLPHW-300R-0544-22P
	5	28.6	TLPHW-300R-0544-05P	23	120.04	TLPHW-300R-0544-23P
	6	33.68	TLPHW-300R-0544-06P	24	125.12	TLPHW-300R-0544-24P
Pitch (mm)	5.08	7	38.76	TLPHW-300R-0544-07P	25	TLPHW-300R-0544-25P
Wire Size (mm²)		8	43.84	TLPHW-300R-0544-08P	26	TLPHW-300R-0544-26P
PCB Hole Ø	1.6-1.7	9	48.92	TLPHW-300R-0544-09P	27	TLPHW-300R-0544-27P
Orientation	Horizontal	10	54	TLPHW-300R-0544-10P	28	TLPHW-300R-0544-28P
Mount Type	Horizontal	11	59.08	TLPHW-300R-0544-11P	29	TLPHW-300R-0544-29P
Screw		12	64.16	TLPHW-300R-0544-12P	30	TLPHW-300R-0544-30P
Flange		13	69.24	TLPHW-300R-0544-13P	31	TLPHW-300R-0544-31P
Join	Solid body non stackable	14	74.32	TLPHW-300R-0544-14P	32	TLPHW-300R-0544-32P
Colour	Grey	15	79.4	TLPHW-300R-0544-15P	33	TLPHW-300R-0544-33P
Length (mm)		16	84.48	TLPHW-300R-0544-16P	34	TLPHW-300R-0544-34P
Current	15A	17	89.56	TLPHW-300R-0544-17P	35	TLPHW-300R-0544-35P
Voltage	300V	18	94.64	TLPHW-300R-0544-18P	36	TLPHW-300R-0544-36P
Approval Bodies		19	99.72	TLPHW-300R-0544-19P		

*xx = number of poles

PCB TERMINAL BLOCKS - PLUGGABLE PIN HEADER (MALE) - SINGLE ROW PCB HEADER

TLPH-300R-xxP

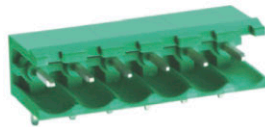
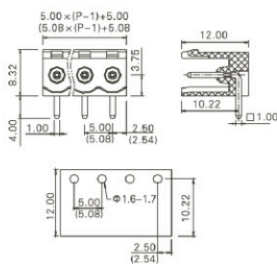

2-24 Pole PCB mount - Male header Wave - through hole Horizontal 5.08mm pitch

		N° of Poles	Pole Length (mm)	Product Code	N° of Poles	Pole Length (mm)	Product Code
Pitch (mm)	5.08	2	10.16	TLPH-300R-02P	14	71.12	TLPH-300R-14P
PCB Hole Ø	1.6-1.7	3	15.24	TLPH-300R-03P	15	76.2	TLPH-300R-15P
Orientation	Horizontal	4	20.32	TLPH-300R-04P	16	81.28	TLPH-300R-16P
Mount Type	Wave - Through Hole	5	25.4	TLPH-300R-05P	17	86.36	TLPH-300R-17P
Screw		6	30.48	TLPH-300R-06P	18	91.44	TLPH-300R-18P
Flange		7	35.56	TLPH-300R-07P	19	96.52	TLPH-300R-19P
Join	Solid body non stackable	8	40.64	TLPH-300R-08P	20	101.6	TLPH-300R-20P
Colour	Green or Black	9	45.72	TLPH-300R-09P	21	106.68	TLPH-300R-21P
Current	16A (UL) / 15A (VDE)	10	50.8	TLPH-300R-10P	22	111.76	TLPH-300R-22P
Voltage	300V (UL) / 250V (VDE)	11	55.88	TLPH-300R-11P	23	116.84	TLPH-300R-23P
Approval Bodies		12	60.96	TLPH-300R-12P	24	121.92	TLPH-300R-24P
		13	66.04	TLPH-300R-13P			

TLPHC-300R-xxP

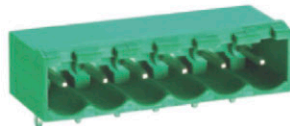
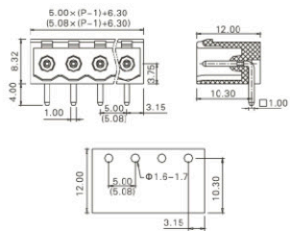

2-24 Pole PCB mount - Male header Wave - through hole Horizontal 5.08mm pitch

		N° of Poles	Pole Length (mm)	Product Code	N° of Poles	Pole Length (mm)	Product Code
Pitch (mm)	5.08	2	11.38	TLPHC-300R-02P	14	72.34	TLPHC-300R-14P
PCB Hole Ø	1.6-1.7	3	16.46	TLPHC-300R-03P	15	77.42	TLPHC-300R-15P
Orientation	Horizontal	4	21.54	TLPHC-300R-04P	16	82.5	TLPHC-300R-16P
Mount Type	Wave - Through Hole	5	26.62	TLPHC-300R-05P	17	87.58	TLPHC-300R-17P
Screw	Slot Screw	6	31.7	TLPHC-300R-06P	18	92.66	TLPHC-300R-18P
Flange		7	36.78	TLPHC-300R-07P	19	97.74	TLPHC-300R-19P
Join	Solid body non stackable	8	41.86	TLPHC-300R-08P	20	102.82	TLPHC-300R-20P
Colour	Green or Black	9	46.94	TLPHC-300R-09P	21	107.9	TLPHC-300R-21P
Current	16A (UL) / 15A (VDE)	10	52.02	TLPHC-300R-10P	22	112.98	TLPHC-300R-22P
Voltage	300V (UL) / 250V (VDE)	11	57.1	TLPHC-300R-11P	23	118.06	TLPHC-300R-23P
Approval Bodies		12	62.18	TLPHC-300R-12P	24	123.14	TLPHC-300R-24P
		13	67.26	TLPHC-300R-13P			

TLPHDC-300R-xxP

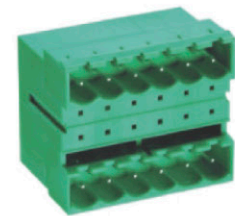
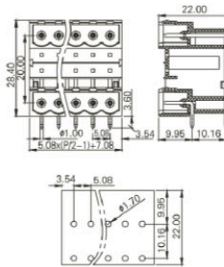

4-24 Pole PCB mount - Male header Wave - through hole Horizontal 5.08mm pitch

		N° of Poles	Pole Length (mm)	Product Code	N° of Poles	Pole Length (mm)	Product Code
Pitch (mm)	5.08	4	12.88	TLPHDC-300R-04P			
PCB Hole Ø	1.6-1.7	6	17.96	TLPHDC-300R-06P			
Orientation	Horizontal	8	23.04	TLPHDC-300R-08P			
Mount Type	Wave - Through Hole	10	28.12	TLPHDC-300R-10P			
Screw	Slot Screw	12	33.2	TLPHDC-300R-12P			
Flange		14	38.28	TLPHDC-300R-14P			
Join	Solid body non stackable	16	43.36	TLPHDC-300R-16P			
Colour	Green or Black	18	48.44	TLPHDC-300R-18P			
Current	12A	20	53.52	TLPHDC-300R-20P			
Voltage	300V	22	58.6	TLPHDC-300R-22P			
Approval Bodies		24	63.68	TLPHDC-300R-24P			

Features:

- Standard colour options include Green or Black

TLPHW-300R-xxP

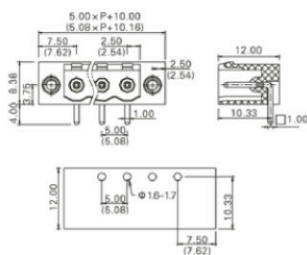

2-24 Pole PCB mount - Male header Wave - through hole Horizontal 5.08mm pitch

	N° of Poles	Pole Length (mm)	Product Code	N° of Poles	Pole Length (mm)	Product Code	
Pitch (mm)	5.08	2	20.32	TLPHW-300R-02P	14	81.28	TLPHW-300R-14P
PCB Hole Ø	1.6-1.7	3	25.4	TLPHW-300R-03P	15	86.36	TLPHW-300R-15P
Orientation	Horizontal	4	30.48	TLPHW-300R-04P	16	91.44	TLPHW-300R-16P
Mount Type	Wave - Through Hole	5	35.56	TLPHW-300R-05P	17	96.52	TLPHW-300R-17P
Screw		6	40.64	TLPHW-300R-06P	18	101.6	TLPHW-300R-18P
Flange	With Flange	7	45.72	TLPHW-300R-07P	19	106.68	TLPHW-300R-19P
Join	Solid body non stackable	8	50.8	TLPHW-300R-08P	20	111.76	TLPHW-300R-20P
Colour	Green or Black	9	55.88	TLPHW-300R-09P	21	116.84	TLPHW-300R-21P
Current	16A (UL) / 15A (VDE)	10	60.96	TLPHW-300R-10P	22	121.92	TLPHW-300R-22P
Voltage	300V (UL) / 250V (VDE)	11	66.04	TLPHW-300R-11P	23	127	TLPHW-300R-23P
Approval Bodies		12	71.12	TLPHW-300R-12P	24	132.08	TLPHW-300R-24P
		13	76.2	TLPHW-300R-13P			

TLPH-300V-xxP

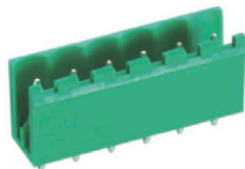
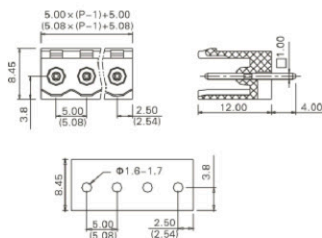

TLPHC-300V-xxP

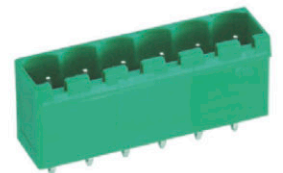
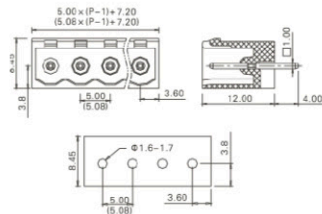

2-24 Pole PCB mount - Male header Wave - through hole Vertical 5.08mm pitch

	N° of Poles	Pole Length (mm)	Product Code	N° of Poles	Pole Length (mm)	Product Code	
Pitch (mm)	5.08	2	10.16	TLPH-300V-02P	14	71.12	TLPH-300V-14P
PCB Hole Ø	1.6-1.7	3	15.24	TLPH-300V-03P	15	78.32	TLPH-300V-15P
Orientation	Vertical	4	20.32	TLPH-300V-04P	16	83.4	TLPH-300V-16P
Mount Type	Wave - Through Hole	5	25.4	TLPH-300V-05P	17	88.48	TLPH-300V-17P
Screw		6	30.48	TLPH-300V-06P	18	93.56	TLPH-300V-18P
Flange		7	35.56	TLPH-300V-07P	19	98.64	TLPH-300V-19P
Join	Solid body non stackable	8	40.64	TLPH-300V-08P	20	103.72	TLPH-300V-20P
Colour	Green or Black	9	45.72	TLPH-300V-09P	21	108.8	TLPH-300V-21P
Current	16A (UL) / 15A (VDE)	10	50.8	TLPH-300V-10P	22	113.88	TLPH-300V-22P
Voltage	300V (UL) / 250V (VDE)	11	55.88	TLPH-300V-11P	23	118.96	TLPH-300V-23P
Approval Bodies		12	60.96	TLPH-300V-12P	24	124.04	TLPH-300V-24P
		13	66.04	TLPH-300V-13P			

2-24 Pole PCB mount - Male header Wave - through hole Vertical 5.08mm pitch

	N° of Poles	Pole Length (mm)	Product Code	N° of Poles	Pole Length (mm)	Product Code	
Pitch (mm)	5.08	2	12.28	TLPHC-300V-02P	14	73.24	TLPHC-300V-14P
PCB Hole Ø	1.6-1.7	3	17.36	TLPHC-300V-03P	15	76.2	TLPHC-300V-15P
Orientation	Vertical	4	22.44	TLPHC-300V-04P	16	81.28	TLPHC-300V-16P
Mount Type	Wave - Through Hole	5	27.52	TLPHC-300V-05P	17	86.36	TLPHC-300V-17P
Screw	Slot Screw	6	32.6	TLPHC-300V-06P	18	91.44	TLPHC-300V-18P
Flange		7	37.68	TLPHC-300V-07P	19	96.52	TLPHC-300V-19P
Join	Solid body non stackable	8	42.76	TLPHC-300V-08P	20	101.6	TLPHC-300V-20P
Colour	Green or Black	9	47.84	TLPHC-300V-09P	21	106.68	TLPHC-300V-21P
Current	16A (UL) / 15A (VDE)	10	52.92	TLPHC-300V-10P	22	111.76	TLPHC-300V-22P
Voltage	300V (UL) / 250V (VDE)	11	58	TLPHC-300V-11P	23	116.84	TLPHC-300V-23P
Approval Bodies		12	63.08	TLPHC-300V-12P	24	121.92	TLPHC-300V-24P
		13	68.16	TLPHC-300V-13P			

*xx = number of poles

PCB TERMINAL BLOCKS - PLUGGABLE PIN HEADER (MALE) - SINGLE ROW PCB HEADER

TLPHW-300V-xxP

2-24 Pole PCB mount - Male header Wave - through hole Vertical 5.08mm pitch

	N° of Poles	Pole Length (mm)	Product Code	N° of Poles	Pole Length (mm)	Product Code	
Pitch (mm)	5.08	2	20.32	TLPHW-300V-02P	14	81.28	TLPHW-300V-14P
PCB Hole Ø	1.6-1.7	3	25.4	TLPHW-300V-03P	15	86.36	TLPHW-300V-15P
Orientation	Vertical	4	30.48	TLPHW-300V-04P	16	91.44	TLPHW-300V-16P
Mount Type	Wave - Through Hole	5	35.56	TLPHW-300V-05P	17	96.52	TLPHW-300V-17P
Screw		6	40.64	TLPHW-300V-06P	18	101.6	TLPHW-300V-18P
Flange	With Flange	7	45.72	TLPHW-300V-07P	19	106.68	TLPHW-300V-19P
Join	Solid body non stackable	8	50.8	TLPHW-300V-08P	20	111.76	TLPHW-300V-20P
Colour	Green or Black	9	55.88	TLPHW-300V-09P	21	116.84	TLPHW-300V-21P
Current	16A (UL) / 15A (VDE)	10	60.96	TLPHW-300V-10P	22	121.92	TLPHW-300V-22P
Voltage	300V (UL) / 250V (VDE)	11	66.04	TLPHW-300V-11P	23	127	TLPHW-300V-23P
Approval Bodies		12	71.12	TLPHW-300V-12P	24	132.08	TLPHW-300V-24P
		13	76.2	TLPHW-300V-13P			

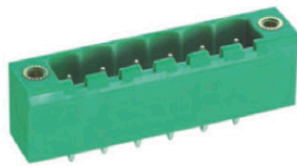
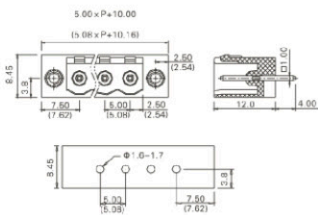

TLPH-400R-xxP

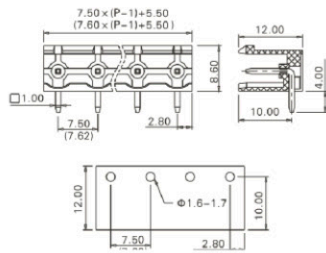

2-24 Pole PCB mount - Male header Wave - through hole Horizontal 7.5mm pitch

	N° of Poles	Pole Length (mm)	Product Code	N° of Poles	Pole Length (mm)	Product Code	
Pitch (mm)	7.5	2	13.1	TLPH-400R-02P	14	103.1	TLPH-400R-14P
PCB Hole Ø	1.6-1.7	3	20.6	TLPH-400R-03P	15	110.6	TLPH-400R-15P
Orientation	Horizontal	4	28.1	TLPH-400R-04P	16	118.1	TLPH-400R-16P
Mount Type	Wave - Through Hole	5	35.6	TLPH-400R-05P	17	125.6	TLPH-400R-17P
Screw		6	43.1	TLPH-400R-06P	18	133.1	TLPH-400R-18P
Flange		7	50.6	TLPH-400R-07P	19	140.6	TLPH-400R-19P
Join	Solid body non stackable	8	58.1	TLPH-400R-08P	20	148.1	TLPH-400R-20P
Colour	Green or Black	9	65.6	TLPH-400R-09P	21	155.6	TLPH-400R-21P
Current	16A (UL) / 15A (VDE)	10	73.1	TLPH-400R-10P	22	163.1	TLPH-400R-22P
Voltage	300V (UL) / 450V (VDE)	11	80.6	TLPH-400R-11P	23	170.6	TLPH-400R-23P
Approval Bodies		12	88.1	TLPH-400R-12P	24	178.1	TLPH-400R-24P
		13	95.6	TLPH-400R-13P			

TLPHC-400R-xxP

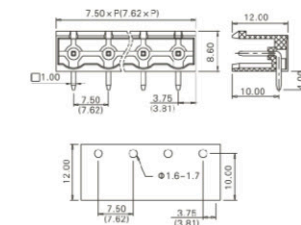

2-24 Pole PCB mount - Male header Wave - through hole Horizontal 7.5mm pitch

	N° of Poles	Pole Length (mm)	Product Code	N° of Poles	Pole Length (mm)	Product Code	
Pitch (mm)	7.5	2	15	TLPHC-400R-02P	14	105	TLPHC-400R-14P
PCB Hole Ø	1.6-1.7	3	22.5	TLPHC-400R-03P	15	112.5	TLPHC-400R-15P
Orientation	Horizontal	4	30	TLPHC-400R-04P	16	120	TLPHC-400R-16P
Mount Type	Wave - Through Hole	5	37.5	TLPHC-400R-05P	17	127.5	TLPHC-400R-17P
Screw	Slot Screw	6	45	TLPHC-400R-06P	18	135	TLPHC-400R-18P
Flange		7	52.5	TLPHC-400R-07P	19	142.5	TLPHC-400R-19P
Join	Solid body non stackable	8	60	TLPHC-400R-08P	20	150	TLPHC-400R-20P
Colour	Green or Black	9	67.5	TLPHC-400R-09P	21	157.5	TLPHC-400R-21P
Current	16A (UL) / 15A (VDE)	10	75	TLPHC-400R-10P	22	165	TLPHC-400R-22P
Voltage	300V (UL) / 450V (VDE)	11	82.5	TLPHC-400R-11P	23	172.5	TLPHC-400R-23P
Approval Bodies		12	90	TLPHC-400R-12P	24	180	TLPHC-400R-24P
		13	97.5	TLPHC-400R-13P			

*xx = number of poles

Features:

- Standard colour options include Green or Black

TLPHW-400R-xxP

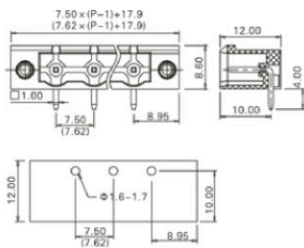

		N° of Poles	Pole Length (mm)	Product Code	N° of Poles	Pole Length (mm)	Product Code
Pitch (mm)	7.5	2	25.4	TLPHW-400R-02P	14	115.4	TLPHW-400R-14P
PCB Hole Ø	1.6-1.7	3	32.9	TLPHW-400R-03P	15	122.9	TLPHW-400R-15P
Orientation	Horizontal	4	40.4	TLPHW-400R-04P	16	130.4	TLPHW-400R-16P
Mount Type	Wave - Through Hole	5	47.9	TLPHW-400R-05P	17	137.9	TLPHW-400R-17P
Screw		6	55.4	TLPHW-400R-06P	18	145.4	TLPHW-400R-18P
Flange	With Flange	7	62.9	TLPHW-400R-07P	19	152.9	TLPHW-400R-19P
Join	Solid body non stackable	8	70.4	TLPHW-400R-08P	20	160.4	TLPHW-400R-20P
Colour	Green or Black	9	77.9	TLPHW-400R-09P	21	167.9	TLPHW-400R-21P
Current	16A (UL) / 15A (VDE)	10	85.4	TLPHW-400R-10P	22	175.4	TLPHW-400R-22P
Voltage	300V (UL) / 250V (VDE)	11	92.9	TLPHW-400R-11P	23	182.9	TLPHW-400R-23P
Approval Bodies		12	100.4	TLPHW-400R-12P	24	190.4	TLPHW-400R-24P
		13	107.9	TLPHW-400R-13P			

TLPH-400V-xxP

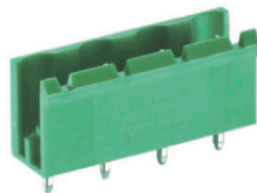
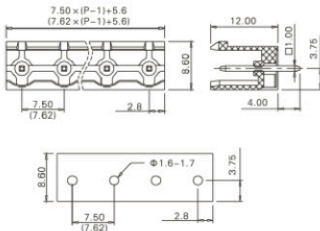

TLPHC-400V-xxP

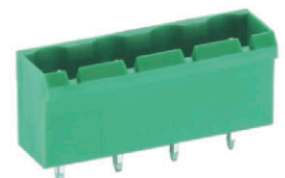
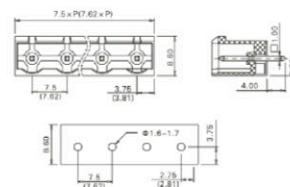

2-24 Pole PCB mount - Male header Wave - through hole Vertical 7.5mm pitch

		N° of Poles	Pole Length (mm)	Product Code	N° of Poles	Pole Length (mm)	Product Code
Pitch (mm)	7.5	2	13.1	TLPH-400V-02P	14	103.1	TLPH-400V-14P
PCB Hole Ø	1.6-1.7	3	20.6	TLPH-400V-03P	15	110.6	TLPH-400V-15P
Orientation	Vertical	4	28.1	TLPH-400V-04P	16	118.1	TLPH-400V-16P
Mount Type	Wave - Through Hole	5	35.6	TLPH-400V-05P	17	125.6	TLPH-400V-17P
Screw		6	43.1	TLPH-400V-06P	18	133.1	TLPH-400V-18P
Flange		7	50.6	TLPH-400V-07P	19	140.6	TLPH-400V-19P
Join	Solid body non stackable	8	58.1	TLPH-400V-08P	20	148.1	TLPH-400V-20P
Colour	Green or Black	9	65.6	TLPH-400V-09P	21	155.6	TLPH-400V-21P
Current	16A (UL) / 15A (VDE)	10	73.1	TLPH-400V-10P	22	163.1	TLPH-400V-22P
Voltage	300V (UL) / 450V (VDE)	11	80.6	TLPH-400V-11P	23	170.6	TLPH-400V-23P
Approval Bodies		12	88.1	TLPH-400V-12P	24	178.1	TLPH-400V-24P
		13	95.6	TLPH-400V-13P			

2-24 Pole PCB mount - Male header Wave - through hole Vertical 7.5mm pitch

		N° of Poles	Pole Length (mm)	Product Code	N° of Poles	Pole Length (mm)	Product Code
Pitch (mm)	7.5	2	15	TLPHC-400V-02P	14	105	TLPHC-400V-14P
PCB Hole Ø	1.6-1.7	3	22.5	TLPHC-400V-03P	15	112.5	TLPHC-400V-15P
Orientation	Vertical	4	30	TLPHC-400V-04P	16	120	TLPHC-400V-16P
Mount Type	Wave - Through Hole	5	37.5	TLPHC-400V-05P	17	127.5	TLPHC-400V-17P
Screw	Slot Screw	6	45	TLPHC-400V-06P	18	135	TLPHC-400V-18P
Flange		7	52.5	TLPHC-400V-07P	19	142.5	TLPHC-400V-19P
Join	Solid body non stackable	8	60	TLPHC-400V-08P	20	150	TLPHC-400V-20P
Colour	Green or Black	9	67.5	TLPHC-400V-09P	21	157.5	TLPHC-400V-21P
Current	16A (UL) / 15A (VDE)	10	75	TLPHC-400V-10P	22	165	TLPHC-400V-22P
Voltage	300V (UL) / 450V (VDE)	11	82.5	TLPHC-400V-11P	23	172.5	TLPHC-400V-23P
Approval Bodies		12	90	TLPHC-400V-12P	24	180	TLPHC-400V-24P
		13	97.5	TLPHC-400V-13P			

*xx = number of poles

PCB TERMINAL BLOCKS - PLUGGABLE PIN HEADER (MALE) - SINGLE ROW PCB HEADER

TLP HDC-300V-xxP

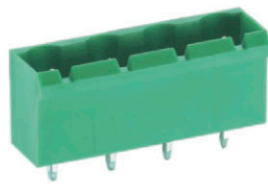
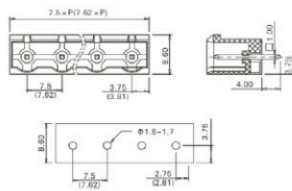

4-24 Pole PCB mount - Male header Wave - through hole Vertical 5.08mm pitch

		N° of Poles	Pole Length (mm)	Product Code	N° of Poles	Pole Length (mm)	Product Code
Pitch (mm)	7.5	4	12.88	TLP HDC-300V-04P			
PCB Hole Ø	1.6-1.7	6	17.96	TLP HDC-300V-06P			
Orientation	Vertical	8	23.04	TLP HDC-300V-08P			
Mount Type	Wave - Through Hole	10	28.12	TLP HDC-300V-10P			
Screw	Slot Screw	12	33.2	TLP HDC-300V-12P			
Flange		14	38.28	TLP HDC-300V-14P			
Join	Solid body non stackable	16	43.36	TLP HDC-300V-16P			
Colour	Green or Black	18	48.44	TLP HDC-300V-18P			
Current	12A	20	53.52	TLP HDC-300V-20P			
Voltage	300V	22	58.6	TLP HDC-300V-22P			
Approval Bodies		24	63.68	TLP HDC-300V-24P			

TLP HW-400V-xxP

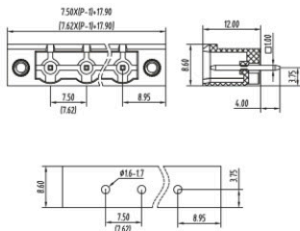

2-24 Pole PCB mount - Male header Wave - through hole Vertical 7.5mm pitch

		N° of Poles	Pole Length (mm)	Product Code	N° of Poles	Pole Length (mm)	Product Code
Pitch (mm)	7.5	2	25.4	TLP HW-400R-02P	14	115.4	TLP HW-400R-14P
PCB Hole Ø	1.6-1.7	3	32.9	TLP HW-400R-03P	15	122.9	TLP HW-400R-15P
Orientation	Vertical	4	40.4	TLP HW-400R-04P	16	130.4	TLP HW-400R-16P
Mount Type	Wave - Through Hole	5	47.9	TLP HW-400R-05P	17	137.9	TLP HW-400R-17P
Screw		6	55.4	TLP HW-400R-06P	18	145.4	TLP HW-400R-18P
Flange	With Flange	7	62.9	TLP HW-400R-07P	19	152.9	TLP HW-400R-19P
Join	Solid body non stackable	8	70.4	TLP HW-400R-08P	20	160.4	TLP HW-400R-20P
Colour	Green or Black	9	77.9	TLP HW-400R-09P	21	167.9	TLP HW-400R-21P
Current	16A (UL) / 15A (VDE)	10	85.4	TLP HW-400R-10P	22	175.4	TLP HW-400R-22P
Voltage	300V (UL) / 450V (VDE)	11	92.9	TLP HW-400R-11P	23	182.9	TLP HW-400R-23P
Approval Bodies		12	100.4	TLP HW-400R-12P	24	190.4	TLP HW-400R-24P
		13	107.9	TLP HW-400R-13P			

TLP H-500R-xxP

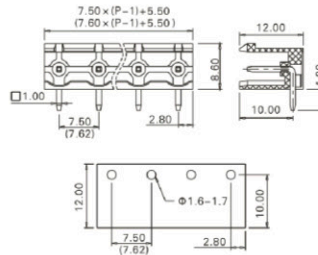

2-24 Pole PCB mount - Male header Wave - through hole Horizontal 7.62mm pitch

		N° of Poles	Pole Length (mm)	Product Code	N° of Poles	Pole Length (mm)	Product Code
Pitch (mm)	7.62	2	13.22	TLP H-500R-02P	14	104.66	TLP H-500R-14P
PCB Hole Ø	1.6-1.7	3	20.84	TLP H-500R-03P	15	112.28	TLP H-500R-15P
Orientation	Horizontal	4	28.46	TLP H-500R-04P	16	119.9	TLP H-500R-16P
Mount Type	Wave - Through Hole	5	36.08	TLP H-500R-05P	17	127.52	TLP H-500R-17P
Screw		6	43.7	TLP H-500R-06P	18	135.14	TLP H-500R-18P
Flange		7	51.32	TLP H-500R-07P	19	142.76	TLP H-500R-19P
Join	Solid body non stackable	8	58.94	TLP H-500R-08P	20	150.38	TLP H-500R-20P
Colour	Green or Black	9	66.56	TLP H-500R-09P	21	158	TLP H-500R-21P
Current	16A (UL) / 15A (VDE)	10	74.18	TLP H-500R-10P	22	165.62	TLP H-500R-22P
Voltage	300V (UL) / 450V (VDE)	11	81.8	TLP H-500R-11P	23	173.24	TLP H-500R-23P
Approval Bodies		12	89.42	TLP H-500R-12P	24	180.86	TLP H-500R-24P
		13	97.04	TLP H-500R-13P			

Features:

- Standard colour options include Green or Black

TLPHC-500R-xxP

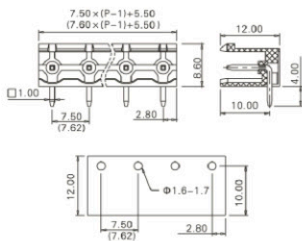

2-24 Pole PCB mount - Male header Wave - through hole Horizontal 7.62mm pitch

		N° of Poles	Pole Length (mm)	Product Code	N° of Poles	Pole Length (mm)	Product Code
Pitch (mm)	7.62	2	15.24	TLPHC-500R-02P	14	106.68	TLPHC-500R-14P
PCB Hole Ø	1.6-1.7	3	22.86	TLPHC-500R-03P	15	114.3	TLPHC-500R-15P
Orientation	Horizontal	4	30.48	TLPHC-500R-04P	16	121.92	TLPHC-500R-16P
Mount Type	Wave - Through Hole	5	38.1	TLPHC-500R-05P	17	129.54	TLPHC-500R-17P
Screw	Slot Screw	6	45.72	TLPHC-500R-06P	18	137.16	TLPHC-500R-18P
Flange		7	53.34	TLPHC-500R-07P	19	144.78	TLPHC-500R-19P
Join	Solid body non stackable	8	60.96	TLPHC-500R-08P	20	152.4	TLPHC-500R-20P
Colour	Green or Black	9	68.58	TLPHC-500R-09P	21	160.02	TLPHC-500R-21P
Current	16A (UL) / 15A (VDE)	10	76.2	TLPHC-500R-10P	22	167.64	TLPHC-500R-22P
Voltage	300V (UL) / 450V (VDE)	11	83.82	TLPHC-500R-11P	23	175.26	TLPHC-500R-23P
Approval Bodies		12	91.44	TLPHC-500R-12P	24	182.88	TLPHC-500R-24P
		13	99.06	TLPHC-500R-13P			

TLPHW-500R-xxP

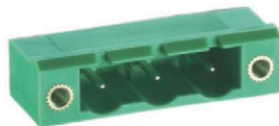
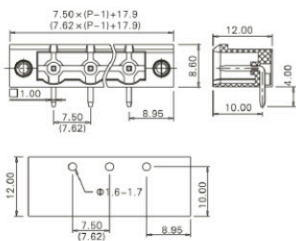

2-24 Pole PCB mount - Male header Wave - through hole Horizontal 7.62mm pitch

		N° of Poles	Pole Length (mm)	Product Code	N° of Poles	Pole Length (mm)	Product Code
Pitch (mm)	7.62	2	25.52	TLPHW-500R-02P	14	116.96	TLPHW-500R-14P
PCB Hole Ø	1.6-1.7	3	33.14	TLPHW-500R-03P	15	124.58	TLPHW-500R-15P
Orientation	Horizontal	4	40.76	TLPHW-500R-04P	16	132.2	TLPHW-500R-16P
Mount Type	Wave - Through Hole	5	48.38	TLPHW-500R-05P	17	139.82	TLPHW-500R-17P
Screw		6	56	TLPHW-500R-06P	18	147.44	TLPHW-500R-18P
Flange	With Flange	7	63.62	TLPHW-500R-07P	19	155.06	TLPHW-500R-19P
Join	Solid body non stackable	8	71.24	TLPHW-500R-08P	20	162.68	TLPHW-500R-20P
Colour	Green or Black	9	78.86	TLPHW-500R-09P	21	170.3	TLPHW-500R-21P
Current	16A (UL) / 15A (VDE)	10	86.48	TLPHW-500R-10P	22	177.92	TLPHW-500R-22P
Voltage	300V (UL) / 450V (VDE)	11	94.1	TLPHW-500R-11P	23	185.54	TLPHW-500R-23P
Approval Bodies		12	101.72	TLPHW-500R-12P	24	193.16	TLPHW-500R-24P
		13	109.34	TLPHW-500R-13P			

TLPH-500V-xxP

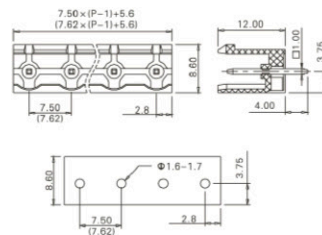

2-24 Pole PCB mount - Male header Wave - through hole Vertical 7.62mm pitch

		N° of Poles	Pole Length (mm)	Product Code	N° of Poles	Pole Length (mm)	Product Code
Pitch (mm)	7.62	2	13.22	TLPH-500V-02P	14	104.66	TLPH-500V-14P
PCB Hole Ø	1.6-1.7	3	20.84	TLPH-500V-03P	15	112.28	TLPH-500V-15P
Orientation	Vertical	4	28.46	TLPH-500V-04P	16	119.9	TLPH-500V-16P
Mount Type	Wave - Through Hole	5	36.08	TLPH-500V-05P	17	127.52	TLPH-500V-17P
Screw		6	43.7	TLPH-500V-06P	18	135.14	TLPH-500V-18P
Flange		7	51.32	TLPH-500V-07P	19	142.76	TLPH-500V-19P
Join	Solid body non stackable	8	58.94	TLPH-500V-08P	20	150.38	TLPH-500V-20P
Colour	Green or Black	9	66.56	TLPH-500V-09P	21	158	TLPH-500V-21P
Current	16A (UL) / 15A (VDE)	10	74.18	TLPH-500V-10P	22	165.62	TLPH-500V-22P
Voltage	300V (UL) / 450V (VDE)	11	81.8	TLPH-500V-11P	23	173.24	TLPH-500V-23P
Approval Bodies		12	89.42	TLPH-500V-12P	24	180.86	TLPH-500V-24P
		13	97.04	TLPH-500V-13P			

*xx = number of poles

PCB TERMINAL BLOCKS - PLUGGABLE PIN HEADER (MALE) - SINGLE ROW PCB HEADER

TLPHC-500V-xxP

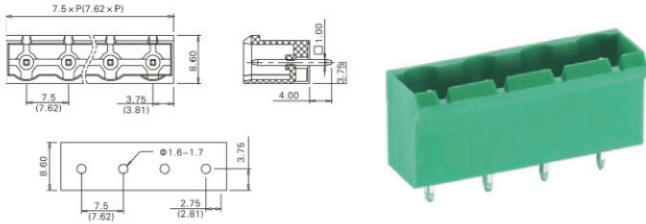

2-24 Pole PCB mount - Male header Wave - through hole Vertical 7.62mm pitch

		N° of Poles	Pole Length (mm)	Product Code	N° of Poles	Pole Length (mm)	Product Code
Pitch (mm)	7.62	2	15.24	TLPHC-500R-02P	14	106.68	TLPHC-500R-14P
PCB Hole Ø	1.6-1.7	3	22.86	TLPHC-500R-03P	15	114.3	TLPHC-500R-15P
Orientation	Vertical	4	30.48	TLPHC-500R-04P	16	121.92	TLPHC-500R-16P
Mount Type	Wave - Through Hole	5	38.1	TLPHC-500R-05P	17	129.54	TLPHC-500R-17P
Screw	Slot Screw	6	45.72	TLPHC-500R-06P	18	137.16	TLPHC-500R-18P
Flange		7	53.34	TLPHC-500R-07P	19	144.78	TLPHC-500R-19P
Join	Solid body non stackable	8	60.96	TLPHC-500R-08P	20	152.4	TLPHC-500R-20P
Colour	Green or Black	9	68.58	TLPHC-500R-09P	21	160.02	TLPHC-500R-21P
Current	16A (UL) / 15A (VDE)	10	76.2	TLPHC-500R-10P	22	167.64	TLPHC-500R-22P
Voltage	300V (UL) / 450V (VDE)	11	83.82	TLPHC-500R-11P	23	175.26	TLPHC-500R-23P
Approval Bodies		12	91.44	TLPHC-500R-12P	24	182.88	TLPHC-500R-24P
		13	99.06	TLPHC-500R-13P			

TLPH-200R-xxP5

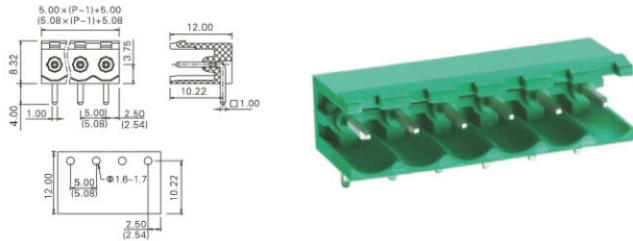

2-8 Pole PCB mount - Male header Wave - through hole Horizontal 10mm pitch

		N° of Poles	Pole Length (mm)	Product Code	N° of Poles	Pole Length (mm)	Product Code
Pitch (mm)	10	2	15	TLPH-200R-02P5			
PCB Hole Ø	1.6-1.7	3	25	TLPH-200R-03P5			
Orientation	Horizontal	4	35	TLPH-200R-04P5			
Mount Type	Wave - Through Hole	5	45	TLPH-200R-05P5			
Screw		6	55	TLPH-200R-06P5			
Flange		7	65	TLPH-200R-07P5			
Join	Solid body non stackable	8	75	TLPH-200R-08P5			
Colour	Green or Black						
Current	16A (UL) / 15A (VDE)						
Voltage	300V (UL) / 250V (VDE)						
Approval Bodies							

TLPHC-200R-xxP5

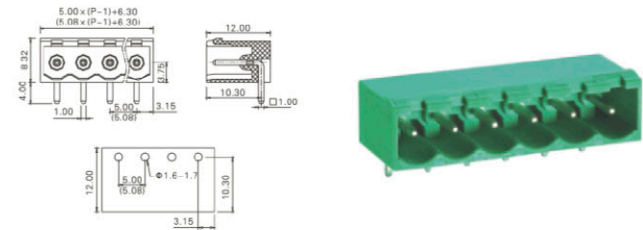

2-8 Pole PCB mount - Male header Wave - through hole Horizontal 10mm pitch

		N° of Poles	Pole Length (mm)	Product Code	N° of Poles	Pole Length (mm)	Product Code
Pitch (mm)	10	2	16.3	TLPHC-200R-02P5			
PCB Hole Ø	1.6-1.7	3	26.3	TLPHC-200R-03P5			
Orientation	Horizontal	4	36.3	TLPHC-200R-04P5			
Mount Type	Wave - Through Hole	5	46.3	TLPHC-200R-05P5			
Screw	Slot Screw	6	56.3	TLPHC-200R-06P5			
Flange		7	66.3	TLPHC-200R-07P5			
Join	Solid body non stackable	8	76.3	TLPHC-200R-08P5			
Colour	Green or Black						
Current	16A (UL) / 15A (VDE)						
Voltage	300V (UL) / 250V (VDE)						
Approval Bodies							

Features:

- Standard colour options include Green or Black

TLPHW-200R-xxP5

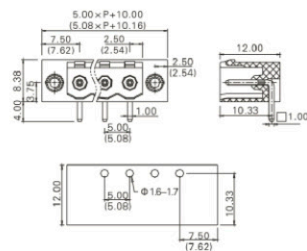

2-8 Pole PCB mount - Male header Wave - through hole Horizontal 10mm pitch

	N° of Poles	Pole Length (mm)	Product Code	N° of Poles	Pole Length (mm)	Product Code
Pitch (mm)	10	2	25	TLPHW-200R-02P5		
PCB Hole Ø	1.6-1.7	3	35	TLPHW-200R-03P5		
Orientation	Horizontal	4	45	TLPHW-200R-04P5		
Mount Type	Wave - Through Hole	5	55	TLPHW-200R-05P5		
Screw		6	65	TLPHW-200R-06P5		
Flange	With Flange	7	75	TLPHW-200R-07P5		
Join	Solid body non stackable	8	85	TLPHW-200R-08P5		
Colour	Green or Black					
Current	Current: 16A / Voltage: 300V					
Voltage	300V (UL) / 550V (VDE)					
Approval Bodies						

TLPH-200V-xxP5

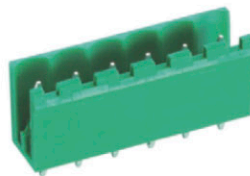
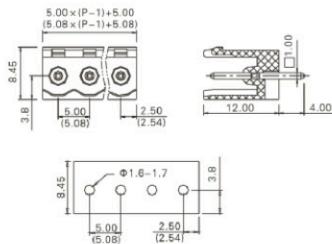

2-8 Pole PCB mount - Male header Wave - through hole Vertical 10mm pitch

	N° of Poles	Pole Length (mm)	Product Code	N° of Poles	Pole Length (mm)	Product Code
Pitch (mm)	10	2	15	25	TLPH-200V-02P5	
PCB Hole Ø	1.6-1.7	3	25	TLPH-200V-03P5		
Orientation	Vertical	4	35	TLPH-200V-04P5		
Mount Type	Wave - Through Hole	5	45	TLPH-200V-05P5		
Screw		6	60	TLPH-200V-06P5		
Flange		7	70	TLPH-200V-07P5		
Join	Solid body non stackable	8	80	TLPH-200V-08P5		
Colour	Green or Black					
Current	16A (UL) / 15A (VDE)					
Voltage	300V (UL) / 250V (VDE)					
Approval Bodies						

TLPHC-200V-xxP5

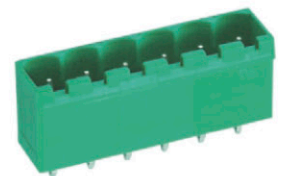
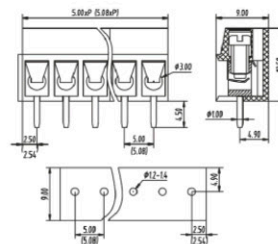

2-8 Pole PCB mount - Male header Wave - through hole Vertical 10mm pitch

	N° of Poles	Pole Length (mm)	Product Code	N° of Poles	Pole Length (mm)	Product Code
Pitch (mm)	10	2	17.2	25	TLPHC-200V-02P5	
PCB Hole Ø	1.6-1.7	3	27.2	TLPHC-200V-03P5		
Orientation	Vertical	4	37.2	TLPHC-200V-04P5		
Mount Type	Wave - Through Hole	5	47.2	TLPHC-200V-05P5		
Screw	Slot Screw	6	57.2	TLPHC-200V-06P5		
Flange		7	67.2	TLPHC-200V-07P5		
Join	Solid body non stackable	8	77.2	TLPHC-200V-08P5		
Colour	Green or Black					
Current	16A (UL) / 15A (VDE)					
Voltage	300V (UL) / 250V (VDE)					
Approval Bodies						

*xx = number of poles

PCB TERMINAL BLOCKS - PLUGGABLE PIN HEADER (MALE) - SINGLE ROW PCB HEADER

TLPHW-200V-xxP5

2-8 Pole PCB mount - Male header Wave - through hole Vertical 10mm pitch

		N° of Poles	Pole Length (mm)	Product Code	N° of Poles	Pole Length (mm)	Product Code
Pitch (mm)	10	2	25	TLPHW-200V-02P5			
PCB Hole Ø	1.6-1.7	3	35	TLPHW-200V-03P5			
Orientation	Vertical	4	45	TLPHW-200V-04P5			
Mount Type	Wave - Through Hole	5	55	TLPHW-200V-05P5			
Screw		6	65	TLPHW-200V-06P5			
Flange	With Flange	7	75	TLPHW-200V-07P5			
Join	Solid body non stackable	8	85	TLPHW-200V-08P5			
Colour	Green or Black						
Current	16A (UL) / 15A (VDE)						
Voltage	300V (UL) / 250V (VDE)						
Approval Bodies							

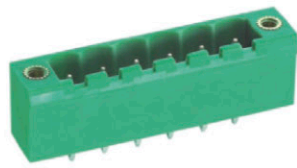
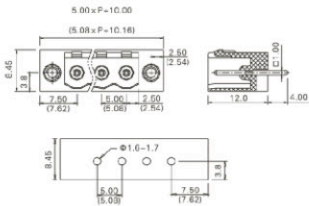

TLPH-300R-xxP5

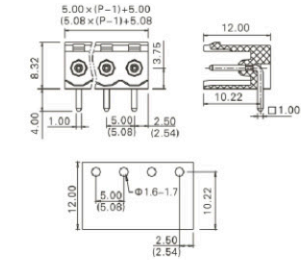

2-8 Pole PCB mount - Male header Wave - through hole Horizontal 10.16mm pitch

		N° of Poles	Pole Length (mm)	Product Code	N° of Poles	Pole Length (mm)	Product Code
Pitch (mm)	10.16	2	15.24	TLPH-300R-02P5			
PCB Hole Ø	1.6-1.7	3	25.4	TLPH-300R-03P5			
Orientation	Horizontal	4	35.56	TLPH-300R-04P5			
Mount Type	Wave - Through Hole	5	45.72	TLPH-300R-05P5			
Screw		6	55.88	TLPH-300R-06P5			
Flange		7	66.04	TLPH-300R-07P5			
Join	Solid body non stackable	8	76.2	TLPH-300R-08P5			
Colour	Green or Black						
Current	16A (UL) / 15A (VDE)						
Voltage	300V (UL) / 250V (VDE)						
Approval Bodies							

TLPHC-300R-xxP5

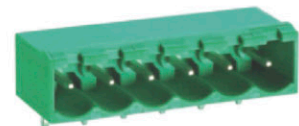
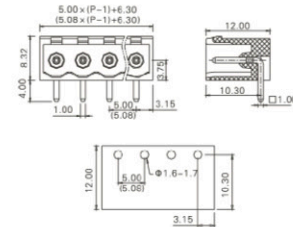

2-8 Pole PCB mount - Male header Wave - through hole Horizontal 10.16mm pitch

		N° of Poles	Pole Length (mm)	Product Code	N° of Poles	Pole Length (mm)	Product Code
Pitch (mm)	10.16	2	16.46	TLPHC-300R-02P5			
PCB Hole Ø	1.6-1.7	3	26.62	TLPHC-300R-03P5			
Orientation	Horizontal	4	36.78	TLPHC-300R-04P5			
Mount Type	Wave - Through Hole	5	46.94	TLPHC-300R-05P5			
Screw	Slot Screw	6	57.1	TLPHC-300R-06P5			
Flange		7	67.26	TLPHC-300R-07P5			
Join	Solid body non stackable	8	77.42	TLPHC-300R-08P5			
Colour	Green or Black						
Current	16A (UL) / 15A (VDE)						
Voltage	300V (UL) / 250V (VDE)						
Approval Bodies							

*xx = number of poles

Features:

- Standard colour options include Green or Black

TLPHW-300R-xxP5

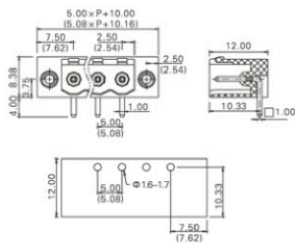

2-8 Pole PCB mount - Male header Wave - through hole Horizontal 10.16mm pitch

		N° of Poles	Pole Length (mm)	Product Code	N° of Poles	Pole Length (mm)	Product Code
Pitch (mm)	10.16	2	25.4	TLPHW-300R-02P5			
PCB Hole Ø	1.6-1.7	3	35.56	TLPHW-300R-03P5			
Orientation	Horizontal	4	45.72	TLPHW-300R-04P5			
Mount Type	Wave - Through Hole	5	55.88	TLPHW-300R-05P5			
Screw		6	66.04	TLPHW-300R-06P5			
Flange	With Flange	7	76.2	TLPHW-300R-07P5			
Join	Solid body non stackable	8	86.36	TLPHW-300R-08P5			
Colour	Green or Black						
Current	16A (UL) / 15A (VDE)						
Voltage	300V (UL) / 250V (VDE)						
Approval Bodies							

TLPH-300V-xxP5

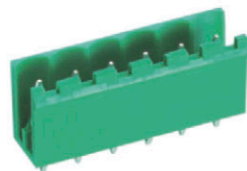
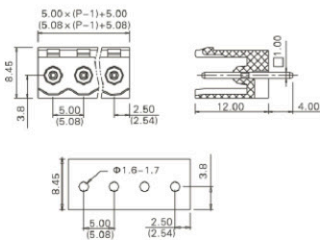

2-8 Pole PCB mount - Male header Wave - through hole Vertical 10.16mm pitch

		N° of Poles	Pole Length (mm)	Product Code	N° of Poles	Pole Length (mm)	Product Code
Pitch (mm)	10.16	2	15.24	TLPH-300R-02P5			
PCB Hole Ø	1.6-1.7	3	25.4	TLPH-300R-03P5			
Orientation	Vertical	4	35.56	TLPH-300R-04P5			
Mount Type	Wave - Through Hole	5	45.72	TLPH-300R-05P5			
Screw		6	55.88	TLPH-300R-06P5			
Flange		7	66.04	TLPH-300R-07P5			
Join	Solid body non stackable	8	76.2	TLPH-300R-08P5			
Colour	Green or Black						
Current	16A (UL) / 15A (VDE)						
Voltage	300V (UL) / 250V (VDE)						
Approval Bodies							

TLPHC-300V-xxP5

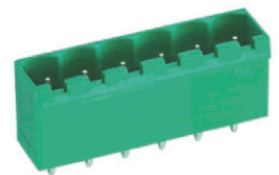
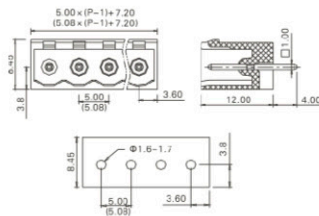

2-8 Pole PCB mount - Male header Wave - through hole Vertical 10.16mm pitch

		N° of Poles	Pole Length (mm)	Product Code	N° of Poles	Pole Length (mm)	Product Code
Pitch (mm)	10.16	2	17.36	TLPHC-300V-02P5			
PCB Hole Ø	1.6-1.7	3	27.52	TLPHC-300V-03P5			
Orientation	Vertical	4	37.68	TLPHC-300V-04P5			
Mount Type	Wave - Through Hole	5	47.84	TLPHC-300V-05P5			
Screw	Slot Screw	6	58	TLPHC-300V-06P5			
Flange		7	68.16	TLPHC-300V-07P5			
Join	Solid body non stackable	8	78.32	TLPHC-300V-08P5			
Colour	Green or Black						
Current	16A (UL) / 15A (VDE)						
Voltage	300V (UL) / 250V (VDE)						
Approval Bodies							

*xx = number of poles

PCB TERMINAL BLOCKS - PLUGGABLE PIN HEADER (MALE) - SINGLE ROW PCB HEADER

TLPHW-300V-xxP5

2-8 Pole PCB mount - Male header Wave -
through hole Vertical 10.16mm pitch

		N° of Poles	Pole Length (mm)	Product Code	N° of Poles	Pole Length (mm)	Product Code
Pitch (mm)	10.16	2	25.4	TLPHW-300V-02P5			
PCB Hole Ø	1.4	3	35.56	TLPHW-300V-03P5			
Orientation	Vertical	4	45.72	TLPHW-300V-04P5			
Mount Type	Wave - Through Hole	5	55.88	TLPHW-300V-05P5			
Screw		6	66.04	TLPHW-300V-06P5			
Flange	With Flange	7	76.2	TLPHW-300V-07P5			
Join	Solid body non stackable	8	86.36	TLPHW-300V-08P5			
Colour	Green or Black						
Current	16A (UL) / 15A (VDE)						
Voltage	300V (UL) / 150V (VDE)						
Approval Bodies							

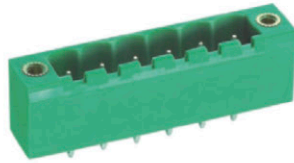
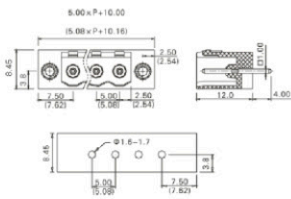

TL SERIES PLUGGABLE
CONNECTORS:
PITCH 3.5, 3.81, 5.0, 5.08
POLES 2-24

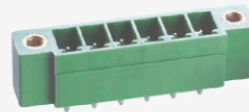

PCB TERMINAL BLOCKS - PLUGGABLE PIN HEADER (MALE) - DOUBLE DECKER PCB HEADER

TLP HDC-105V-xxP

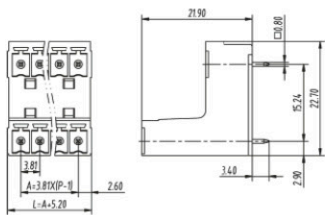

4-48 Pole Pluggable type Vertical 3.81mm pitch

	N° of Poles	Pole Length (mm)	Product Code	N° of Poles	Pole Length (mm)	Product Code	
Pitch (mm)	3.81	4	8.41	TLP HDC-105V-04P	28	54.13	TLP HDC-105V-28P
Wire Size (mm ²)		6	12.22	TLP HDC-105V-06P	30	57.94	TLP HDC-105V-30P
PCB Hole Ø	1.4	8	16.03	TLP HDC-105V-08P	32	61.75	TLP HDC-105V-32P
Orientation	Vertical	10	19.84	TLP HDC-105V-10P	34	65.56	TLP HDC-105V-34P
Mount Type	Vertical	12	23.65	TLP HDC-105V-12P	36	69.37	TLP HDC-105V-36P
Screw	Slot Screw	14	27.46	TLP HDC-105V-14P	38	73.18	TLP HDC-105V-38P
Join	Solid body non stackable	16	31.27	TLP HDC-105V-16P	40	76.99	TLP HDC-105V-40P
Colour	Green or Black	18	35.08	TLP HDC-105V-18P	42	80.8	TLP HDC-105V-42P
Current	8A	20	38.89	TLP HDC-105V-20P	44	84.61	TLP HDC-105V-44P
Voltage	300V	22	42.7	TLP HDC-105V-22P	46	88.42	TLP HDC-105V-46P
Approval Bodies		24	46.51	TLP HDC-105V-24P	48	92.23	TLP HDC-105V-48P
		26	50.32	TLP HDC-105V-26P			

TLP HD-303R-xxP

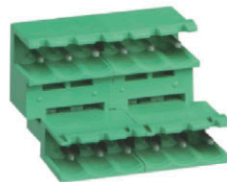
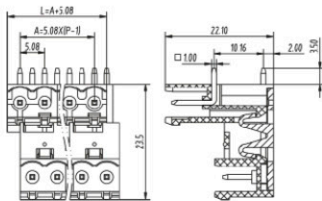

TLP HD-303V-xxP

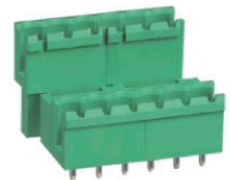
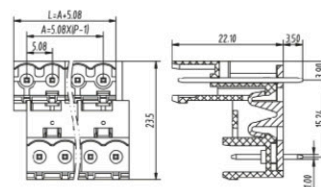

4-48 Pole Pluggable type Vertical Horizontal 5.08mm pitch

	N° of Poles	Pole Length (mm)	Product Code	N° of Poles	Pole Length (mm)	Product Code	
Pitch (mm)	5.08	4	12.7	TLP HD-303R-04P	28	73.66	TLP HD-303R-28P
Wire Size (mm ²)		6	17.78	TLP HD-303R-06P	30	78.74	TLP HD-303R-30P
PCB Hole Ø	1.6-1.7	8	22.86	TLP HD-303R-08P	32	83.82	TLP HD-303R-32P
Orientation	Vertical	10	27.94	TLP HD-303R-10P	34	88.9	TLP HD-303R-34P
Mount Type	Vertical	12	33.02	TLP HD-303R-12P	36	93.98	TLP HD-303R-36P
Screw		14	38.1	TLP HD-303R-14P	38	99.06	TLP HD-303R-38P
Join	Solid body non stackable	16	43.18	TLP HD-303R-16P	40	104.14	TLP HD-303R-40P
Colour	Green or Black	18	48.26	TLP HD-303R-18P	42	109.22	TLP HD-303R-42P
Current	16A	20	53.34	TLP HD-303R-20P	44	114.3	TLP HD-303R-44P
Voltage	300V	22	58.42	TLP HD-303R-22P	46	119.38	TLP HD-303R-46P
Approval Bodies		24	63.5	TLP HD-303R-24P	48	124.46	TLP HD-303R-48P
		26	68.58	TLP HD-303R-26P			

4-48 Pole Pluggable type Vertical 5.08mm pitch

	N° of Poles	Pole Length (mm)	Product Code	N° of Poles	Pole Length (mm)	Product Code	
Pitch (mm)	5.08	4	12.7	TLP HD-303V-04P	28	73.66	TLP HD-303V-28P
Wire Size (mm ²)		6	17.78	TLP HD-303V-06P	30	78.74	TLP HD-303V-30P
PCB Hole Ø	1.6-1.7	8	22.86	TLP HD-303V-08P	32	83.82	TLP HD-303V-32P
Orientation	Vertical	10	27.94	TLP HD-303V-10P	34	88.9	TLP HD-303V-34P
Mount Type	Vertical	12	33.02	TLP HD-303V-12P	36	93.98	TLP HD-303V-36P
Screw		14	38.1	TLP HD-303V-14P	38	99.06	TLP HD-303V-38P
Join	Solid body non stackable	16	43.18	TLP HD-303V-16P	40	104.14	TLP HD-303V-40P
Colour	Green or Black	18	48.26	TLP HD-303V-18P	42	109.22	TLP HD-303V-42P
Current	16A	20	53.34	TLP HD-303V-20P	44	114.3	TLP HD-303V-44P
Voltage	300V	22	58.42	TLP HD-303V-22P	46	119.38	TLP HD-303V-46P
Approval Bodies		24	63.5	TLP HD-303V-24P	48	124.46	TLP HD-303V-48P
		26	68.58	TLP HD-303V-26P			

*xx = number of poles

PCB TERMINAL BLOCKS - PLUGGABLE PIN HEADER (MALE) - DOUBLE DECKER PCB HEADER

TLP HDC-303R-xxP

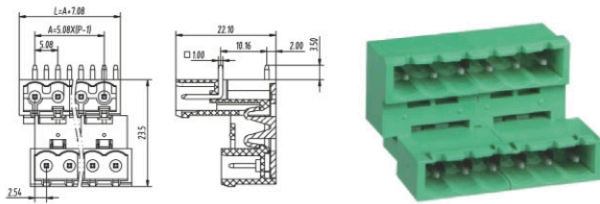

4-48 Pole Pluggable type Vertical Horizontal
5.08mm pitch

		N° of Poles	Pole Length (mm)	Product Code	N° of Poles	Pole Length (mm)	Product Code
Pitch (mm)	5.08	4	14.7	TLP HDC-303R-04P	28	75.66	TLP HDC-303R-28P
Wire Size (mm ²)		6	19.78	TLP HDC-303R-06P	30	80.74	TLP HDC-303R-30P
PCB Hole Ø	1.6-1.7	8	24.86	TLP HDC-303R-08P	32	85.82	TLP HDC-303R-32P
Orientation	Vertical	10	29.94	TLP HDC-303R-10P	34	90.9	TLP HDC-303R-34P
Mount Type	Vertical	12	35.02	TLP HDC-303R-12P	36	95.98	TLP HDC-303R-36P
Screw		14	40.1	TLP HDC-303R-14P	38	101.06	TLP HDC-303R-38P
Join	Solid body non stackable	16	45.18	TLP HDC-303R-16P	40	106.14	TLP HDC-303R-40P
Colour	Green	18	50.26	TLP HDC-303R-18P	42	111.22	TLP HDC-303R-42P
Current	16A	20	55.34	TLP HDC-303R-20P	44	116.3	TLP HDC-303R-44P
Voltage	300V	22	60.42	TLP HDC-303R-22P	46	121.38	TLP HDC-303R-46P
Approval Bodies		24	65.5	TLP HDC-303R-24P	48	126.46	TLP HDC-303R-48P
		26	70.58	TLP HDC-303R-26P			

TLP HDC-303V-xxP

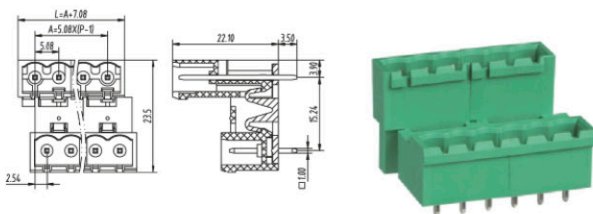

4-48 Pole Pluggable type Vertical 5.08mm
pitch

		N° of Poles	Pole Length (mm)	Product Code	N° of Poles	Pole Length (mm)	Product Code
Pitch (mm)	5.08	4	14.7	TLP HDC-303V-04P	28	75.66	TLP HDC-303V-28P
Wire Size (mm ²)		6	19.78	TLP HDC-303V-06P	30	80.74	TLP HDC-303V-30P
PCB Hole Ø	1.6-1.7	8	24.86	TLP HDC-303V-08P	32	85.82	TLP HDC-303V-32P
Orientation	Vertical	10	29.94	TLP HDC-303V-10P	34	90.9	TLP HDC-303V-34P
Mount Type	Vertical	12	35.02	TLP HDC-303V-12P	36	95.98	TLP HDC-303V-36P
Screw	Slot Screw	14	40.1	TLP HDC-303V-14P	38	101.06	TLP HDC-303V-38P
Join	Solid body non stackable	16	45.18	TLP HDC-303V-16P	40	106.14	TLP HDC-303V-40P
Colour	Green	18	50.26	TLP HDC-303V-18P	42	111.22	TLP HDC-303V-42P
Current	16A	20	55.34	TLP HDC-303V-20P	44	116.3	TLP HDC-303V-44P
Voltage	300V	22	60.42	TLP HDC-303V-22P	46	121.38	TLP HDC-303V-46P
Approval Bodies		24	65.5	TLP HDC-303V-24P	48	126.46	TLP HDC-303V-48P
		26	70.58	TLP HDC-303V-26P			

TLP HDW-303R-xxP

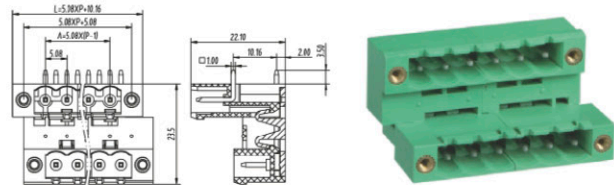

4-48 Pole Pluggable type Vertical Horizontal
5.08mm pitch

		N° of Poles	Pole Length (mm)	Product Code	N° of Poles	Pole Length (mm)	Product Code
Pitch (mm)	5.08	4	22.86	TLP HDW-303R-04P	28	83.82	TLP HDW-303R-28P
Wire Size (mm ²)		6	27.94	TLP HDW-303R-06P	30	88.9	TLP HDW-303R-30P
PCB Hole Ø	1.6-1.7	8	33.02	TLP HDW-303R-08P	32	93.98	TLP HDW-303R-32P
Orientation	Vertical	10	38.1	TLP HDW-303R-10P	34	99.06	TLP HDW-303R-34P
Mount Type	Vertical	12	43.18	TLP HDW-303R-12P	36	104.14	TLP HDW-303R-36P
Screw		14	48.26	TLP HDW-303R-14P	38	109.22	TLP HDW-303R-38P
Join	Solid body non stackable	16	53.34	TLP HDW-303R-16P	40	114.3	TLP HDW-303R-40P
Colour	Green	18	58.42	TLP HDW-303R-18P	42	119.38	TLP HDW-303R-42P
Current	16A	20	63.5	TLP HDW-303R-20P	44	124.46	TLP HDW-303R-44P
Voltage	300V	22	68.58	TLP HDW-303R-22P	46	129.54	TLP HDW-303R-46P
Approval Bodies		24	73.66	TLP HDW-303R-24P	48	134.62	TLP HDW-303R-48P
		26	78.74	TLP HDW-303R-26P			

TLPDHW-303V-xxP

4-48 Pole Pluggable type Vertical 5.08mm pitch

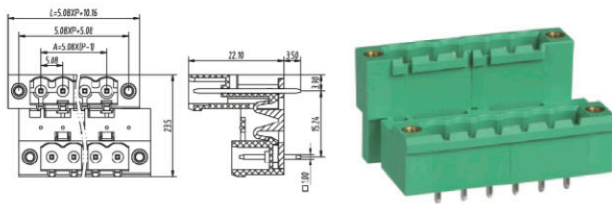

		N° of Poles	Pole Length (mm)	Product Code	N° of Poles	Pole Length (mm)	Product Code
Pitch (mm)	5.08	4	22.86	TLPDHW-303V-04P	28	83.82	TLPDHW-303V-28P
Wire Size (mm ²)		6	27.94	TLPDHW-303V-06P	30	88.9	TLPDHW-303V-30P
PCB Hole Ø	1.6-1.7	8	33.02	TLPDHW-303V-08P	32	93.98	TLPDHW-303V-32P
Orientation	Vertical	10	38.1	TLPDHW-303V-10P	34	99.06	TLPDHW-303V-34P
Mount Type	Vertical	12	43.18	TLPDHW-303V-12P	36	104.14	TLPDHW-303V-36P
Screw	Slot Screw	14	48.26	TLPDHW-303V-14P	38	109.22	TLPDHW-303V-38P
Join	Solid body non stackable	16	53.34	TLPDHW-303V-16P	40	114.3	TLPDHW-303V-40P
Colour	Green	18	58.42	TLPDHW-303V-18P	42	119.38	TLPDHW-303V-42P
Current	16A	20	63.5	TLPDHW-303V-20P	44	124.46	TLPDHW-303V-44P
Voltage	300V	22	68.58	TLPDHW-303V-22P	46	129.54	TLPDHW-303V-46P
Approval Bodies		24	73.66	TLPDHW-303V-24P	48	134.62	TLPDHW-303V-48P
		26	78.74	TLPDHW-303V-26P			

HALO
TRAINING THE NEXT
GENERATION



- SPECIAL OFFERS
- FREE WORKSHOPS
- FREE PRODUCT SAMPLES

HALO supports tomorrow's professional installers by providing the tools they need for the future.

Book yourself on the next practical workshop by scanning, calling or visiting the website below.

TO FIND OUT MORE CALL **01933 234 400**
OR VISIT: www.hylec-halo.com



SCAN TO FIND
OUT MORE

PCB TERMINAL BLOCKS - PLUGGABLE CABLE MOUNTING - PLUGGABLE (FEMALE)

TLPS-006V-xxP

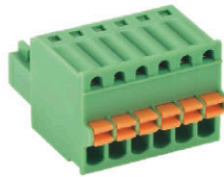
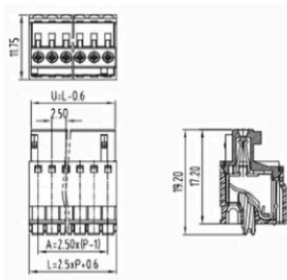

2-24 Pole Pluggable type Horizontal 2.5mm pitch

		N° of Poles	Pole Length (mm)	Product Code	N° of Poles	Pole Length (mm)	Product Code
Pitch (mm)	2.5	2	3.1	TLPS-006V-02P	14	33.1	TLPS-006V-14P
Wire Size (mm ²)		3	5.6	TLPS-006V-03P	15	35.6	TLPS-006V-15P
PCB Hole Ø		4	8.1	TLPS-006V-04P	16	38.1	TLPS-006V-16P
Orientation	Horizontal	5	10.6	TLPS-006V-05P	17	40.6	TLPS-006V-17P
Mount Type	Horizontal	6	13.1	TLPS-006V-06P	18	43.1	TLPS-006V-18P
Join	Solid body non stackable	7	15.6	TLPS-006V-07P	19	45.6	TLPS-006V-19P
Current	4A	8	18.1	TLPS-006V-08P	20	48.1	TLPS-006V-20
Voltage	150V	9	20.6	TLPS-006V-09P	21	50.6	TLPS-006V-21P
Approval Bodies		10	23.1	TLPS-006V-10P	22	53.1	TLPS-006V-22P
		11	25.6	TLPS-006V-11P	23	55.6	TLPS-006V-23P
		12	28.1	TLPS-006V-12P	24	58.1	TLPS-006V-24P
		13	30.6	TLPS-006V-13P			

TL006T-xxPKS

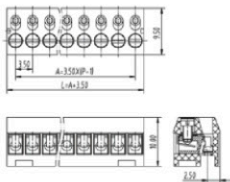

2-24 Pole Wire Protector Vertical 3.5mm pitch

		N° of Poles	Pole Length (mm)	Product Code	N° of Poles	Pole Length (mm)	Product Code
Pitch (mm)	3.5	2	7	TL006T-02PKS	14	49	TL006T-02PKS
Wire Size (mm ²)	Min:28 / Max: 16	3	10.5	TL006T-02PKS	15	52.5	TL006T-02PKS
PCB Hole Ø	Max: 1.5	4	14	TL006T-02PKS	16	56	TL006T-02PKS
Orientation	Vertical	5	17.5	TL006T-02PKS	17	59.5	TL006T-02PKS
Mount Type	Wire Protector	6	21	TL006T-02PKS	18	63	TL006T-02PKS
Join	Solid body non stackable	7	24.5	TL006T-02PKS	19	66.5	TL006T-02PKS
Length (mm)		8	28	TL006T-02PKS	20	70	TL006T-02PKS
Current	10A	9	31.5	TL006T-02PKS	21	73.5	TL006T-02PKS
Voltage	300V	10	35	TL006T-02PKS	22	77	TL006T-02PKS
Approval Bodies		11	38.5	TL006T-02PKS	23	80.5	TL006T-02PKS
		12	42	TL006T-02PKS	24	84	TL006T-02PKS
		13	45.5	TL006T-02PKS			

TLPS-007V-xxP

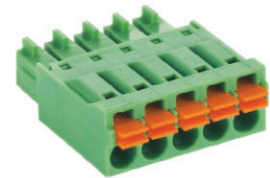
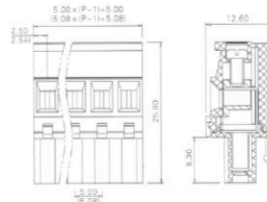

2-24 Pole Pluggable type Horizontal 3.5mm pitch

		N° of Poles	Pole Length (mm)	Product Code	N° of Poles	Pole Length (mm)	Product Code
Pitch (mm)	3.5	2	7.7	TLPS-007V-02P	14	49.7	TLPS-007V-14P
Wire Size (mm ²)		3	11.2	TLPS-007V-03P	15	53.2	TLPS-007V-15P
PCB Hole Ø		4	14.7	TLPS-007V-04P	16	56.7	TLPS-007V-16P
Orientation	Horizontal	5	18.2	TLPS-007V-05P	17	60.2	TLPS-007V-17P
Mount Type	Horizontal	6	21.7	TLPS-007V-06P	18	63.7	TLPS-007V-18P
Join	Solid body non stackable	7	25.2	TLPS-007V-07P	19	67.2	TLPS-007V-19P
Current	8A	8	28.7	TLPS-007V-08P	20	70.7	TLPS-007V-20P
Voltage	150V	9	32.2	TLPS-007V-09P	21	74.2	TLPS-007V-21P
Approval Bodies		10	35.7	TLPS-007V-10P	22	77.7	TLPS-007V-22P
		11	39.2	TLPS-007V-11P	23	81.2	TLPS-007V-23P
		12	42.7	TLPS-007V-12P	24	84.7	TLPS-007V-24P
		13	46.2	TLPS-007V-13P			

TLPS-002V-xxP

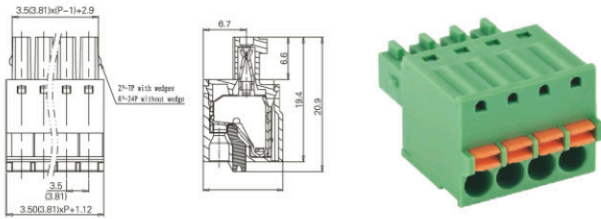

2-24 Pole Pluggable type Horizontal
3.5mm pitch

		N° of Poles	Pole Length (mm)	Product Code	N° of Poles	Pole Length (mm)	Product Code
Pitch (mm)	3.5	2	6.4	TLPS-002V-02P	14	48.4	TLPS-002V-14P
Wire Size AWG	Min: 24 / Max: 12	3	9.9	TLPS-002V-03P	15	51.9	TLPS-002V-15P
Wire Size (mm²)	Min: 0.2 / Max: 4	4	13.4	TLPS-002V-04P	16	55.4	TLPS-002V-16P
PCB Hole Ø		5	16.9	TLPS-002V-05P	17	58.9	TLPS-002V-17P
Orientation	Horizontal	6	20.4	TLPS-002V-06P	18	62.4	TLPS-002V-18P
Mount Type	Horizontal	7	23.9	TLPS-002V-07P	19	65.9	TLPS-002V-19P
Join		8	27.4	TLPS-002V-08P	20	69.4	TLPS-002V-20P
Current	12A	9	30.9	TLPS-002V-09P	21	72.9	TLPS-002V-21P
Voltage	300V	10	34.4	TLPS-002V-10P	22	76.4	TLPS-002V-22P
Approval Bodies	UL	11	37.9	TLPS-002V-11P	23	79.9	TLPS-002V-23P
		12	41.4	TLPS-002V-12P	24	83.4	TLPS-002V-24P
		13	44.9	TLPS-002V-13P			

TLPS-003-xxP

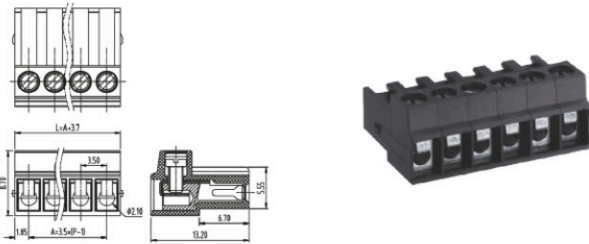

2-24 Pole Pluggable type Horizontal
3.5mm pitch

		N° of Poles	Pole Length (mm)	Product Code	N° of Poles	Pole Length (mm)	Product Code
Pitch (mm)	3.5	2	7.2	TLPS-003-02P	14	49.2	TLPS-003-14P
Wire Size AWG	Min: 26 / Max: 16	3	10.7	TLPS-003-03P	15	52.7	TLPS-003-15P
Wire Size (mm²)	Min: 0.2 / Max: 1.5	4	14.2	TLPS-003-04P	16	56.2	TLPS-003-16P
PCB Hole Ø		5	17.7	TLPS-003-05P	17	59.7	TLPS-003-17P
Orientation	Horizontal	6	21.2	TLPS-003-06P	18	63.2	TLPS-003-18P
Mount Type	Horizontal	7	24.7	TLPS-003-07P	19	66.7	TLPS-003-19P
Join		8	28.2	TLPS-003-08P	20	70.2	TLPS-002V-20P
Current	10A	9	31.7	TLPS-003-09P	21	73.7	TLPS-003-21P
Voltage	300V	10	35.2	TLPS-003-10P	22	77.2	TLPS-003-22P
Approval Bodies	UL	11	38.7	TLPS-003-11P	23	80.7	TLPS-003-23P
		12	42.2	TLPS-003-12P	24	84.2	TLPS-003-24P
		13	45.7	TLPS-003-13P			

TLPSD-007V-xxP

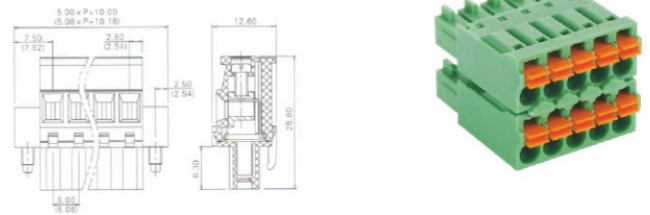

4-48 Pole Pluggable type Horizontal
3.5mm pitch

		N° of Poles	Pole Length (mm)	Product Code	N° of Poles	Pole Length (mm)	Product Code
Pitch (mm)	3.5	4	14.7	TLPSD-007V-04P	30	60.2	TLPSD-007V-30P
Wire Size AWG		6	18.2	TLPSD-007V-06P	32	63.7	TLPSD-007V-32P
Wire Size (mm²)		8	21.7	TLPSD-007V-08P	34	67.2	TLPSD-007V-34P
PCB Hole Ø		10	25.2	TLPSD-007V-10P	36	70.7	TLPSD-007V-36P
Orientation	Horizontal	12	28.7	TLPSD-007V-12P	38	74.2	TLPSD-007V-38P
Mount Type	Horizontal	14	32.2	TLPSD-007V-14P	40	77.7	TLPSD-007V-40P
Join	Solid body non stackable	16	35.7	TLPSD-007V-16P	42	81.2	TLPSD-007V-42P
Current	8A	18	39.2	TLPSD-007V-18P	44	84.7	TLPSD-007V-44P
Voltage	150V	20	42.7	TLPSD-007V-20P	46	88.2	TLPSD-007V-46P
Approval Bodies	UL	22	46.2	TLPSD-007V-22P	48	91.7	TLPSD-007V-48P
		24	49.7	TLPSD-007V-24P			
		26	53.2	TLPSD-007V-26P			
		28	56.7	TLPSD-007V-28P			

*xx = number of poles

PCB TERMINAL BLOCKS CABLE MOUNTING - PLUGGABLE (FEMALE)

TLPSW-002V-xxP

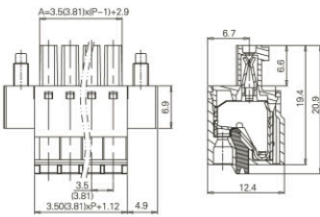

2-24 Pole Pluggable type Horizontal 3.5mm pitch

		N° of Poles	Pole Length (mm)	Product Code	N° of Poles	Pole Length (mm)	Product Code
Pitch (mm)	3.5	2	17.92	TLPSW-002V-02P	14	59.92	TLPSW-002V-14P
Wire Size AWG	Min: 24 / Max: 12	3	21.42	TLPSW-002V-03P	15	63.42	TLPSW-002V-15P
Wire Size (mm ²)	Min: 0.2 / Max: 4	4	24.92	TLPSW-002V-04P	16	66.92	TLPSW-002V-16P
PCB Hole Ø		5	28.42	TLPSW-002V-05P	17	70.42	TLPSW-002V-17P
Orientation	Horizontal	6	31.92	TLPSW-002V-06P	18	73.92	TLPSW-002V-18P
Mount Type	Horizontal	7	35.42	TLPSW-002V-07P	19	77.42	TLPSW-002V-19P
Join		8	38.92	TLPSW-002V-08P	20	80.92	TLPSW-002V-20P
Current	12A (UL)	9	42.42	TLPSW-002V-09P	21	84.42	TLPSW-002V-21P
Voltage	300V (UL)	10	45.92	TLPSW-002V-10P	22	87.92	TLPSW-002V-22P
Approval Bodies	UL	11	49.42	TLPSW-002V-11P	23	91.42	TLPSW-002V-23P
		12	52.92	TLPSW-002V-12P	24	94.92	TLPSW-002V-24P
		13	56.42	TLPSW-002V-13P			

TLPS-001R-xxP

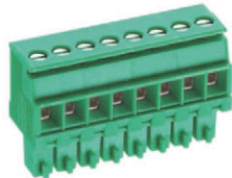
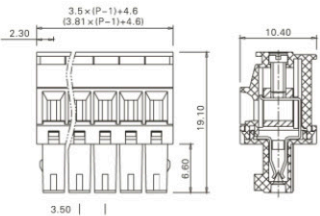

2-24 Pole Cable mount - Female plug Screw
Rising clamp Horizontal 3.5mm pitch

		N° of Poles	Pole Length (mm)	Product Code	N° of Poles	Pole Length (mm)	Product Code
Pitch (mm)	3.5	2	8.1	TLPS-001R-02P	14	50.1	TLPS-001R-14P
Wire Size AWG	Min: 30 / Max: 14	3	11.6	TLPS-001R-03P	15	53.6	TLPS-001R-15P
Wire Size (mm ²)	Max: 2.5	4	15.1	TLPS-001R-04P	16	57.1	TLPS-001R-16P
PCB Hole Ø		5	18.6	TLPS-001R-05P	17	60.6	TLPS-001R-17P
Orientation	Horizontal	6	22.1	TLPS-001R-06P	18	64.1	TLPS-001R-18P
Mount Type	Rising Clamp	7	25.6	TLPS-001R-07P	19	67.6	TLPS-001R-19P
Join		8	29.1	TLPS-001R-08P	20	71.1	TLPS-001R-20P
Current	8A (UL)	9	32.6	TLPS-001R-09P	21	74.6	TLPS-001R-21P
Voltage	300V (UL)	10	36.1	TLPS-001R-10P	22	78.1	TLPS-001R-22P
Approval Bodies	UL	11	39.6	TLPS-001R-11P	23	81.6	TLPS-001R-23P
		12	43.1	TLPS-001R-12P	24	85.1	TLPS-001R-24P
		13	46.6	TLPS-001R-13P			

TLPS-001RL-xxP

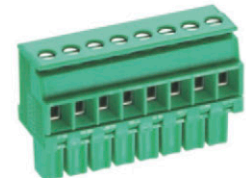
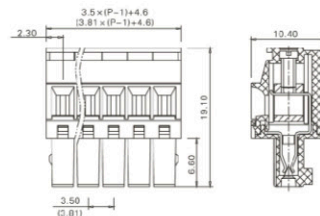

2-24 Pole Cable mount - Female plug Screw
Rising clamp Horizontal 3.5mm pitch

		N° of Poles	Pole Length (mm)	Product Code	N° of Poles	Pole Length (mm)	Product Code
Pitch (mm)	3.5	2	8.1	TLPS-001RL-02P	14	50.1	TLPS-001RL-14P
Wire Size AWG	Min: 30 / Max: 14	3	11.6	TLPS-001RL-03P	15	53.6	TLPS-001RL-15P
Wire Size (mm ²)	Max: 2.5	4	15.1	TLPS-001RL-04P	16	57.1	TLPS-001RL-16P
PCB Hole Ø		5	18.6	TLPS-001RL-05P	17	60.6	TLPS-001RL-17P
Orientation	Horizontal	6	22.1	TLPS-001RL-06P	18	64.1	TLPS-001RL-18P
Mount Type	Rising Clamp	7	25.6	TLPS-001RL-07P	19	67.6	TLPS-001RL-19P
Join		8	29.1	TLPS-001RL-08P	20	71.1	TLPS-001RL-20P
Current	8A (UL)	9	32.6	TLPS-001RL-09P	21	74.6	TLPS-001RL-21P
Voltage	300V (UL)	10	36.1	TLPS-001RL-10P	22	78.1	TLPS-001RL-22P
Approval Bodies	UL	11	39.6	TLPS-001RL-11P	23	81.6	TLPS-001RL-23P
		12	43.1	TLPS-001RL-12P	24	85.1	TLPS-001RL-24P
		13	46.6	TLPS-001RL-13P			

TLPSW-001R-xxP

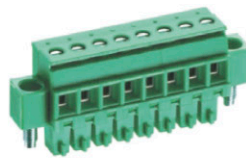
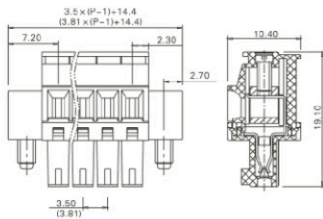

2-24 Pole Cable mount - Female plug Screw
Rising clamp Horizontal 3.5mm pitch

		N° of Poles	Pole Length (mm)	Product Code	N° of Poles	Pole Length (mm)	Product Code
Pitch (mm)	3.5	2	17.9	TLPSW-001R-02P	14	59.9	TLPSW-001R-14P
Wire Size AWG	Min: 30 / Max: 14	3	21.4	TLPSW-001R-03P	15	63.4	TLPSW-001R-15P
Wire Size (mm²)	Max: 2.5	4	24.9	TLPSW-001R-04P	16	66.9	TLPSW-001R-16P
PCB Hole Ø		5	28.4	TLPSW-001R-05P	17	70.4	TLPSW-001R-17P
Orientation	Horizontal	6	31.9	TLPSW-001R-06P	18	73.9	TLPSW-001R-18P
Mount Type	Rising Clamp	7	35.4	TLPSW-001R-07P	19	77.4	TLPSW-001R-19P
Join		8	38.9	TLPSW-001R-08P	20	80.9	TLPSW-001R-20P
Current	8A (UL)	9	42.4	TLPSW-001R-09P	21	84.4	TLPSW-001R-21P
Voltage	300V (UL)	10	45.9	TLPSW-001R-10P	22	87.9	TLPSW-001R-22P
Approval Bodies	UL	11	49.4	TLPSW-001R-11P	23	91.4	TLPSW-001R-23P
		12	52.9	TLPSW-001R-12P	24	94.9	TLPSW-001R-24P
		13	56.4	TLPSW-001R-13P			

TLPSW-001RL-xxP

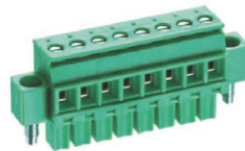
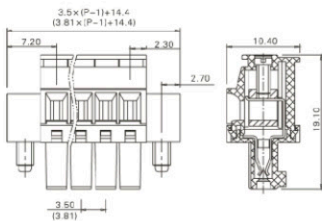

2-24 Pole Cable mount - Female plug Screw
Rising clamp Horizontal 3.5mm pitch

		N° of Poles	Pole Length (mm)	Product Code	N° of Poles	Pole Length (mm)	Product Code
Pitch (mm)	3.5	2	17.9	TLPSW-001RL-02P	14	59.9	TLPSW-001RL-14P
Wire Size AWG	Min: 30 / Max: 14	3	21.4	TLPSW-001RL-03P	15	63.4	TLPSW-001RL-15P
Wire Size (mm²)	Max: 2.5	4	24.9	TLPSW-001RL-04P	16	66.9	TLPSW-001RL-16P
PCB Hole Ø		5	28.4	TLPSW-001RL-05P	17	70.4	TLPSW-001RL-17P
Orientation	Horizontal	6	31.9	TLPSW-001RL-06P	18	73.9	TLPSW-001RL-18P
Mount Type	Rising Clamp	7	35.4	TLPSW-001RL-07P	19	77.4	TLPSW-001RL-19P
Join		8	38.9	TLPSW-001RL-08P	20	80.9	TLPSW-001RL-20P
Current	8A (UL)	9	42.4	TLPSW-001RL-09P	21	84.4	TLPSW-001RL-21P
Voltage	300V (UL)	10	45.9	TLPSW-001RL-10P	22	87.9	TLPSW-001RL-22P
Approval Bodies	UL	11	49.4	TLPSW-001RL-11P	23	91.4	TLPSW-001RL-23P
		12	52.9	TLPSW-001RL-12P	24	94.9	TLPSW-001RL-24P
		13	56.4	TLPSW-001RL-13P			

TLPS-001V-xxP

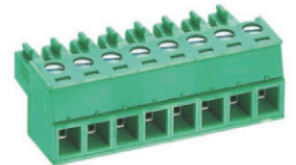
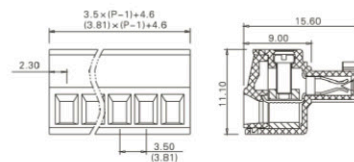

2-24 Pole Cable mount - Female plug Screw
Rising clamp Vertical 3.5mm pitch

		N° of Poles	Pole Length (mm)	Product Code	N° of Poles	Pole Length (mm)	Product Code
Pitch (mm)	3.5	2	8.1	TLPS-001V-02P	14	50.1	TLPS-001V-14P
Wire Size AWG	Min: 24 / Max: 14	3	11.6	TLPS-001V-03P	15	53.6	TLPS-001V-15P
Wire Size (mm²)	Min: 02 / Max: 2.5	4	15.1	TLPS-001V-04P	16	57.1	TLPS-001V-16P
PCB Hole Ø		5	18.6	TLPS-001V-05P	17	60.6	TLPS-001V-17P
Orientation	Vertical	6	22.1	TLPS-001V-06P	18	64.1	TLPS-001V-18P
Mount Type	Rising Clamp	7	25.6	TLPS-001V-07P	19	67.6	TLPS-001V-19P
Join		8	29.1	TLPS-001V-08P	20	71.1	TLPS-001V-20P
Current	8A (UL) / 10A (VDE)	9	32.6	TLPS-001V-09P	21	74.6	TLPS-001V-21P
Voltage	300V (UL) / 150V (VDE)	10	36.1	TLPS-001V-10P	22	78.1	TLPS-001V-22P
Approval Bodies	UL, CE, c, RUS	11	39.6	TLPS-001V-11P	23	81.6	TLPS-001V-23P
		12	43.1	TLPS-001V-12P	24	85.1	TLPS-001V-24P
		13	46.6	TLPS-001V-13P			

*xx = number of poles

PCB TERMINAL BLOCKS CABLE MOUNTING - PLUGGABLE (FEMALE)

TLPSW-001V-xxP

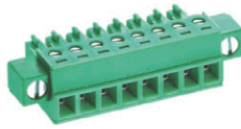
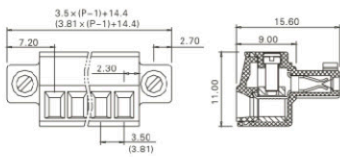

2-24 Pole Cable mount - Female plug Screw
Rising clamp Vertical 3.5mm pitch

		N° of Poles	Pole Length (mm)	Product Code	N° of Poles	Pole Length (mm)	Product Code
Pitch (mm)	3.5	2	17.9	TLPSW-001V-02P	14	59.9	TLPSW-001V-14P
Wire Size AWG	Min: 24 / Max: 14	3	21.4	TLPSW-001V-03P	15	63.4	TLPSW-001V-15P
Wire Size (mm ²)	Min: 0.2 / Max: 2.5	4	24.9	TLPSW-001V-04P	16	66.9	TLPSW-001V-16P
PCB Hole Ø		5	28.4	TLPSW-001V-05P	17	70.4	TLPSW-001V-17P
Orientation	Vertical	6	31.9	TLPSW-001V-06P	18	73.9	TLPSW-001V-18P
Mount Type	Rising Clamp	7	35.4	TLPSW-001V-07P	19	77.4	TLPSW-001V-19P
Join		8	38.9	TLPSW-001V-08P	20	80.9	TLPSW-001V-20P
Current	8A (UL) / 10A (VDE)	9	42.4	TLPSW-001V-09P	21	84.4	TLPSW-001V-21P
Voltage	300V (UL) / 150V (VDE)	10	45.9	TLPSW-001V-10P	22	87.9	TLPSW-001V-22P
Approval Bodies		11	49.4	TLPSW-001V-11P	23	91.4	TLPSW-001V-23P
		12	52.9	TLPSW-001V-12P	24	94.9	TLPSW-001V-24P
		13	56.4	TLPSW-001V-13P			

TLPS-101V-xxP

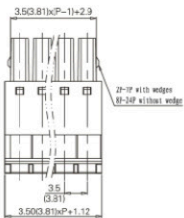

2-24 Pole Pluggable type Horizontal
3.81mm pitch

		N° of Poles	Pole Length (mm)	Product Code	N° of Poles	Pole Length (mm)	Product Code
Pitch (mm)	3.81	2	6.71	TLPS-101V-02P	14	52.43	TLPS-101V-14P
Wire Size AWG	Min: 24 / Max: 12	3	10.52	TLPS-101V-03P	15	56.24	TLPS-101V-15P
Wire Size (mm ²)	Min: 0.2 / Max: 4	4	14.33	TLPS-101V-04P	16	60.05	TLPS-101V-16P
PCB Hole Ø		5	18.14	TLPS-101V-05P	17	63.86	TLPS-101V-17P
Orientation	Horizontal	6	21.95	TLPS-101V-06P	18	67.67	TLPS-101V-18P
Mount Type	Horizontal	7	25.76	TLPS-101V-07P	19	71.48	TLPS-101V-19P
Join		8	29.57	TLPS-101V-08P	20	75.29	TLPS-101V-20P
Current	12A (UL)	9	33.38	TLPS-101V-09P	21	79.1	TLPS-101V-21P
Voltage	300V (UL)	10	37.19	TLPS-101V-10P	22	82.91	TLPS-101V-22P
Approval Bodies		11	41	TLPS-101V-11P	23	86.72	TLPS-101V-23P
		12	44.81	TLPS-101V-12P	24	90.53	TLPS-101V-24P
		13	48.62	TLPS-101V-13P			

TLPSW-101V-xxP

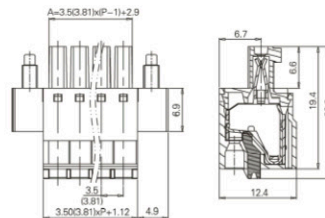

2-24 Pole Pluggable type Horizontal
3.81mm pitch

		N° of Poles	Pole Length (mm)	Product Code	N° of Poles	Pole Length (mm)	Product Code
Pitch (mm)	3.81	2	18.54	TLPSW-101V-02P	14	64.26	TLPSW-101V-14P
Wire Size AWG	Min: 24 / Max: 12	3	22.35	TLPSW-101V-03P	15	68.07	TLPSW-101V-15P
Wire Size (mm ²)	Min: 0.2 / Max: 4	4	26.16	TLPSW-101V-04P	16	71.88	TLPSW-101V-16P
PCB Hole Ø		5	29.97	TLPSW-101V-05P	17	75.69	TLPSW-101V-17P
Orientation	Horizontal	6	33.78	TLPSW-101V-06P	18	79.5	TLPSW-101V-18P
Mount Type	Horizontal	7	37.59	TLPSW-101V-07P	19	83.31	TLPSW-101V-19P
Join		8	41.4	TLPSW-101V-08P	20	87.12	TLPSW-101V-20P
Current	12A (UL)	9	45.21	TLPSW-101V-09P	21	90.93	TLPSW-101V-21P
Voltage	300V (UL)	10	49.02	TLPSW-101V-10P	22	94.74	TLPSW-101V-22P
Approval Bodies		11	52.83	TLPSW-101V-11P	23	98.55	TLPSW-101V-23P
		12	56.64	TLPSW-101V-12P	24	102.36	TLPSW-101V-24P
		13	60.45	TLPSW-101V-13P			

TLPS-100R-xxP

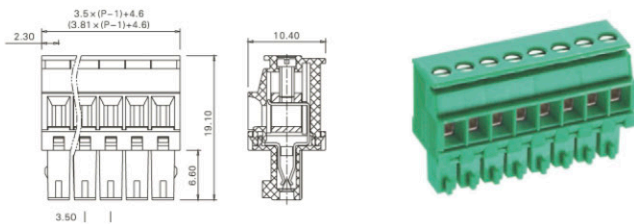

2-24 Pole Cable mount - Female plug Screw
Rising clamp Horizontal 3.81mm pitch

		N° of Poles	Pole Length (mm)	Product Code	N° of Poles	Pole Length (mm)	Product Code
Pitch (mm)	3.81	2	8.41	TLPS-100R-02P	14	54.13	TLPS-100R-14P
Wire Size AWG	Min: 30 / Max: 14	3	12.22	TLPS-100R-03P	15	57.94	TLPS-100R-15P
Wire Size (mm²)	Max: 2.5	4	16.03	TLPS-100R-04P	16	61.75	TLPS-100R-16P
PCB Hole Ø		5	19.84	TLPS-100R-05P	17	65.56	TLPS-100R-17P
Orientation	Horizontal	6	23.65	TLPS-100R-06P	18	69.37	TLPS-100R-18P
Mount Type	Rising Clamp	7	27.46	TLPS-100R-07P	19	73.18	TLPS-100R-19P
Join		8	31.27	TLPS-100R-08P	20	76.99	TLPS-100R-20P
Current	8A (UL)	9	35.08	TLPS-100R-09P	21	80.8	TLPS-100R-21P
Voltage	300V (UL)	10	38.89	TLPS-100R-10P	22	84.61	TLPS-100R-22P
Approval Bodies		11	42.7	TLPS-100R-11P	23	88.42	TLPS-100R-23P
		12	46.51	TLPS-100R-12P	24	92.23	TLPS-100R-24P
		13	50.32	TLPS-100R-13P			

TLPS-100RL-xxP

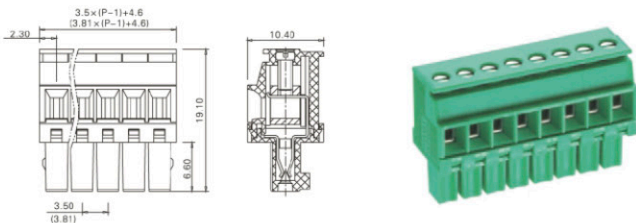

TLPSW-100R-xxP

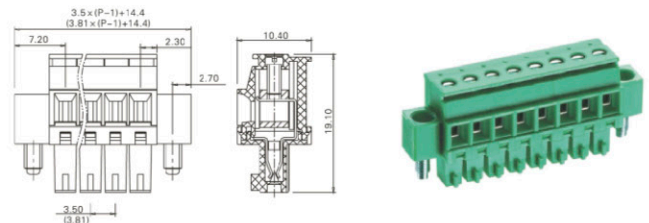

2-24 Pole Cable mount - Female plug Screw
Rising clamp Horizontal 3.81mm pitch

		N° of Poles	Pole Length (mm)	Product Code	N° of Poles	Pole Length (mm)	Product Code
Pitch (mm)	3.81	2	8.41	TLPS-100RL-02P	14	54.13	TLPS-100RL-14P
Wire Size AWG	Min: 30 / Max: 14	3	12.22	TLPS-100RL-03P	15	57.94	TLPS-100RL-15P
Wire Size (mm²)	Max: 2.5	4	16.03	TLPS-100RL-04P	16	61.75	TLPS-100RL-16P
PCB Hole Ø		5	19.84	TLPS-100RL-05P	17	65.56	TLPS-100RL-17P
Orientation	Horizontal	6	23.65	TLPS-100RL-06P	18	69.37	TLPS-100RL-18P
Mount Type	Rising Clamp	7	27.46	TLPS-100RL-07P	19	73.18	TLPS-100RL-19P
Join		8	31.27	TLPS-100RL-08P	20	76.99	TLPS-100RL-20P
Current	8A (UL)	9	35.08	TLPS-100RL-09P	21	80.8	TLPS-100RL-21P
Voltage	300V (UL)	10	38.89	TLPS-100RL-10P	22	84.61	TLPS-100RL-22P
Approval Bodies		11	42.7	TLPS-100RL-11P	23	88.42	TLPS-100RL-23P
		12	46.51	TLPS-100RL-12P	24	92.23	TLPS-100RL-24P
		13	50.32	TLPS-100RL-13P			

2-24 Pole Cable mount - Female plug Screw
Rising clamp Horizontal 3.81mm pitch

		N° of Poles	Pole Length (mm)	Product Code	N° of Poles	Pole Length (mm)	Product Code
Pitch (mm)	3.81	2	18.21	TLPSW-100R-02P	14	63.93	TLPSW-100R-14P
Wire Size AWG	Min: 30 / Max: 14	3	22.02	TLPSW-100R-03P	15	67.74	TLPSW-100R-15P
Wire Size (mm²)	Max: 2.5	4	25.83	TLPSW-100R-04P	16	71.55	TLPSW-100R-16P
PCB Hole Ø		5	29.64	TLPSW-100R-05P	17	75.36	TLPSW-100R-17P
Orientation	Horizontal	6	33.45	TLPSW-100R-06P	18	79.17	TLPSW-100R-18P
Mount Type	Rising Clamp	7	37.26	TLPSW-100R-07P	19	82.98	TLPSW-100R-19P
Join		8	41.07	TLPSW-100R-08P	20	86.79	TLPSW-100R-20P
Current	8A (UL)	9	44.88	TLPSW-100R-09P	21	90.6	TLPSW-100R-21P
Voltage	300V (UL)	10	48.69	TLPSW-100R-10P	22	94.41	TLPSW-100R-22P
Approval Bodies		11	52.5	TLPSW-100R-11P	23	98.22	TLPSW-100R-23P
		12	56.31	TLPSW-100R-12P	24	102.03	TLPSW-100R-24P
		13	60.12	TLPSW-100R-13P			

*xx = number of poles

PCB TERMINAL BLOCKS CABLE MOUNTING - PLUGGABLE (FEMALE)

TLPSW-100RL-xxP

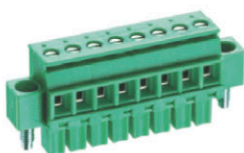
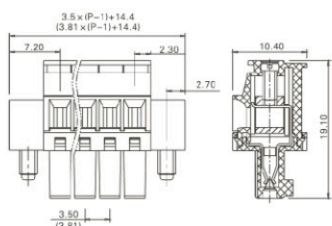

2-24 Pole Cable mount - Female plug Screw
Rising clamp Horizontal 3.81mm pitch

		N° of Poles	Pole Length (mm)	Product Code	N° of Poles	Pole Length (mm)	Product Code
Pitch (mm)	3.81	2	18.21	TLPSW-100RL-02P	14	63.93	TLPSW-100RL-14P
Wire Size AWG	Min: 30 / Max: 14	3	22.02	TLPSW-100RL-03P	15	67.74	TLPSW-100RL-15P
Wire Size (mm²)	Max: 2.5	4	25.83	TLPSW-100RL-04P	16	71.55	TLPSW-100RL-16P
PCB Hole Ø		5	29.64	TLPSW-100RL-05P	17	75.36	TLPSW-100RL-17P
Orientation	Horizontal	6	33.45	TLPSW-100RL-06P	18	79.17	TLPSW-100RL-18P
Mount Type	Rising Clamp	7	37.26	TLPSW-100RL-07P	19	82.98	TLPSW-100RL-19P
Join		8	41.07	TLPSW-100RL-08P	20	86.79	TLPSW-100RL-20P
Current	8A (UL)	9	44.88	TLPSW-100RL-09P	21	90.6	TLPSW-100RL-21P
Voltage	300V (UL)	10	48.69	TLPSW-100RL-10P	22	94.41	TLPSW-100RL-22P
Approval Bodies		11	52.5	TLPSW-100RL-11P	23	98.22	TLPSW-100RL-23P
		12	56.31	TLPSW-100RL-12P	24	102.03	TLPSW-100RL-24P
		13	60.12	TLPSW-100RL-13P			

TLPS-100V-xxP

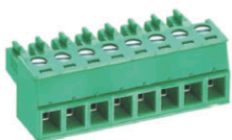
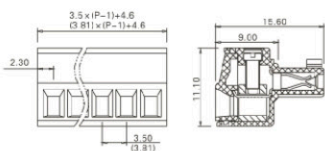

2-24 Pole Cable mount - Female plug Screw
Rising clamp Vertical 3.81mm pitch

		N° of Poles	Pole Length (mm)	Product Code	N° of Poles	Pole Length (mm)	Product Code
Pitch (mm)	3.81	2	8.41	TLPS-100V-02P	14	54.13	TLPS-100V-14P
Wire Size AWG	Min: 24 / Max: 14	3	12.22	TLPS-100V-03P	15	57.94	TLPS-100V-15P
Wire Size (mm²)	Min: 0.2 / Max: 2.5	4	16.03	TLPS-100V-04P	16	61.75	TLPS-100V-16P
PCB Hole Ø		5	19.84	TLPS-100V-05P	17	65.56	TLPS-100V-17P
Orientation	Vertical	6	23.65	TLPS-100V-06P	18	69.37	TLPS-100V-18P
Mount Type	Rising Clamp	7	27.46	TLPS-100V-07P	19	73.18	TLPS-100V-19P
Join		8	31.27	TLPS-100V-08P	20	76.99	TLPS-100V-20P
Current	8A (UL) / 10A (VDE)	9	35.08	TLPS-100V-09P	21	80.8	TLPS-100V-21P
Voltage	300V (UL) / 150V (VDE)	10	38.89	TLPS-100V-10P	22	84.61	TLPS-100V-22P
Approval Bodies		11	42.7	TLPS-100V-11P	23	88.42	TLPS-100V-23P
		12	46.51	TLPS-100V-12P	24	92.23	TLPS-100V-24P
		13	50.32	TLPS-100V-13P			

TLPSW-100V-xxP

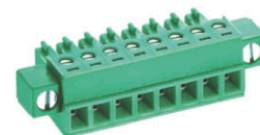
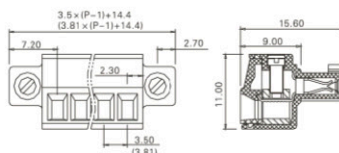

2-24 Pole Cable mount - Female plug Screw
Rising clamp Vertical 3.81mm pitch

		N° of Poles	Pole Length (mm)	Product Code	N° of Poles	Pole Length (mm)	Product Code
Pitch (mm)	3.81	2	18.21	TLPSW-100R-02P	14	63.93	TLPSW-100R-14P
Wire Size AWG	Min: 24 / Max: 14	3	22.02	TLPSW-100R-03P	15	67.74	TLPSW-100R-15P
Wire Size (mm²)	Min: 0.2 / Max: 2.5	4	25.83	TLPSW-100R-04P	16	71.55	TLPSW-100R-16P
PCB Hole Ø		5	29.64	TLPSW-100R-05P	17	75.36	TLPSW-100R-17P
Orientation	Vertical	6	33.45	TLPSW-100R-06P	18	79.17	TLPSW-100R-18P
Mount Type	Rising Clamp	7	37.26	TLPSW-100R-07P	19	82.98	TLPSW-100R-19P
Join		8	41.07	TLPSW-100R-08P	20	86.79	TLPSW-100R-20P
Current	8A (UL) / 10A (VDE)	9	44.88	TLPSW-100R-09P	21	90.6	TLPSW-100R-21P
Voltage	300V (UL) / 150V (VDE)	10	48.69	TLPSW-100R-10P	22	94.41	TLPSW-100R-22P
Approval Bodies		11	52.5	TLPSW-100R-11P	23	98.22	TLPSW-100R-23P
		12	56.31	TLPSW-100R-12P	24	102.03	TLPSW-100R-24P
		13	60.12	TLPSW-100R-13P			

TL205T-xxPKS

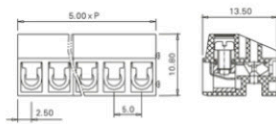

2-24 Pole Cable mount - Female plug Screw
Rising clamp Horizontal 5mm pitch

		N° of Poles	Pole Length (mm)	Product Code	N° of Poles	Pole Length (mm)	Product Code
Pitch (mm)	5	2	10	TL205T-02PKS	14	70	TL205T-14PKS
Wire Size AWG	Min: 24 / Max: 14	3	15	TL205T-03PKS	15	75	TL205T-15PKS
Wire Size (mm²)	Min: 0.2 / Max: 2.5	4	20	TL205T-04PKS	16	80	TL205T-16PKS
PCB Hole Ø		5	25	TL205T-05PKS	17	85	TL205T-17PKS
Orientation	Vertical	6	30	TL205T-06PKS	18	90	TL205T-18PKS
Mount Type	Screw	7	35	TL205T-07PKS	19	95	TL205T-19PKS
Join	Interlocking	8	40	TL205T-08PKS	20	100	TL205T-20PKS
Current	10A (UL)	9	45	TL205T-09PKS	21	105	TL205T-21PKS
Voltage	300V (UL)	10	50	TL205T-10PKS	22	110	TL205T-22PKS
Approval Bodies		11	55	TL205T-11PKS	23	115	TL205T-23PKS
		12	60	TL205T-12PKS	24	120	TL205T-24PKS
		13	65	TL205T-13PKS			

TL221T-xxPKS

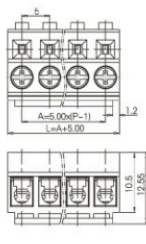

2-24 Pole Wire Protector Vertical 5mm pitch

		N° of Poles	Pole Length (mm)	Product Code	N° of Poles	Pole Length (mm)	Product Code
Pitch (mm)	5	2	10	TL221T-02PKS	14	70	TL221T-14PKS
Wire Size AWG	Min: 24 / Max: 14	3	15	TL221T-03PKS	15	75	TL221T-15PKS
Wire Size (mm²)	Min: 0.2 / Max: 2.5	4	20	TL221T-04PKS	16	80	TL221T-16PKS
PCB Hole Ø		5	25	TL221T-05PKS	17	85	TL221T-17PKS
Orientation	Vertical	6	30	TL221T-06PKS	18	90	TL221T-18PKS
Mount Type	Wire Protector	7	35	TL221T-07PKS	19	95	TL221T-19PKS
Join	Solid body non stackable	8	40	TL221T-08PKS	20	100	TL221T-20PKS
Current	10A (UL)	9	45	TL221T-09PKS	21	105	TL221T-21PKS
Voltage	300V (UL)	10	50	TL221T-10PKS	22	110	TL221T-22PKS
Approval Bodies		11	55	TL221T-11PKS	23	115	TL221T-23PKS
		12	60	TL221T-12PKS	24	120	TL221T-24PKS
		13	65	TL221T-13PKS			

TL222T-xxPKS

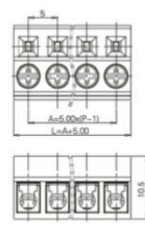

2-24 Pole Wire Protector Vertical 5mm pitch

		N° of Poles	Pole Length (mm)	Product Code	N° of Poles	Pole Length (mm)	Product Code
Pitch (mm)	5	2	20	TL222T-02PKS	14	80	TL222T-14PKS
Wire Size AWG	Min: 24 / Max: 14	3	25	TL222T-03PKS	15	85	TL222T-15PKS
Wire Size (mm²)	Min: 0.2 / Max: 2.5	4	30	TL222T-04PKS	16	90	TL222T-16PKS
PCB Hole Ø		5	35	TL222T-05PKS	17	95	TL222T-17PKS
Orientation	Vertical	6	40	TL222T-06PKS	18	100	TL222T-18PKS
Mount Type	Wire Protector	7	45	TL222T-07PKS	19	105	TL222T-19PKS
Join	Solid body non stackable	8	50	TL222T-08PKS	20	110	TL222T-20PKS
Current	10A (UL)	9	55	TL222T-09PKS	21	115	TL222T-21PKS
Voltage	300V (UL)	10	60	TL222T-10PKS	22	120	TL222T-22PKS
Approval Bodies		11	65	TL222T-11PKS	23	125	TL222T-23PKS
		12	70	TL222T-12PKS	24	130	TL222T-24PKS
		13	75	TL222T-13PKS			

*xx = number of poles

PCB TERMINAL BLOCKS CABLE MOUNTING - PLUGGABLE (FEMALE)

TL223T-xxPKS

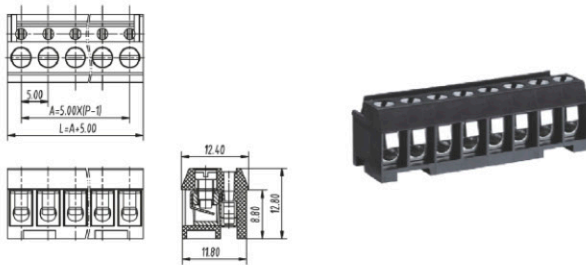

		2-24 Pole Wire Protector Vertical 5mm pitch		N° of Poles	Pole Length (mm)	Product Code	N° of Poles	Pole Length (mm)	Product Code
Pitch (mm)	5	2	10	TL223T-02PKS	14	70	TL223T-14PKS		
Wire Size AWG	Min: 26 / Max: 12	3	15	TL223T-03PKS	15	75	TL223T-15PKS		
Wire Size (mm ²)	Min: 0.2 / Max: 4	4	20	TL223T-04PKS	16	80	TL223T-16PKS		
PCB Hole Ø		5	25	TL223T-05PKS	17	85	TL223T-17PKS		
Orientation	Vertical	6	30	TL223T-06PKS	18	90	TL223T-18PKS		
Mount Type	Wire Protector	7	35	TL223T-07PKS	19	95	TL223T-19PKS		
Join	Solid body non stackable	8	40	TL223T-08PKS	20	100	TL223T-20PKS		
Current	12A (UL)	9	45	TL223T-09PKS	21	105	TL223T-21PKS		
Voltage	300V (UL)	10	50	TL223T-10PKS	22	110	TL223T-22PKS		
Approval Bodies		11	55	TL223T-11PKS	23	115	TL223T-23PKS		
		12	60	TL223T-12PKS	24	120	TL223T-24PKS		
		13	65	TL223T-13PKS					

TLPS-201V-xxP

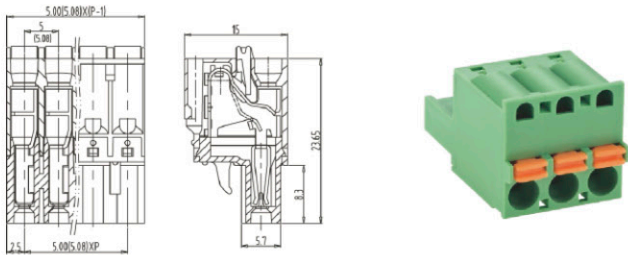

		2-24 Pole Pluggable type Horizontal 5mm pitch		N° of Poles	Pole Length (mm)	Product Code	N° of Poles	Pole Length (mm)	Product Code
Pitch (mm)	5	2	10	TLPS-201V-02P	14	70	TLPS-201V-14P		
Wire Size AWG	Min: 24 / Max: 12	3	15	TLPS-201V-03P	15	75	TLPS-201V-15P		
Wire Size (mm ²)	Min: 0.2 / Max: 4	4	20	TLPS-201V-04P	16	80	TLPS-201V-16P		
PCB Hole Ø		5	25	TLPS-201V-05P	17	85	TLPS-201V-17P		
Orientation	Horizontal	6	30	TLPS-201V-06P	18	90	TLPS-201V-18P		
Mount Type	Horizontal	7	35	TLPS-201V-07P	19	95	TLPS-201V-19P		
Join		8	40	TLPS-201V-08P	20	100	TLPS-201V-20P		
Current	12A (UL)	9	45	TLPS-201V-09P	21	105	TLPS-201V-21P		
Voltage	300V (UL)	10	50	TLPS-201V-10P	22	110	TLPS-201V-22P		
Approval Bodies	UL	11	55	TLPS-201V-11P	23	115	TLPS-201V-23P		
		12	60	TLPS-201V-12P	24	120	TLPS-201V-24P		
		13	65	TLPS-201V-13P					

TLPS-225-xxP

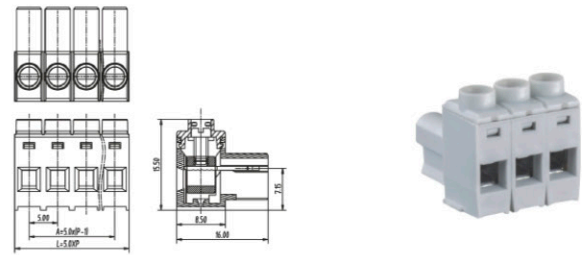

		2-24 Pole Pluggable type Horizontal 5mm pitch		N° of Poles	Pole Length (mm)	Product Code	N° of Poles	Pole Length (mm)	Product Code
Pitch (mm)	5	2	10	TLPS-225-02P	14	70	TLPS-225-14P		
Wire Size AWG	Min: 26 / Max: 12	3	15	TLPS-225-03P	15	75	TLPS-225-15P		
Wire Size (mm ²)	Min: 0.2 / Max: 4	4	20	TLPS-225-04P	16	80	TLPS-225-16P		
PCB Hole Ø		5	25	TLPS-225-05P	17	85	TLPS-225-17P		
Orientation	Horizontal	6	30	TLPS-225-06P	18	90	TLPS-225-18P		
Mount Type	Horizontal	7	35	TLPS-225-07P	19	95	TLPS-225-19P		
Join		8	40	TLPS-225-08P	20	100	TLPS-225-20P		
Current	15A (UL)	9	45	TLPS-225-09P	21	105	TLPS-225-21P		
Voltage	300V (UL)	10	50	TLPS-225-10P	22	110	TLPS-225-22P		
Approval Bodies	UL	11	55	TLPS-225-11P	23	115	TLPS-225-23P		
		12	60	TLPS-225-12P	24	120	TLPS-225-24P		
		13	65	TLPS-225-13P					

*xx = number of poles

TLPSW-201V-xxP

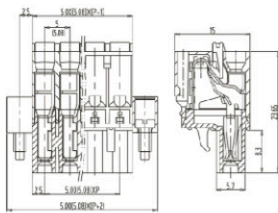

2-24 Pole Pluggable type Horizontal 5mm pitch

		N° of Poles	Pole Length (mm)	Product Code	N° of Poles	Pole Length (mm)	Product Code
Pitch (mm)	5	2	20	TLPSW-201V-02P	14	80	TLPSW-201V-14P
Wire Size AWG	Min: 24 / Max: 12	3	25	TLPSW-201V-03P	15	85	TLPSW-201V-15P
Wire Size (mm ²)	Min: 0.2 / Max: 4	4	30	TLPSW-201V-04P	16	90	TLPSW-201V-16P
PCB Hole Ø		5	35	TLPSW-201V-05P	17	95	TLPSW-201V-17P
Orientation	Horizontal	6	40	TLPSW-201V-06P	18	100	TLPSW-201V-18P
Mount Type	Horizontal	7	45	TLPSW-201V-07P	19	105	TLPSW-201V-19P
Join		8	50	TLPSW-201V-08P	20	110	TLPSW-201V-20P
Current	12A (UL)	9	55	TLPSW-201V-09P	21	115	TLPSW-201V-21P
Voltage	300V (UL)	10	60	TLPSW-201V-10P	22	120	TLPSW-201V-22P
Approval Bodies	UL	11	65	TLPSW-201V-11P	23	125	TLPSW-201V-23P
		12	70	TLPSW-201V-12P	24	130	TLPSW-201V-24P
		13	75	TLPSW-201V-13P			

TLPS-200R-xxP

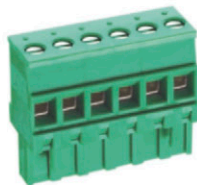
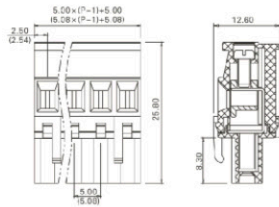

TLPS-200RL-xxP

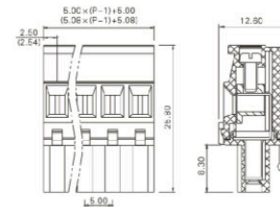

2-24 Pole Cable mount - Female plug Screw
Rising clamp Horizontal 5mm pitch

		N° of Poles	Pole Length (mm)	Product Code	N° of Poles	Pole Length (mm)	Product Code
Pitch (mm)	5	2	10	TLPS-200R-02P	14	70	TLPS-200R-14P
Wire Size AWG	Min: 30 / Max: 12	3	15	TLPS-200R-03P	15	75	TLPS-200R-15P
Wire Size (mm ²)	Max: 4	4	20	TLPS-200R-04P	16	80	TLPS-200R-16P
PCB Hole Ø		5	25	TLPS-200R-05P	17	85	TLPS-200R-17P
Orientation	Horizontal	6	30	TLPS-200R-06P	18	90	TLPS-200R-18P
Mount Type	Rising Clamp	7	35	TLPS-200R-07P	19	95	TLPS-200R-19P
Join		8	40	TLPS-200R-08P	20	100	TLPS-200R-20P
Current	16A (UL)	9	45	TLPS-200R-09P	21	105	TLPS-200R-21P
Voltage	300V (UL)	10	50	TLPS-200R-10P	22	110	TLPS-200R-22P
Approval Bodies	UL	11	55	TLPS-200R-11P	23	115	TLPS-200R-23P
		12	60	TLPS-200R-12P	24	120	TLPS-200R-24P
		13	65	TLPS-200R-13P			

2-24 Pole Cable mount - Female plug Screw
Rising clamp Horizontal 5mm pitch

		N° of Poles	Pole Length (mm)	Product Code	N° of Poles	Pole Length (mm)	Product Code
Pitch (mm)	5	2	10	TLPS-200RL-02P	14	70	TLPS-200RL-14P
Wire Size AWG	Min: 30 / Max: 12	3	15	TLPS-200RL-03P	15	75	TLPS-200RL-15P
Wire Size (mm ²)	Max: 4	4	20	TLPS-200RL-04P	16	80	TLPS-200RL-16P
PCB Hole Ø		5	25	TLPS-200RL-05P	17	85	TLPS-200RL-17P
Orientation	Horizontal	6	30	TLPS-200RL-06P	18	90	TLPS-200RL-18P
Mount Type	Rising Clamp	7	35	TLPS-200RL-07P	19	95	TLPS-200RL-19P
Join		8	40	TLPS-200RL-08P	20	100	TLPS-200RL-20P
Current	16A (UL)	9	45	TLPS-200RL-09P	21	105	TLPS-200RL-21P
Voltage	300V (UL)	10	50	TLPS-200RL-10P	22	110	TLPS-200RL-22P
Approval Bodies	UL	11	55	TLPS-200RL-11P	23	115	TLPS-200RL-23P
		12	60	TLPS-200RL-12P	24	120	TLPS-200RL-24P
		13	65	TLPS-200RL-13P			

*xx = number of poles

PCB TERMINAL BLOCKS CABLE MOUNTING - PLUGGABLE (FEMALE)

TLPS-200V-xxP

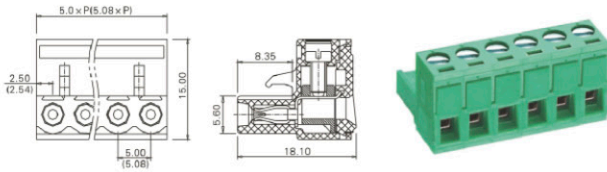

2-24 Pole Cable mount - Female plug Screw
Rising clamp Vertical 5mm pitch

		N° of Poles	Pole Length (mm)	Product Code	N° of Poles	Pole Length (mm)	Product Code			
Pitch (mm)	5	2	10	TLPS-200V-02P	14	70	TLPS-200V-14P			
Wire Size AWG	Min: 28 / Max: 12	3	15	TLPS-200V-03P	15	75	TLPS-200V-15P			
Wire Size (mm ²)	Min: 0.75 / Max: 2.5	4	20	TLPS-200V-04P	16	80	TLPS-200V-16P			
PCB Hole Ø		5	25	TLPS-200V-05P	17	85	TLPS-200V-17P			
Orientation	Horizontal	6	30	TLPS-200V-06P	18	90	TLPS-200V-18P			
Mount Type	Rising Clamp	7	35	TLPS-200V-07P	19	95	TLPS-200V-19P			
Join		8	40	TLPS-200V-08P	20	100	TLPS-200V-20P			
Current	16A (UL) / 15A (VDE)	9	45	TLPS-200V-09P	21	105	TLPS-200V-21P			
Voltage	300V (UL) / 250V (VDE)	10	50	TLPS-200V-10P	22	110	TLPS-200V-22P			
Approval Bodies		11	55	TLPS-200V-11P	23	115	TLPS-200V-23P			
					12	60	TLPS-200V-12P	24	120	TLPS-200V-24P
					13	65	TLPS-200V-13P			

TLPSW-200R-xxP

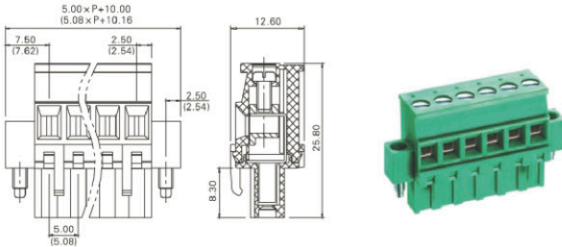

2-24 Pole Cable mount - Female plug Screw
Rising clamp Horizontal 5mm pitch

		N° of Poles	Pole Length (mm)	Product Code	N° of Poles	Pole Length (mm)	Product Code			
Pitch (mm)	5	2	20	TLPSW-200R-02P	14	80	TLPSW-200R-14P			
Wire Size AWG	Min: 30 / Max: 12	3	25	TLPSW-200R-03P	15	85	TLPSW-200R-15P			
Wire Size (mm ²)	Max: 4	4	30	TLPSW-200R-04P	16	90	TLPSW-200R-16P			
PCB Hole Ø		5	35	TLPSW-200R-05P	17	95	TLPSW-200R-17P			
Orientation	Horizontal	6	40	TLPSW-200R-06P	18	100	TLPSW-200R-18P			
Mount Type	Rising Clamp	7	45	TLPSW-200R-07P	19	105	TLPSW-200R-19P			
Join		8	50	TLPSW-200R-08P	20	110	TLPSW-200R-20P			
Current	16A (UL)	9	55	TLPSW-200R-09P	21	115	TLPSW-200R-21P			
Voltage	300V (UL)	10	60	TLPSW-200R-10P	22	120	TLPSW-200R-22P			
Approval Bodies		11	65	TLPSW-200R-11P	23	125	TLPSW-200R-23P			
					12	70	TLPSW-200R-12P	24	130	TLPSW-200R-24P
					13	75	TLPSW-200R-13P			

TLPSW-200RL-xxP

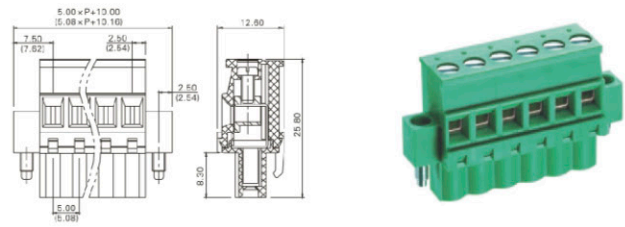

2-24 Pole Cable mount - Female plug Screw
Rising clamp Horizontal 5mm pitch

		N° of Poles	Pole Length (mm)	Product Code	N° of Poles	Pole Length (mm)	Product Code			
Pitch (mm)	5	2	20	TLPSW-200RL-02P	14	80	TLPSW-200RL-14P			
Wire Size AWG	Min: 30 / Max: 12	3	25	TLPSW-200RL-03P	15	85	TLPSW-200RL-15P			
Wire Size (mm ²)	Max: 4	4	30	TLPSW-200RL-04P	16	90	TLPSW-200RL-16P			
PCB Hole Ø		5	35	TLPSW-200RL-05P	17	95	TLPSW-200RL-17P			
Orientation	Horizontal	6	40	TLPSW-200RL-06P	18	100	TLPSW-200RL-18P			
Mount Type	Rising Clamp	7	45	TLPSW-200RL-07P	19	105	TLPSW-200RL-19P			
Join		8	50	TLPSW-200RL-08P	20	110	TLPSW-200RL-20P			
Current	16A (UL)	9	55	TLPSW-200RL-09P	21	115	TLPSW-200RL-21P			
Voltage	300V (UL)	10	60	TLPSW-200RL-10P	22	120	TLPSW-200RL-22P			
Approval Bodies		11	65	TLPSW-200RL-11P	23	125	TLPSW-200RL-23P			
					12	70	TLPSW-200RL-12P	24	130	TLPSW-200RL-24P
					13	75	TLPSW-200RL-13P			

TLPSW-200V-xxP

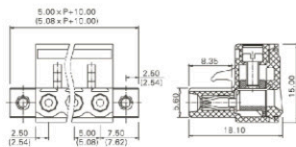

2-24 Pole Cable mount - Female plug Screw Rising clamp Vertical 5mm pitch

		N° of Poles	Pole Length (mm)	Product Code	N° of Poles	Pole Length (mm)	Product Code
Pitch (mm)	5	2	20	TLPSW-200V-02P	14	80	TLPSW-200V-14P
Wire Size AWG	Min: 28 / Max: 12	3	25	TLPSW-200V-03P	15	85	TLPSW-200V-15P
Wire Size (mm ²)	Min: 0.75 / Max: 2.5	4	30	TLPSW-200V-04P	16	90	TLPSW-200V-16P
PCB Hole Ø		5	35	TLPSW-200V-05P	17	95	TLPSW-200V-17P
Orientation	Vertical	6	40	TLPSW-200V-06P	18	100	TLPSW-200V-18P
Mount Type	Rising Clamp	7	45	TLPSW-200V-07P	19	105	TLPSW-200V-19P
Join		8	50	TLPSW-200V-08P	20	110	TLPSW-200V-20P
Current	16A (UL)	9	55	TLPSW-200V-09P	21	115	TLPSW-200V-21P
Voltage	300V (UL)	10	60	TLPSW-200V-10P	22	120	TLPSW-200V-22P
Approval Bodies		11	65	TLPSW-200V-11P	23	125	TLPSW-200V-23P
		12	70	TLPSW-200V-12P	24	130	TLPSW-200V-24P
		13	75	TLPSW-200V-13P			

TLPS-302V-xxP

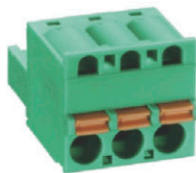
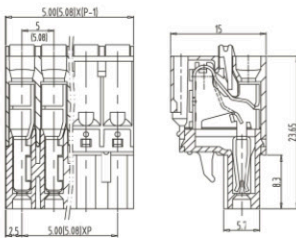

2-24 Pole Pluggable type Horizontal 5.08mm pitch

		N° of Poles	Pole Length (mm)	Product Code	N° of Poles	Pole Length (mm)	Product Code
Pitch (mm)	5.08	2	10.16	TLPS-302V-02P	14	71.12	TLPS-302V-14P
Wire Size AWG	Min: 24 / Max: 12	3	15.24	TLPS-302V-03P	15	76.2	TLPS-302V-15P
Wire Size (mm ²)	Min: 0.2 / Max: 4	4	20.32	TLPS-302V-04P	16	81.28	TLPS-302V-16P
PCB Hole Ø		5	25.4	TLPS-302V-05P	17	86.36	TLPS-302V-17P
Orientation	Horizontal	6	30.48	TLPS-302V-06P	18	91.44	TLPS-302V-18P
Mount Type	Horizontal	7	35.56	TLPS-302V-07P	19	96.52	TLPS-302V-19P
Join		8	40.64	TLPS-302V-08P	20	101.6	TLPS-302V-20P
Current	16A (UL)	9	45.72	TLPS-302V-09P	21	106.68	TLPS-302V-21P
Voltage	300V (UL)	10	50.8	TLPS-302V-10P	22	111.76	TLPS-302V-22P
Approval Bodies		11	55.88	TLPS-302V-11P	23	116.84	TLPS-302V-23P
		12	60.96	TLPS-302V-12P	24	121.92	TLPS-302V-24P
		13	66.04	TLPS-302V-13P			

TLPSW-302V-xxP

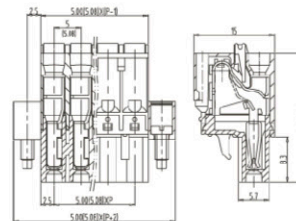

2-24 Pole Cable mount - Female plug Screw Rising clamp Horizontal 5mm pitch

		N° of Poles	Pole Length (mm)	Product Code	N° of Poles	Pole Length (mm)	Product Code
Pitch (mm)	5.08	2	20.32	TLPSW-302V-02P	14	81.28	TLPSW-302V-14P
Wire Size AWG	Min: 24 / Max: 12	3	25.4	TLPSW-302V-03P	15	86.36	TLPSW-302V-15P
Wire Size (mm ²)	Min: 0.2 / Max: 4	4	30.48	TLPSW-302V-04P	16	91.44	TLPSW-302V-16P
PCB Hole Ø		5	35.56	TLPSW-302V-05P	17	96.52	TLPSW-302V-17P
Orientation	Horizontal	6	40.64	TLPSW-302V-06P	18	101.6	TLPSW-302V-18P
Mount Type	Horizontal	7	45.72	TLPSW-302V-07P	19	106.68	TLPSW-302V-19P
Join		8	50.8	TLPSW-302V-08P	20	111.76	TLPSW-302V-20P
Current	16A (UL)	9	55.88	TLPSW-302V-09P	21	116.84	TLPSW-302V-21P
Voltage	300V (UL)	10	60.96	TLPSW-302V-10P	22	121.92	TLPSW-302V-22P
Approval Bodies		11	66.04	TLPSW-302V-11P	23	127	TLPSW-302V-23P
		12	71.12	TLPSW-302V-12P	24	132.08	TLPSW-302V-24P
		13	76.2	TLPSW-302V-13P			

PCB TERMINAL BLOCKS CABLE MOUNTING - PLUGGABLE (FEMALE)

TLPS-300R-xxP

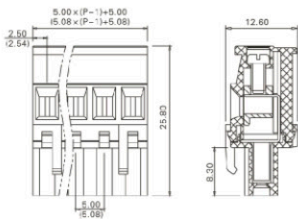

2-24 Pole Cable mount - Female plug Screw
Rising clamp Horizontal 5.08mm pitch

		N° of Poles	Pole Length (mm)	Product Code	N° of Poles	Pole Length (mm)	Product Code
Pitch (mm)	5.08	2	10.16	TLPS-300R-02P	14	71.12	TLPS-300R-14P
Wire Size AWG	Min: 30 / Max: 12	3	15.24	TLPS-300R-03P	15	76.2	TLPS-300R-15P
Wire Size (mm²)	Max: 4	4	20.32	TLPS-300R-04P	16	81.28	TLPS-300R-16P
PCB Hole Ø		5	25.4	TLPS-300R-05P	17	86.36	TLPS-300R-17P
Orientation	Horizontal	6	30.48	TLPS-300R-06P	18	91.44	TLPS-300R-18P
Mount Type	Rising Clamp	7	35.56	TLPS-300R-07P	19	96.52	TLPS-300R-19P
Join		8	40.64	TLPS-300R-08P	20	101.6	TLPS-300R-20P
Current	16A (UL)	9	45.72	TLPS-300R-09P	21	106.68	TLPS-300R-21P
Voltage	300V (UL)	10	50.8	TLPS-300R-10P	22	111.76	TLPS-300R-22P
Approval Bodies	CE UL	11	55.88	TLPS-300R-11P	23	116.84	TLPS-300R-23P
		12	60.96	TLPS-300R-12P	24	121.92	TLPS-300R-24P
		13	66.04	TLPS-300R-13P			

TLPS-300RL-xxP

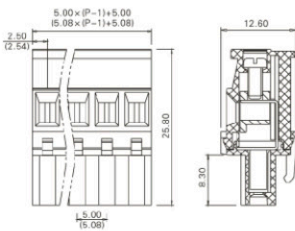

2-24 Pole Cable mount - Female plug Screw
Rising clamp Horizontal 5.08mm pitch

		N° of Poles	Pole Length (mm)	Product Code	N° of Poles	Pole Length (mm)	Product Code
Pitch (mm)	5.08	2	10.16	TLPS-300RL-02P	14	71.12	TLPS-300RL-14P
Wire Size AWG	Min: 30 / Max: 12	3	15.24	TLPS-300RL-03P	15	76.2	TLPS-300RL-15P
Wire Size (mm²)	Max: 4	4	20.32	TLPS-300RL-04P	16	81.28	TLPS-300RL-16P
PCB Hole Ø		5	25.4	TLPS-300RL-05P	17	86.36	TLPS-300RL-17P
Orientation	Horizontal	6	30.48	TLPS-300RL-06P	18	91.44	TLPS-300RL-18P
Mount Type	Rising Clamp	7	35.56	TLPS-300RL-07P	19	96.52	TLPS-300RL-19P
Join		8	40.64	TLPS-300RL-08P	20	101.6	TLPS-300RL-20P
Current	16A (UL)	9	45.72	TLPS-300RL-09P	21	106.68	TLPS-300RL-21P
Voltage	300V (UL)	10	50.8	TLPS-300RL-10P	22	111.76	TLPS-300RL-22P
Approval Bodies	CE UL	11	55.88	TLPS-300RL-11P	23	116.84	TLPS-300RL-23P
		12	60.96	TLPS-300RL-12P	24	121.92	TLPS-300RL-24P
		13	66.04	TLPS-300RL-13P			

TLPSW-300R-xxP

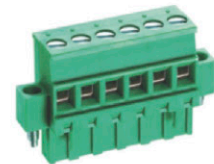
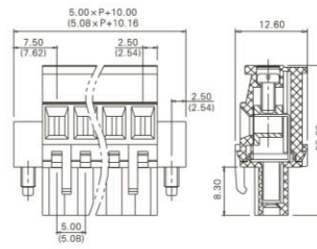

2-24 Pole Cable mount - Female plug Screw
Rising clamp Horizontal 5.08mm pitch

		N° of Poles	Pole Length (mm)	Product Code	N° of Poles	Pole Length (mm)	Product Code
Pitch (mm)	5.08	2	20.32	TLPSW-300R-02P	14	81.28	TLPSW-300R-14P
Wire Size AWG	Min: 30 / Max: 12	3	25.4	TLPSW-300R-03P	15	86.36	TLPSW-300R-15P
Wire Size (mm²)	Max: 4	4	30.48	TLPSW-300R-04P	16	91.44	TLPSW-300R-16P
PCB Hole Ø		5	35.56	TLPSW-300R-05P	17	96.52	TLPSW-300R-17P
Orientation	Horizontal	6	40.64	TLPSW-300R-06P	18	101.6	TLPSW-300R-18P
Mount Type	Rising Clamp	7	45.72	TLPSW-300R-07P	19	106.68	TLPSW-300R-19P
Join		8	50.8	TLPSW-300R-08P	20	111.76	TLPSW-300R-20P
Current	16A (UL)	9	55.88	TLPSW-300R-09P	21	116.84	TLPSW-300R-21P
Voltage	300V (UL)	10	60.96	TLPSW-300R-10P	22	121.92	TLPSW-300R-22P
Approval Bodies	CE UL	11	66.04	TLPSW-300R-11P	23	127	TLPSW-300R-23P
		12	71.12	TLPSW-300R-12P	24	132.08	TLPSW-300R-24P
		13	76.2	TLPSW-300R-13P			

TLPSW-300RL-xxP

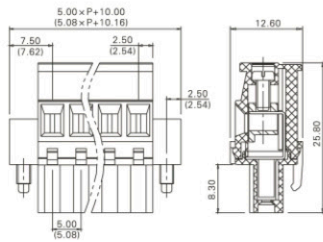

2-24 Pole Cable mount - Female plug Screw
Rising clamp Horizontal 5.08mm pitch

		N° of Poles	Pole Length (mm)	Product Code	N° of Poles	Pole Length (mm)	Product Code
Pitch (mm)	5.08	2	20.32	TLPSW-300RL-02P	14	81.28	TLPSW-300RL-14P
Wire Size AWG	Min: 30 / Max: 12	3	25.4	TLPSW-300RL-03P	15	86.36	TLPSW-300RL-15P
Wire Size (mm²)	Max: 4	4	30.48	TLPSW-300RL-04P	16	91.44	TLPSW-300RL-16P
PCB Hole Ø		5	35.56	TLPSW-300RL-05P	17	96.52	TLPSW-300RL-17P
Orientation	Horizontal	6	40.64	TLPSW-300RL-06P	18	101.6	TLPSW-300RL-18P
Mount Type	Rising Clamp	7	45.72	TLPSW-300RL-07P	19	106.68	TLPSW-300RL-19P
Join		8	50.8	TLPSW-300RL-08P	20	111.76	TLPSW-300RL-20P
Current	16A (UL)	9	55.88	TLPSW-300RL-09P	21	116.84	TLPSW-300RL-21P
Voltage	300V (UL)	10	60.96	TLPSW-300RL-10P	22	121.92	TLPSW-300RL-22P
Approval Bodies	CE UL	11	66.04	TLPSW-300RL-11P	23	127	TLPSW-300RL-23P
		12	71.12	TLPSW-300RL-12P	24	132.08	TLPSW-300RL-24P
		13	76.2	TLPSW-300RL-13P			

TLPS-300V-xxP

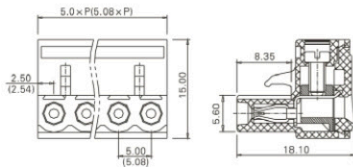

2-24 Pole Cable mount - Female plug Screw
Rising clamp Vertical 5.08mm pitch

		N° of Poles	Pole Length (mm)	Product Code	N° of Poles	Pole Length (mm)	Product Code
Pitch (mm)	5.08	2	10.16	TLPS-300V-02P	14	71.12	TLPS-300V-14P
Wire Size AWG	Min: 28 / Max: 14	3	15.24	TLPS-300V-03P	15	76.2	TLPS-300V-15P
Wire Size (mm²)	Min: 0.75 / Max: 2.5	4	20.32	TLPS-300V-04P	16	81.28	TLPS-300V-16P
PCB Hole Ø		5	25.4	TLPS-300V-05P	17	86.36	TLPS-300V-17P
Orientation	Vertical	6	30.48	TLPS-300V-06P	18	91.44	TLPS-300V-18P
Mount Type	Rising Clamp	7	35.56	TLPS-300V-07P	19	96.52	TLPS-300V-19P
Join		8	40.64	TLPS-300V-08P	20	101.6	TLPS-300V-20P
Current	16A (UL) / 15A (VDE)	9	45.72	TLPS-300V-09P	21	106.68	TLPS-300V-21P
Voltage	300V (UL) / 250V (VDE)	10	50.8	TLPS-300V-10P	22	111.76	TLPS-300V-22P
Approval Bodies	CE UL CSA cULus	11	55.88	TLPS-300V-11P	23	116.84	TLPS-300V-23P
		12	60.96	TLPS-300V-12P	24	121.92	TLPS-300V-24P
		13	66.04	TLPS-300V-13P			

TLPS-301V-xxP

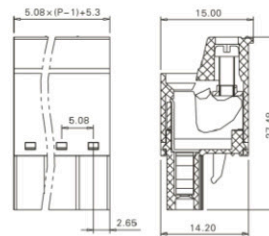

2-24 Pole Cable mount - Female plug Screw
Rising clamp Vertical 5.08mm pitch

		N° of Poles	Pole Length (mm)	Product Code	N° of Poles	Pole Length (mm)	Product Code
Pitch (mm)	5.08	2	10.38	TLPS-301V-02P	14	71.34	TLPS-301V-14P
Wire Size AWG	Min: 30 / Max: 12	3	15.46	TLPS-301V-03P	15	76.42	TLPS-301V-15P
Wire Size (mm²)	Max: 4	4	20.54	TLPS-301V-04P	16	81.5	TLPS-301V-16P
PCB Hole Ø		5	25.62	TLPS-301V-05P	17	86.58	TLPS-301V-17P
Orientation	Vertical	6	30.7	TLPS-301V-06P	18	91.66	TLPS-301V-18P
Mount Type	Rising Clamp	7	35.78	TLPS-301V-07P	19	96.74	TLPS-301V-19P
Join		8	40.86	TLPS-301V-08P	20	101.82	TLPS-301V-20P
Current	16A (UL)	9	45.94	TLPS-301V-09P	21	106.9	TLPS-301V-21P
Voltage	300V (UL)	10	51.02	TLPS-301V-10P	22	111.98	TLPS-301V-22P
Approval Bodies	CE UL	11	56.1	TLPS-301V-11P	23	117.06	TLPS-301V-23P
		12	61.18	TLPS-301V-12P	24	122.14	TLPS-301V-24P
		13	66.26	TLPS-301V-13P			

*xx = number of poles

PCB TERMINAL BLOCKS CABLE MOUNTING - PLUGGABLE (FEMALE)

TLPSW-300V-xxP

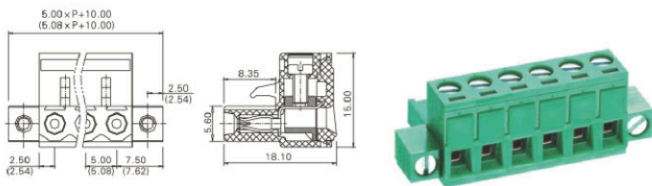

2-24 Pole Cable mount - Female plug Screw
Rising clamp Vertical 5.08mm pitch

		N° of Poles	Pole Length (mm)	Product Code	N° of Poles	Pole Length (mm)	Product Code
Pitch (mm)	5.08	2	20.16	TLPSW-300V-02P	14	81.12	TLPSW-300V-14P
Wire Size AWG	Min: 28 / Max: 14	3	25.24	TLPSW-300V-03P	15	86.2	TLPSW-300V-15P
Wire Size (mm ²)	Min: 0.75 / Max: 2.5	4	30.32	TLPSW-300V-04P	16	91.28	TLPSW-300V-16P
PCB Hole Ø		5	35.4	TLPSW-300V-05P	17	96.36	TLPSW-300V-17P
Orientation	Vertical	6	40.48	TLPSW-300V-06P	18	101.44	TLPSW-300V-18P
Mount Type	Rising Clamp	7	45.56	TLPSW-300V-07P	19	106.52	TLPSW-300V-19P
Join		8	50.64	TLPSW-300V-08P	20	111.6	TLPSW-300V-20P
Current	16A (UL) / 15A (VDE)	9	55.72	TLPSW-300V-09P	21	116.68	TLPSW-300V-21P
Voltage	300V (UL) / 250V (VDE)	10	60.8	TLPSW-300V-10P	22	121.76	TLPSW-300V-22P
Approval Bodies		11	65.88	TLPSW-300V-11P	23	126.84	TLPSW-300V-23P
		12	70.96	TLPSW-300V-12P	24	131.92	TLPSW-300V-24P
		13	76.04	TLPSW-300V-13P			

TLPSW-301V-xxP

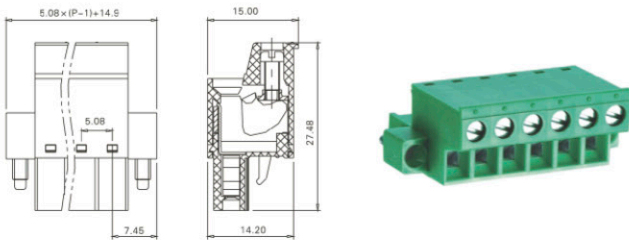

22-24 Pole Cable mount - Female plug
Screw Rising clamp Vertical 5.08mm pitch

		N° of Poles	Pole Length (mm)	Product Code	N° of Poles	Pole Length (mm)	Product Code
Pitch (mm)	5.08	2	19.98	TLPSW-301V-02P	14	80.94	TLPSW-301V-14P
Wire Size AWG	Min: 30 / Max: 12	3	25.06	TLPSW-301V-03P	15	86.02	TLPSW-301V-15P
Wire Size (mm ²)	Max: 4	4	30.14	TLPSW-301V-04P	16	91.1	TLPSW-301V-16P
PCB Hole Ø		5	35.22	TLPSW-301V-05P	17	96.18	TLPSW-301V-17P
Orientation	Vertical	6	40.3	TLPSW-301V-06P	18	101.26	TLPSW-301V-18P
Mount Type	Rising Clamp	7	45.38	TLPSW-301V-07P	19	106.34	TLPSW-301V-19P
Join		8	50.46	TLPSW-301V-08P	20	111.42	TLPSW-301V-20P
Current	16A (UL)	9	55.54	TLPSW-301V-09P	21	116.5	TLPSW-301V-21P
Voltage	300V (UL)	10	60.62	TLPSW-301V-10P	22	121.58	TLPSW-301V-22P
Approval Bodies		11	65.7	TLPSW-301V-11P	23	126.66	TLPSW-301V-23P
		12	70.78	TLPSW-301V-12P	24	131.74	TLPSW-301V-24P
		13	75.86	TLPSW-301V-13P			

TLPS-400V-xxP

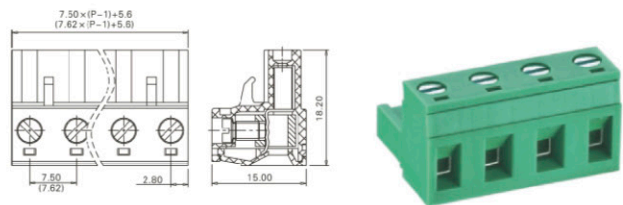

2-24 Pole Cable mount - Female plug Screw
Rising clamp Vertical 7.5mm pitch

		N° of Poles	Pole Length (mm)	Product Code	N° of Poles	Pole Length (mm)	Product Code
Pitch (mm)	7.5	2	13.1	TLPS-400V-02P	14	103.1	TLPS-400V-14P
Wire Size AWG	Min: 30 / Max: 12	3	20.6	TLPS-400V-03P	15	110.6	TLPS-400V-15P
Wire Size (mm ²)	Max: 4	4	28.1	TLPS-400V-04P	16	118.1	TLPS-400V-16P
PCB Hole Ø		5	35.6	TLPS-400V-05P	17	125.6	TLPS-400V-17P
Orientation	Vertical	6	43.1	TLPS-400V-06P	18	133.1	TLPS-400V-18P
Mount Type	Rising Clamp	7	50.6	TLPS-400V-07P	19	140.6	TLPS-400V-19P
Join		8	58.1	TLPS-400V-08P	20	148.1	TLPS-400V-20P
Current	16A (UL) / 15A (VDE)	9	65.6	TLPS-400V-09P	21	155.6	TLPS-400V-21P
Voltage	300V (UL) / 450V (VDE)	10	73.1	TLPS-400V-10P	22	163.1	TLPS-400V-22P
Approval Bodies		11	80.6	TLPS-400V-11P	23	170.6	TLPS-400V-23P
		12	88.1	TLPS-400V-12P	24	178.1	TLPS-400V-24P
		13	95.6	TLPS-400V-13P			

*xx = number of poles

TLPSW-400V-xxP

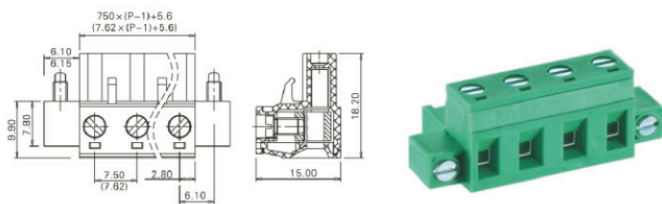

2-24 Pole Cable mount - Female plug Screw
Rising clamp Vertical 7.5mm pitch

		N° of Poles	Pole Length (mm)	Product Code	N° of Poles	Pole Length (mm)	Product Code
Pitch (mm)	7.5	2	25.3	TLPSW-400V-02P	14	115.3	TLPSW-400V-14P
Wire Size AWG	Min: 30 / Max: 12	3	32.8	TLPSW-400V-03P	15	122.8	TLPSW-400V-15P
Wire Size (mm ²)	Max: 4	4	40.3	TLPSW-400V-04P	16	130.3	TLPSW-400V-16P
PCB Hole Ø		5	47.8	TLPSW-400V-05P	17	137.8	TLPSW-400V-17P
Orientation	Vertical	6	55.3	TLPSW-400V-06P	18	145.3	TLPSW-400V-18P
Mount Type	Rising Clamp	7	62.8	TLPSW-400V-07P	19	152.8	TLPSW-400V-19P
Join		8	70.3	TLPSW-400V-08P	20	160.3	TLPSW-400V-20P
Current	16A (UL) / 15A (VDE)	9	77.8	TLPSW-400V-09P	21	167.8	TLPSW-400V-21P
Voltage	300V (UL) / 450V (VDE)	10	85.3	TLPSW-400V-10P	22	175.3	TLPSW-400V-22P
Approval Bodies	CE UL	11	92.8	TLPSW-400V-11P	23	182.8	TLPSW-400V-23P
		12	100.3	TLPSW-400V-12P	24	190.3	TLPSW-400V-24P
		13	107.8	TLPSW-400V-13P			

TLPS-400R-xxP

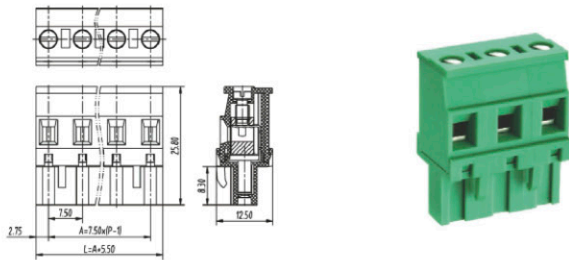

2-24 Pole Pluggable type Vertical 7.5mm pitch

		N° of Poles	Pole Length (mm)	Product Code	N° of Poles	Pole Length (mm)	Product Code
Pitch (mm)	7.5	2	13	TLPS-400R-02P	14	103	TLPS-400R-14P
Wire Size AWG	Min: 30 / Max: 12	3	20.5	TLPS-400R-03P	15	110.5	TLPS-400R-15P
Wire Size (mm ²)	Max: 4	4	28	TLPS-400R-04P	16	118	TLPS-400R-16P
PCB Hole Ø		5	35.5	TLPS-400R-05P	17	125.5	TLPS-400R-17P
Orientation	Vertical	6	43	TLPS-400R-06P	18	133	TLPS-400R-18P
Mount Type	Vertical	7	50.5	TLPS-400R-07P	19	140.5	TLPS-400R-19P
Join		8	58	TLPS-400R-08P	20	148	TLPS-400R-20P
Current	16A (UL)	9	65.5	TLPS-400R-09P	21	155.5	TLPS-400R-21P
Voltage	300V (UL)	10	73	TLPS-400R-10P	22	163	TLPS-400R-22P
Approval Bodies	UL	11	80.5	TLPS-400R-11P	23	170.5	TLPS-400R-23P
		12	88	TLPS-400R-12P	24	178	TLPS-400R-24P
		13	95.5	TLPS-400R-13P			

TLPS-400RL-xxP

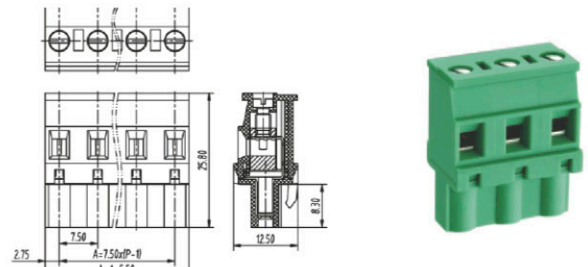

2-24 Pole Pluggable type Vertical 7.5mm pitch

		N° of Poles	Pole Length (mm)	Product Code	N° of Poles	Pole Length (mm)	Product Code
Pitch (mm)	7.5	2	13	TLPS-400RL-02P	14	103	TLPS-400RL-14P
Wire Size AWG	Min: 26 / Max: 12	3	20.5	TLPS-400RL-03P	15	110.5	TLPS-400RL-15P
Wire Size (mm ²)	Min: 0.2 / Max: 4	4	28	TLPS-400RL-04P	16	118	TLPS-400RL-16P
PCB Hole Ø		5	35.5	TLPS-400RL-05P	17	125.5	TLPS-400RL-17P
Orientation	Vertical	6	43	TLPS-400RL-06P	18	133	TLPS-400RL-18P
Mount Type	Vertical	7	50.5	TLPS-400RL-07P	19	140.5	TLPS-400RL-19P
Join		8	58	TLPS-400RL-08P	20	148	TLPS-400RL-20P
Current	16A (UL)	9	65.5	TLPS-400RL-09P	21	155.5	TLPS-400RL-21P
Voltage	300V (UL)	10	73	TLPS-400RL-10P	22	163	TLPS-400RL-22P
Approval Bodies	UL	11	80.5	TLPS-400RL-11P	23	170.5	TLPS-400RL-23P
		12	88	TLPS-400RL-12P	24	178	TLPS-400RL-24P
		13	95.5	TLPS-400RL-13P			

*xx = number of poles

PCB TERMINAL BLOCKS CABLE MOUNTING - PLUGGABLE (FEMALE)

TLPSW-400R-xxP

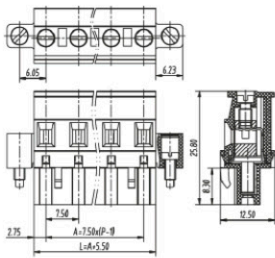

2-24 Pole Pluggable type Vertical 7.5mm pitch

		N° of Poles	Pole Length (mm)	Product Code	N° of Poles	Pole Length (mm)	Product Code
Pitch (mm)	7.5	2	25.46	TLPSW-400R-02P	14	115.46	TLPSW-400R-14P
Wire Size AWG	Min: 26 / Max: 12	3	32.96	TLPSW-400R-03P	15	122.96	TLPSW-400R-15P
Wire Size (mm²)	Min: 0.2 / Max: 4	4	40.46	TLPSW-400R-04P	16	130.46	TLPSW-400R-16P
PCB Hole Ø		5	47.96	TLPSW-400R-05P	17	137.96	TLPSW-400R-17P
Orientation	Vertical	6	55.46	TLPSW-400R-06P	18	145.46	TLPSW-400R-18P
Mount Type	Vertical	7	62.96	TLPSW-400R-07P	19	152.96	TLPSW-400R-19P
Join		8	70.46	TLPSW-400R-08P	20	160.46	TLPSW-400R-20P
Current	16A (UL)	9	77.96	TLPSW-400R-09P	21	167.96	TLPSW-400R-21P
Voltage	300V (UL)	10	85.46	TLPSW-400R-10P	22	175.46	TLPSW-400R-22P
Approval Bodies	UL	11	92.96	TLPSW-400R-11P	23	182.96	TLPSW-400R-23P
		12	100.46	TLPSW-400R-12P	24	190.46	TLPSW-400R-24P
		13	107.96	TLPSW-400R-13P			

TLPSW-400RL-xxP

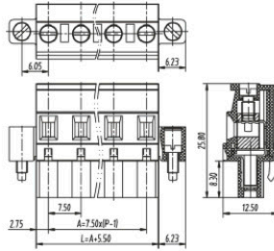

2-24 Pole Pluggable type Vertical 7.5mm pitch

		N° of Poles	Pole Length (mm)	Product Code	N° of Poles	Pole Length (mm)	Product Code
Pitch (mm)	7.5	2	25.46	TLPSW-400RL-02P	14	115.46	TLPSW-400RL-14P
Wire Size AWG	Min: 26 / Max: 12	3	32.96	TLPSW-400RL-03P	15	122.96	TLPSW-400RL-15P
Wire Size (mm²)	Min: 0.2 / Max: 4	4	40.46	TLPSW-400RL-04P	16	130.46	TLPSW-400RL-16P
PCB Hole Ø		5	47.96	TLPSW-400RL-05P	17	137.96	TLPSW-400RL-17P
Orientation	Vertical	6	55.46	TLPSW-400RL-06P	18	145.46	TLPSW-400RL-18P
Mount Type	Vertical	7	62.96	TLPSW-400RL-07P	19	152.96	TLPSW-400RL-19P
Join		8	70.46	TLPSW-400RL-08P	20	160.46	TLPSW-400RL-20P
Current	16A (UL)	9	77.96	TLPSW-400RL-09P	21	167.96	TLPSW-400RL-21P
Voltage	300V (UL)	10	85.46	TLPSW-400RL-10P	22	175.46	TLPSW-400RL-22P
Approval Bodies	UL	11	92.96	TLPSW-400RL-11P	23	182.96	TLPSW-400RL-23P
		12	100.46	TLPSW-400RL-12P	24	190.46	TLPSW-400RL-24P
		13	107.96	TLPSW-400RL-13P			

TLPS-500V-xxP

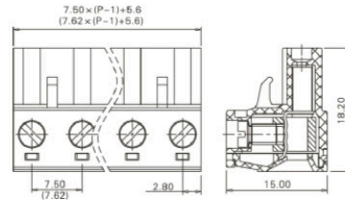

2-24 Pole Cable mount - Female plug Screw Rising clamp Vertical 7.62mm pitch

		N° of Poles	Pole Length (mm)	Product Code	N° of Poles	Pole Length (mm)	Product Code
Pitch (mm)	7.62	2	13.22	TLPS-500V-02P	14	104.66	TLPS-500V-14P
Wire Size AWG	Min: 30 / Max: 12	3	20.84	TLPS-500V-03P	15	112.28	TLPS-500V-15P
Wire Size (mm²)	Max: 4	4	28.46	TLPS-500V-04P	16	119.9	TLPS-500V-16P
PCB Hole Ø		5	36.08	TLPS-500V-05P	17	127.52	TLPS-500V-17P
Orientation	Vertical	6	43.7	TLPS-500V-06P	18	135.14	TLPS-500V-18P
Mount Type	Rising Clamp	7	51.32	TLPS-500V-07P	19	142.76	TLPS-500V-19P
Join		8	58.94	TLPS-500V-08P	20	150.38	TLPS-500V-20P
Current	16A (UL) / 15A (VDE)	9	66.56	TLPS-500V-09P	21	158	TLPS-500V-21P
Voltage	300V (UL) / 450V (VDE)	10	74.18	TLPS-500V-10P	22	165.62	TLPS-500V-22P
Approval Bodies	CE, UL, VDE	11	81.8	TLPS-500V-11P	23	173.24	TLPS-500V-23P
		12	89.42	TLPS-500V-12P	24	180.86	TLPS-500V-24P
		13	97.04	TLPS-500V-13P			

TLPSW-500V-xxP

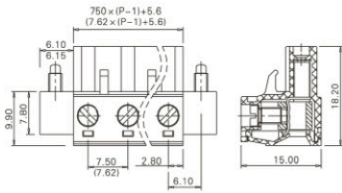

2-24 Pole Cable mount - Female plug Screw
Rising clamp Vertical 7.62mm pitch

		N° of Poles	Pole Length (mm)	Product Code	N° of Poles	Pole Length (mm)	Product Code
Pitch (mm)	7.62	2	25.42	TLPSW-500V-02P	14	116.86	TLPSW-500V-14P
Wire Size AWG	Min: 26 / Max: 12	3	33.04	TLPSW-500V-03P	15	124.48	TLPSW-500V-15P
Wire Size (mm²)	Min: 0.2 / Max: 4	4	40.66	TLPSW-500V-04P	16	132.1	TLPSW-500V-16P
PCB Hole Ø		5	48.28	TLPSW-500V-05P	17	139.72	TLPSW-500V-17P
Orientation	Vertical	6	55.9	TLPSW-500V-06P	18	147.34	TLPSW-500V-18P
Mount Type	Rising Clamp	7	63.52	TLPSW-500V-07P	19	154.96	TLPSW-500V-19P
Join		8	71.14	TLPSW-500V-08P	20	162.58	TLPSW-500V-20P
Current	16A (UL) / 15A (VDE)	9	78.76	TLPSW-500V-09P	21	170.2	TLPSW-500V-21P
Voltage	300V (UL) / 450V (VDE)	10	86.38	TLPSW-500V-10P	22	177.82	TLPSW-500V-22P
Approval Bodies	CE UL	11	94	TLPSW-500V-11P	23	185.44	TLPSW-500V-23P
		12	101.62	TLPSW-500V-12P	24	193.06	TLPSW-500V-24P
		13	109.24	TLPSW-500V-13P			

TLPS-500R-xxP

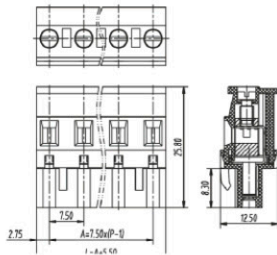

2-24 Pole Pluggable type Vertical 7.62mm pitch

		N° of Poles	Pole Length (mm)	Product Code	N° of Poles	Pole Length (mm)	Product Code
Pitch (mm)	7.62	2	13.22	TLPS-500R-02P	14	104.66	TLPS-500R-14P
Wire Size AWG	Min: 26 / Max: 12	3	20.84	TLPS-500R-03P	15	112.28	TLPS-500R-15P
Wire Size (mm²)	Min: 0.2 / Max: 4	4	28.46	TLPS-500R-04P	16	119.9	TLPS-500R-16P
PCB Hole Ø		5	36.08	TLPS-500R-05P	17	127.52	TLPS-500R-17P
Orientation	Vertical	6	43.7	TLPS-500R-06P	18	135.14	TLPS-500R-18P
Mount Type	Vertical	7	51.32	TLPS-500R-07P	19	142.76	TLPS-500R-19P
Join		8	58.94	TLPS-500R-08P	20	150.38	TLPS-500R-20P
Current	16A (UL)	9	66.56	TLPS-500R-09P	21	158	TLPS-500R-21P
Voltage	300V (UL)	10	74.18	TLPS-500R-10P	22	165.62	TLPS-500R-22P
Approval Bodies	UL	11	81.8	TLPS-500R-11P	23	173.24	TLPS-500R-23P
		12	89.42	TLPS-500R-12P	24	180.86	TLPS-500R-24P
		13	97.04	TLPS-500R-13P			

TLPS-500RL-xxP

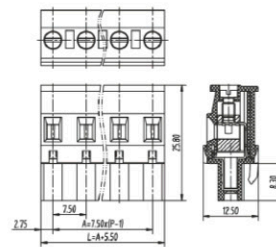

2-24 Pole Pluggable type Vertical 7.62mm pitch

		N° of Poles	Pole Length (mm)	Product Code	N° of Poles	Pole Length (mm)	Product Code
Pitch (mm)	7.62	2	13.22	TLPS-500RL-02P	14	104.66	TLPS-500RL-14P
Wire Size AWG	Min: 26 / Max: 12	3	20.84	TLPS-500RL-03P	15	112.28	TLPS-500RL-15P
Wire Size (mm²)	Min: 0.2 / Max: 4	4	28.46	TLPS-500RL-04P	16	119.9	TLPS-500RL-16P
PCB Hole Ø		5	36.08	TLPS-500RL-05P	17	127.52	TLPS-500RL-17P
Orientation	Vertical	6	43.7	TLPS-500RL-06P	18	135.14	TLPS-500RL-18P
Mount Type	Vertical	7	51.32	TLPS-500RL-07P	19	142.76	TLPS-500RL-19P
Join		8	58.94	TLPS-500RL-08P	20	150.38	TLPS-500RL-20P
Current	16A (UL)	9	66.56	TLPS-500RL-09P	21	158	TLPS-500RL-21P
Voltage	300V (UL)	10	74.18	TLPS-500RL-10P	22	165.62	TLPS-500RL-22P
Approval Bodies	UL	11	81.8	TLPS-500RL-11P	23	173.24	TLPS-500RL-23P
		12	89.42	TLPS-500RL-12P	24	180.86	TLPS-500RL-24P
		13	97.04	TLPS-500RL-13P			

*xx = number of poles

PCB TERMINAL BLOCKS CABLE MOUNTING - PLUGGABLE (FEMALE)

TLPSW-500R-xxP

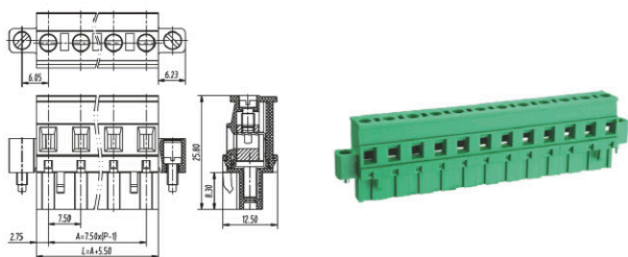

2-24 Pole Pluggable type Vertical 7.62mm pitch

		N° of Poles	Pole Length (mm)	Product Code	N° of Poles	Pole Length (mm)	Product Code
Pitch (mm)	7.62	2	25.58	TLPSW-500R-02P	14	117.02	TLPSW-500R-14P
Wire Size AWG	Min: 26 / Max: 12	3	33.2	TLPSW-500R-03P	15	124.64	TLPSW-500R-15P
Wire Size (mm²)	Min: 0.2 / Max: 4	4	40.82	TLPSW-500R-04P	16	132.26	TLPSW-500R-16P
PCB Hole Ø		5	48.44	TLPSW-500R-05P	17	139.88	TLPSW-500R-17P
Orientation	Vertical	6	56.06	TLPSW-500R-06P	18	147.5	TLPSW-500R-18P
Mount Type	Vertical	7	63.68	TLPSW-500R-07P	19	155.12	TLPSW-500R-19P
Join		8	71.3	TLPSW-500R-08P	20	162.74	TLPSW-500R-20P
Current	16A (UL)	9	78.92	TLPSW-500R-09P	21	170.36	TLPSW-500R-21P
Voltage	300V (UL)	10	86.54	TLPSW-500R-10P	22	177.98	TLPSW-500R-22P
Approval Bodies	UL	11	94.16	TLPSW-500R-11P	23	185.6	TLPSW-500R-23P
		12	101.78	TLPSW-500R-12P	24	193.22	TLPSW-500R-24P
		13	109.4	TLPSW-500R-13P			

TLPSW-500RL-xxP

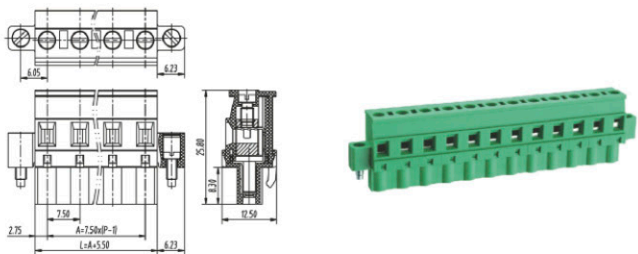

2-24 Pole Pluggable type Vertical 7.62mm pitch

		N° of Poles	Pole Length (mm)	Product Code	N° of Poles	Pole Length (mm)	Product Code
Pitch (mm)	7.62	2	25.58	TLPSW-500RL-02P	14	117.02	TLPSW-500RL-14P
Wire Size AWG	Min: 26 / Max: 12	3	33.2	TLPSW-500RL-03P	15	124.64	TLPSW-500RL-15P
Wire Size (mm²)	Min: 0.2 / Max: 4	4	40.82	TLPSW-500RL-04P	16	132.26	TLPSW-500RL-16P
PCB Hole Ø		5	48.44	TLPSW-500RL-05P	17	139.88	TLPSW-500RL-17P
Orientation	Vertical	6	56.06	TLPSW-500RL-06P	18	147.5	TLPSW-500RL-18P
Mount Type	Vertical	7	63.68	TLPSW-500RL-07P	19	155.12	TLPSW-500RL-19P
Join		8	71.3	TLPSW-500RL-08P	20	162.74	TLPSW-500RL-20P
Current	16A (UL)	9	78.92	TLPSW-500RL-09P	21	170.36	TLPSW-500RL-21P
Voltage	300V (UL)	10	86.54	TLPSW-500RL-10P	22	177.98	TLPSW-500RL-22P
Approval Bodies	UL	11	94.16	TLPSW-500RL-11P	23	185.6	TLPSW-500RL-23P
		12	101.78	TLPSW-500RL-12P	24	193.22	TLPSW-500RL-24P
		13	109.4	TLPSW-500RL-13P			

TLPS-200R-xxP5

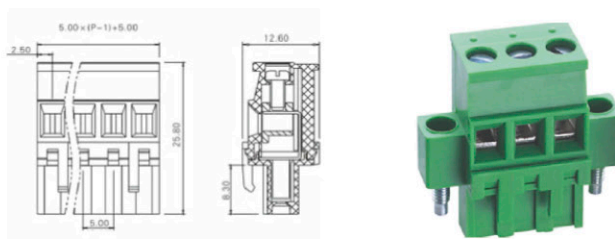

2-8 Pole Cable mount - Female plug Screw Rising clamp Horizontal 10mm pitch

		N° of Poles	Pole Length (mm)	Product Code	N° of Poles	Pole Length (mm)	Product Code
Pitch (mm)	10	2	15	TLPS-200R-02P5			
Wire Size AWG	Min: 30 / Max: 12	3	25	TLPS-200R-03P5			
Wire Size (mm²)	Max: 4	4	35	TLPS-200R-04P5			
PCB Hole Ø		5	45	TLPS-200R-05P5			
Orientation	Horizontal	6	55	TLPS-200R-06P5			
Mount Type	Rising Clamp	7	65	TLPS-200R-07P5			
Join		8	75	TLPS-200R-08P5			
Current	16A (UL)						
Voltage	300V (UL)						
Approval Bodies	CE UL						

TLPS-200RL-xxP5

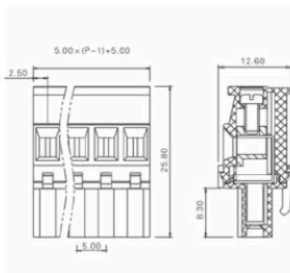

2-8 Pole Cable mount - Female plug Screw
Rising clamp Horizontal 10mm pitch

		N° of Poles	Pole Length (mm)	Product Code	N° of Poles	Pole Length (mm)	Product Code
Pitch (mm)	10	2	15	TLPS-200RL-02P5			
Wire Size AWG	Min: 30 / Max: 12	3	25	TLPS-200RL-03P5			
Wire Size (mm ²)	Max: 4	4	35	TLPS-200RL-04P5			
PCB Hole Ø		5	45	TLPS-200RL-05P5			
Orientation	Horizontal	6	55	TLPS-200RL-06P5			
Mount Type	Rising Clamp	7	65	TLPS-200RL-07P5			
Join		8	75	TLPS-200RL-08P5			
Current	16A (UL)						
Voltage	300V (UL)						
Approval Bodies	CE UL						

TLPSW-200R-xxP5

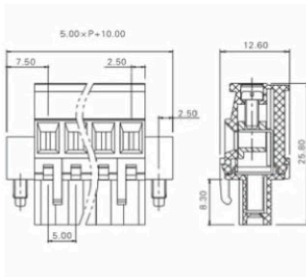

2-8 Pole Cable mount - Female plug Screw
Rising clamp Horizontal 10mm pitch

		N° of Poles	Pole Length (mm)	Product Code	N° of Poles	Pole Length (mm)	Product Code
Pitch (mm)	10	2	30	TLPSW-200R-02P5			
Wire Size AWG	Min: 30 / Max: 12	3	40	TLPSW-200R-03P5			
Wire Size (mm ²)	Max: 4	4	50	TLPSW-200R-04P5			
PCB Hole Ø		5	60	TLPSW-200R-05P5			
Orientation	Horizontal	6	70	TLPSW-200R-06P5			
Mount Type	Rising Clamp	7	80	TLPSW-200R-07P5			
Join		8	90	TLPSW-200R-08P5			
Current	16A (UL)						
Voltage	300V (UL)						
Approval Bodies	CE UL						

TLPSW-200RL-xxP5

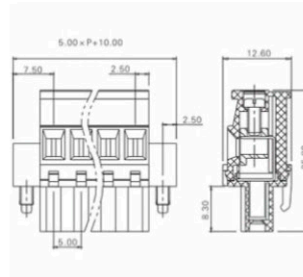

2-8 Pole Cable mount - Female plug Screw
Rising clamp Horizontal 10mm pitch

		N° of Poles	Pole Length (mm)	Product Code	N° of Poles	Pole Length (mm)	Product Code
Pitch (mm)	10	2	25	TLPSW-200RL-02P5			
Wire Size AWG	Min: 30 / Max: 12	3	35	TLPSW-200RL-03P5			
Wire Size (mm ²)	Max: 4	4	45	TLPSW-200RL-04P5			
PCB Hole Ø		5	55	TLPSW-200RL-05P5			
Orientation	Horizontal	6	65	TLPSW-200RL-06P5			
Mount Type	Rising Clamp	7	75	TLPSW-200RL-07P5			
Join		8	85	TLPSW-200RL-08P5			
Current	16A (UL)						
Voltage	300V (UL)						
Approval Bodies	CE UL						

*xx = number of poles

PCB TERMINAL BLOCKS CABLE MOUNTING - PLUGGABLE (FEMALE)

TLPSW-200V-xxP5

2-8 Pole Cable mount - Female plug Screw
Rising clamp Vertical 10mm pitch

		N° of Poles	Pole Length (mm)	Product Code	N° of Poles	Pole Length (mm)	Product Code
Pitch (mm)	10	2	25	TLPSW-200V-02P5			
Wire Size AWG	Min: 28 / Max: 12	3	35	TLPSW-200V-03P5			
Wire Size (mm²)	Min: 0.75 / Max: 2.5	4	45	TLPSW-200V-04P5			
PCB Hole Ø		5	55	TLPSW-200V-05P5			
Orientation	Vertical	6	65	TLPSW-200V-06P5			
Mount Type	Rising Clamp	7	75	TLPSW-200V-07P5			
Join		8	85	TLPSW-200V-08P5			
Current	16A (UL)						
Voltage	300V (UL)						
Approval Bodies							

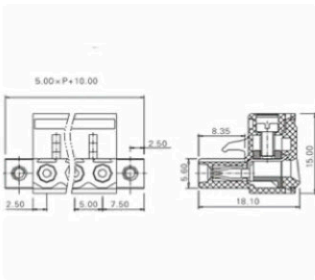

TLPS-200V-xxP5

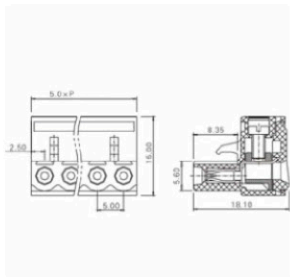

2-8 Pole Cable mount - Female plug Screw
Rising clamp Vertical 10mm pitch

		N° of Poles	Pole Length (mm)	Product Code	N° of Poles	Pole Length (mm)	Product Code
Pitch (mm)	10	2	15	TLPS-200V-02P5			
Wire Size AWG	Min: 28 / Max: 12	3	25	TLPS-200V-03P5			
Wire Size (mm²)	Min: 0.75 / Max: 2.5	4	35	TLPS-200V-04P5			
PCB Hole Ø		5	45	TLPS-200V-05P5			
Orientation	Vertical	6	55	TLPS-200V-06P5			
Mount Type	Rising Clamp	7	65	TLPS-200V-07P5			
Join		8	75	TLPS-200V-08P5			
Current	16A (UL) / 15A (VDE)						
Voltage	300V (UL) / 250V (VDE)						
Approval Bodies							

TLPS-300R-xxP5

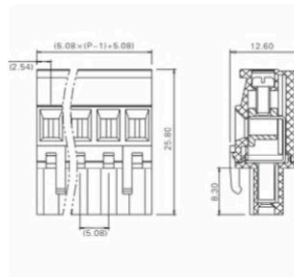

2-8 Pole Cable mount - Female plug Screw
Rising clamp Horizontal 10.16mm pitch

		N° of Poles	Pole Length (mm)	Product Code	N° of Poles	Pole Length (mm)	Product Code
Pitch (mm)	10.16	2	15.24	TLPS-300R-02P5			
Wire Size AWG	Min: 30 / Max: 12	3	25.4	TLPS-300R-03P5			
Wire Size (mm²)	Max: 4	4	35.56	TLPS-300R-04P5			
PCB Hole Ø		5	45.72	TLPS-300R-05P5			
Orientation	Horizontal	6	55.88	TLPS-300R-06P5			
Mount Type	Rising Clamp	7	66.04	TLPS-300R-07P5			
Join		8	76.2	TLPS-300R-08P5			
Current	16A (UL)						
Voltage	300V (UL)						
Approval Bodies							

TLPS-300RL-xxP5

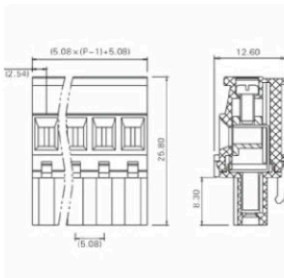

2-8 Pole Cable mount - Female plug Screw
Rising clamp Horizontal 10.16mm pitch

		N° of Poles	Pole Length (mm)	Product Code	N° of Poles	Pole Length (mm)	Product Code
Pitch (mm)	10.16	2	15.24	TLPS-300RL-02P5			
Wire Size AWG	Min: 30 / Max: 12	3	25.4	TLPS-300RL-03P5			
Wire Size (mm²)	Max: 4	4	35.56	TLPS-300RL-04P5			
PCB Hole Ø		5	45.72	TLPS-300RL-05P5			
Orientation	Horizontal	6	55.88	TLPS-300RL-06P5			
Mount Type	Rising Clamp	7	66.04	TLPS-300RL-07P5			
Join		8	76.2	TLPS-300RL-08P5			
Current	16A (UL)						
Voltage	300V (UL)						
Approval Bodies	CE UL						

TLPSW-300R-xxP5

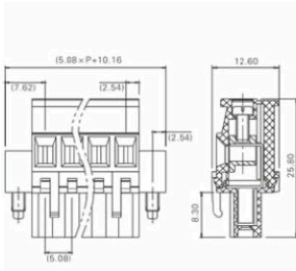

2-8 Pole Cable mount - Female plug Screw
Rising clamp Horizontal 10.16mm pitch

		N° of Poles	Pole Length (mm)	Product Code	N° of Poles	Pole Length (mm)	Product Code
Pitch (mm)	10.16	2	25.4	TLPSW-300R-02P5			
Wire Size AWG	Min: 30 / Max: 12	3	35.56	TLPSW-300R-03P5			
Wire Size (mm²)	Max: 4	4	45.72	TLPSW-300R-04P5			
PCB Hole Ø		5	55.88	TLPSW-300R-05P5			
Orientation	Horizontal	6	66.04	TLPSW-300R-06P5			
Mount Type	Rising Clamp	7	76.2	TLPSW-300R-07P5			
Join		8	86.36	TLPSW-300R-08P5			
Current	16A (UL)						
Voltage	300V (UL)						
Approval Bodies	CE UL						

TLPSW-300RL-xxP5

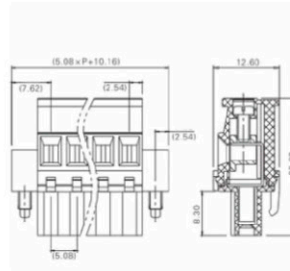

2-8 Pole Cable mount - Female plug Screw
Rising clamp Horizontal 10.16mm pitch

		N° of Poles	Pole Length (mm)	Product Code	N° of Poles	Pole Length (mm)	Product Code
Pitch (mm)	10.16	2	25.4	TLPSW-300RL-02P5			
Wire Size AWG	Min: 30 / Max: 12	3	35.56	TLPSW-300RL-03P5			
Wire Size (mm²)	Max: 4	4	45.72	TLPSW-300RL-04P5			
PCB Hole Ø		5	55.88	TLPSW-300RL-05P5			
Orientation	Horizontal	6	66.04	TLPSW-300RL-06P5			
Mount Type	Rising Clamp	7	76.2	TLPSW-300RL-07P5			
Join		8	86.36	TLPSW-300RL-08P5			
Current	16A (UL)						
Voltage	300V (UL)						
Approval Bodies	CE UL						

*xx = number of poles

PCB FUSE HOLDERS CYLINDRICAL & SEMI ENCLOSED

CYLINDRICAL FUSE HOLDERS

Features:

- Horizontal and vertical mounting options available
- Bayonet carrier with finger or screwdriver release
- Anti Solder Wicking
- Manufactured in accordance with IEC 127-6 & UL512
- Finger or screwdriver release, bayonet carrier
- Compact footprint 10mm pitch
- UL, VDE approved

DFH06N

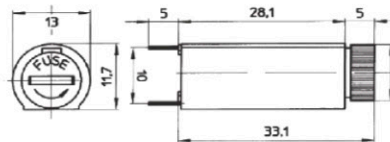

DFH07N

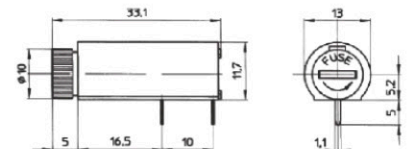

Product Code	Rating	Contacts Material	Contact Resistance	Orientation	Body Material	Dielectric Strength	Power Dissipation	PCB hole size	Insulation Resistance	Approvals
DFH06N	10A / 250V	Tinned Nickel Plated Brass	<5mΩ	Vertical	UL94 V0 Flame Retardant PBT	3KV/60°	2.5W	1.5mm	100MΩ	Applied for, pending confirmation
DFH07N	10A / 250V	Tinned Nickel Plated Brass	<5mΩ	Horizontal	UL94 V0 Flame Retardant PBT	3KV/60°	2.5W	1.5mm	100MΩ	Applied for, pending confirmation

SEMI ENCLOSED FUSE HOLDERS

Features:

- Insulated fuse carrier and retainer with finger proof
- Enclosed contacts.
- PCB mounting with 22.6mm pin pitch
- Molded in flame retardant UL94 V0 Polyamide
- Manufactured in accordance with IEC 127-6
- UL, cURus, VDE Semko and CE approved

DFH14N Inc. Spigot

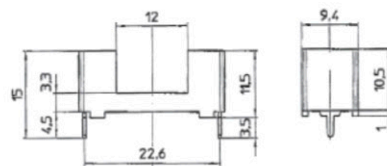

DFH14HBN Fuse Carrier

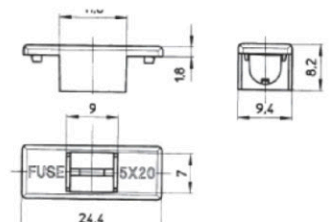

Product Code	Rating	Contacts Material	Contact Resistance	Body Material	Dielectric Strength	Power Dissipation	PCB hole size	Insulation Resistance
DFH14N (Inc. Spigot) Fuse Holder	6.3A / 250V	Tinned Nickel Plated Brass	<5mΩ	UL94 V0 Flame Retardant PA	3KV/60°	2.5W	1.5mm	100MΩ
DFH14HBN Fuse Carrier	6.3A / 250V	Tinned Nickel Plated Brass	<5mΩ	UL94 V0 Flame Retardant PA	3KV/60°	2.5W	1.5mm	100MΩ

SWITCHES - MICROSWITCHES

V4 SUBMINIATURE MICROSWITCHES

Features:

- Rating 5A switching S.P.D.T. (10A to order)
- Long life coil spring mechanism
- UL approved
- Solder, PCB, 90° PCB mounting or 2.8mm quick connect terminals
- Button, lever or roller actuators
- Anti Solder Wicking
- cULus approved



Product Code	Length Depth	Height	Current Rating A Gen	Current Rating A UL	Terminal Type	Special Feature	Rating	Temperature Range	Operating Force Max.	Release Force Max.	Operating Position
DSM40500A	20.1	6.4	5	5	Solder Tag	Button	5A/250VAC	-10°C to +125°C	1.5N	0.3N	8.6 ± 0.4mm
DSM40500B	20.1	6.4	5	5	Quick-Connect	Standard Lever Actuator	5A/250VAC	-10°C to +125°C	1.5N	0.3N	8.6 ± 0.4mm
DSM40500D	20.1	6.4	5	5	PCB Mount	Standard Lever Actuator	5A/250VAC	-10°C to +125°C	1.5N	0.3N	8.6 ± 0.4mm
DSM40500C	20.1	6.4	5	5	PCB Mount	Standard Lever Actuator	5A/250VAC	-10°C to +125°C	1.5N	0.3N	8.6 ± 0.4mm
DSM40510A	20.1	10.8	5	5	Solder Tag	Short Lever	5A/250VAC	-10°C to +125°C	0.25N	0.04N	8.9 ± 1mm
DSM40510B	20.1	10.8	5	5	Quick-Connect	Short Lever	5A/250VAC	-10°C to +125°C	0.25N	0.04N	8.9 ± 1mm
DSM40510C	20.1	10.8	5	5	PCB Mount	Short Lever	5A/250VAC	-10°C to +125°C	0.25N	0.04N	8.9 ± 1mm
DSM40510D	20.1	10.8	5	5	PCB Mount	Short Lever	5A/250VAC	-10°C to +125°C	0.25N	0.04N	8.9 ± 1mm
DSM40511A	20.1	10.8	5	5	Solder Tag	Short Uprturned Lever	5A/250VAC	-10°C to +125°C	-	-	-
DSM40511B	20.1	10.8	5	5	Quick-Connect	Short Uprturned Lever	5A/250VAC	-10°C to +125°C	-	-	-
DSM40511C	20.1	10.8	5	5	PCB Mount	Short Uprturned Lever	5A/250VAC	-10°C to +125°C	-	-	-
DSM40511D	20.1	10.8	5	5	PCB Mount	Short Uprturned Lever	5A/250VAC	-10°C to +125°C	-	-	-
DSM40520A	25.16	10.2	5	5	Solder Tag	Standard Lever	5A/250VAC	-10°C to +125°C	0.25N	0.06N	8.9 ± 1mm
DSM40520B	25.16	10.2	5	5	Quick-Connect	Standard Lever	5A/250VAC	-10°C to +125°C	0.25N	0.06N	8.9 ± 1mm
DSM40520C	25.16	10.2	5	5	PCB Mount	Standard Lever	5A/250VAC	-10°C to +125°C	0.25N	0.06N	8.9 ± 1mm
DSM40520D	25.16	10.2	5	5	90 Deg PCB Mount	Standard Lever	5A/250VAC	-10°C to +125°C	0.25N	0.06N	8.9 ± 1mm
DSM40530A	25.16	10.8	5	5	Solder Tag	Long Lever	5A/250VAC	-10°C to +125°C	0.25N	0.03N	9.6 ± 2mm
DSM40530B	25.16	10.8	5	5	Quick-Connect	Long Lever	5A/250VAC	-10°C to +125°C	0.25N	0.03N	9.6 ± 2mm
DSM40530C	25.16	10.8	5	5	PCB Mount	Long Lever	5A/250VAC	-10°C to +125°C	0.25N	0.03N	9.6 ± 2mm
DSM40530D	25.16	10.8	5	5	90 Deg PCB Mount	Long Lever	5A/250VAC	-10°C to +125°C	0.25N	0.03N	9.6 ± 2mm
DSM40530F	20.1	6.4	5	5	PCB Mount	Long Lever	5A/250VAC	-10°C to +125°C	0.25N	0.03N	9.6 ± 2mm
DSM40540A	25.16	10.8	5	5	Solder Tag	Simulated Roller	5A/250VAC	-10°C to +125°C	0.25N	0.04N	12 ± 1.2mm
DSM40540B	25.16	10.8	5	5	Quick-Connect	Simulated Roller	5A/250VAC	-10°C to +125°C	0.25N	0.04N	12 ± 1.2mm
DSM40540C	25.16	10.8	5	5	PCB Mount	Simulated Roller	5A/250VAC	-10°C to +125°C	0.25N	0.04N	12 ± 1.2mm
DSM40540D	25.16	10.8	5	5	90 Deg PCB Mount	Simulated Roller	5A/250VAC	-10°C to +125°C	0.25N	0.04N	12 ± 1.2mm
DSM40550A	25.16	10.8	5	5	Solder Tag	Standard Roller	5A/250VAC	-10°C to +125°C	0.25N	0.04N	15.2 ± 1mm
DSM40550B	25.16	10.8	5	5	Quick-Connect	Standard Roller	5A/250VAC	-10°C to +125°C	0.25N	0.04N	15.2 ± 1mm
DSM40550C	25.16	10.8	5	5	PCB Mount	Standard Roller	5A/250VAC	-10°C to +125°C	0.25N	0.04N	15.2 ± 1mm
DSM40550D	25.16	10.8	5	5	90 Deg PCB Mount	Standard Roller	5A/250VAC	-10°C to +125°C	0.25N	0.04N	15.2 ± 1mm
DSM40570A	25.16	10.8	5	5	Solder Tag	Wave Lever	5A/250VAC	-10°C to +125°C	-	-	-
DSM40570B	25.16	10.8	5	5	Quick-Connect	Wave Lever	5A/250VAC	-10°C to +125°C	-	-	-
DSM40570C	25.16	10.8	5	5	PCB Mount	Wave Lever	5A/250VAC	-10°C to +125°C	-	-	-
DSM40570D	25.16	10.8	5	5	90 Deg PCB Mount	Wave Lever	5A/250VAC	-10°C to +125°C	-	-	-
DSM40580A	25.16	10.8	5	5	PCB Mount	Extra Long Lever	5A/250VAC	-10°C to +125°C	0.1N	0.02N	9.8 ± 1.5mm
DSM40580B	25.16	10.8	5	5	Quick-Connect	Extra Long Lever	5A/250VAC	-10°C to +125°C	0.1N	0.02N	9.8 ± 1.5mm
DSM40580C	25.16	10.8	5	5	Solder Tag	Extra Long Lever	5A/250VAC	-10°C to +125°C	0.1N	0.02N	9.8 ± 1.5mm
DSM40580D	25.16	10.8	5	5	90 Deg PCB Mount	Extra Long Lever	5A/250VAC	-10°C to +125°C	0.1N	0.02N	9.8 ± 1.5mm
DSM40581A	25.16	10.8	5	5	Solder Tag	Extra Long Stepped Lever	5A/250VAC	-10°C to +125°C	-	-	-
DSM40581B	25.16	10.8	5	5	Quick-Connect	Extra Long Stepped Lever	5A/250VAC	-10°C to +125°C	-	-	-
DSM40581C	25.16	10.8	5	5	PCB Mount	Extra Long Stepped Lever	5A/250VAC	-10°C to +125°C	-	-	-
DSM40581D	25.16	10.8	5	5	90 Deg PCB Mount	Extra Long Stepped Lever	5A/250VAC	-10°C to +125°C	-	-	-

SWITCHES - MICROSWITCHES

V3 MINIATURE MICROSWITCHES

Features:

- Rating 5A, 10A, 15A Switching S.P.D.T (15A to order)
- Coil spring mechanism
- 6.3mm (.250), 4.8mm (.187) quick connect solder & screw terminals
-  approved
- Insulation strength 100MΩ min/500VDC
- Electrical life: 50,000 operation min

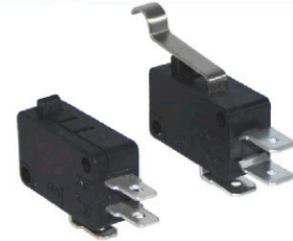

Product Code	Length Depth	Height	Current Rating A Gen	Current Rating A UL	Terminal Type	Acuator Style	Temperature Range	Operating Force Max.	Release Force Max.	Operating Position
DSM3050A	27.8	15.9	5	5	Solder	Button Actuator	-10°C to +105°C	3N	0.7N	14.9 ± 0.5mm
DSM3050B	27.8	15.9	5	5	Screw Terminal	Button Actuator	-10°C to +105°C	3N	0.7N	14.9 ± 0.5mm
DSM3050C	27.8	15.9	5	5	Quick-Connect	Button Actuator	-10°C to +105°C	3N	0.7N	14.9 ± 0.5mm
DSM3050D	27.8	15.9	5	5	Quick-Connect	Button Actuator	-10°C to +105°C	3N	0.7N	14.9 ± 0.5mm
DSM30510A	27.8	15.9	5	5	Solder Tag	Short Lever Actuator	-10°C to +105°C	3N	0.7N	15.8 ± 0.5mm
DSM30510B	27.8	15.9	5	5	Screw Terminal	Short Lever Actuator	-10°C to +105°C	3N	0.7N	15.8 ± 0.5mm
DSM30510C	27.8	15.9	5	5	Quick-Connect	Short Lever Actuator	-10°C to +105°C	3N	0.7N	15.8 ± 0.5mm
DSM30510D	27.8	15.9	5	5	Quick-Connect	Short Lever Actuator	-10°C to +105°C	3N	0.7N	15.8 ± 0.5mm
DSM30520A	36.5	15.9	5	5	Solder Tag	Standard Level Actuator	-10°C to +105°C	0.7N	0.15N	16.3 ± 1.2mm
DSM30520B	36.5	15.9	5	5	Screw Terminal	Standard Level Actuator	-10°C to +105°C	0.7N	0.15N	16.3 ± 1.2mm
DSM30520C	36.5	15.9	5	5	Quick-Connect	Standard Level Actuator	-10°C to +105°C	0.7N	0.15N	16.3 ± 1.2mm
DSM30520D	36.5	15.9	5	5	Quick-Connect	Standard Level Actuator	-10°C to +105°C	0.7N	0.15N	16.3 ± 1.2mm
DSM30530A	59.5	15.9	5	5	Solder Tag	Long Level Actuator	-10°C to +105°C	0.25N	0.05N	17.2 ± 2.5mm
DSM30530B	59.5	15.9	5	5	Screw Terminal	Long Level Actuator	-10°C to +105°C	0.25N	0.05N	17.2 ± 2.5mm
DSM30530C	59.5	15.9	5	5	Quick-Connect	Long Level Actuator	-10°C to +105°C	0.25N	0.05N	17.2 ± 2.5mm
DSM30530D	59.5	15.9	5	5	Quick-Connect	Long Level Actuator	-10°C to +105°C	0.25N	0.05N	17.2 ± 2.5mm
DSM30531A	63	15.9	5	5	Solder Tag	Long Wide Level Actuator	-10°C to +105°C	0.25N	0.07N	17.2 ± 2.5mm
DSM30531B	63	15.9	5	5	Screw Terminal	Long Wide Level Actuator	-10°C to +105°C	0.25N	0.07N	17.2 ± 2.5mm
DSM30531C	63	15.9	5	5	Quick-Connect	Long Wide Level Actuator	-10°C to +105°C	0.25N	0.07N	17.2 ± 2.5mm
DSM30531D	63	15.9	5	5	Quick-Connect	Long Wide Level Actuator	-10°C to +105°C	0.25N	0.07N	17.2 ± 2.5mm
DSM30540A	32.6	15.9	5	5	Solder Tag	Simulated Roller Actuator	-10°C to +105°C	1.05N	0.2N	19.5 ± 2.5mm
DSM30540B	32.6	15.9	5	5	Screw Terminal	Simulated Roller Actuator	-10°C to +105°C	1.05N	0.2N	19.5 ± 2.5mm
DSM30540C	32.6	15.9	5	5	Quick-Connect	Simulated Roller Actuator	-10°C to +105°C	1.05N	0.2N	19.5 ± 2.5mm
DSM30540D	32.6	15.9	5	5	Quick-Connect	Simulated Roller Actuator	-10°C to +105°C	1.05N	0.2N	19.5 ± 2.5mm
DSM30550A	20.2	15.9	5	5	Solder Tag	Standard Level Actuator	10°C to +105°C	3.2N	0.6N	21.4 ± 0.6mm
DSM30550B	20.2	15.9	5	5	Screw Terminal	Standard Level Actuator	10°C to +105°C	3.2N	0.6N	21.4 ± 0.6mm
DSM30550C	20.2	15.9	5	5	Quick-Connect	Standard Level Actuator	10°C to +105°C	3.2N	0.6N	21.4 ± 0.6mm
DSM30550D	20.2	15.9	5	5	Quick-Connect	Standard Level Actuator	10°C to +105°C	3.2N	0.6N	21.4 ± 0.6mm
DSM30560A	34	15.9	5	5	Solder Tag	Long Arm Roller Actuator	10°C to +105°C	0.8N	0.15N	21.4 ± 1.2mm
DSM30560B	34	15.9	5	5	Screw Terminal	Long Arm Roller Actuator	10°C to +105°C	0.8N	0.15N	21.4 ± 1.2mm
DSM30560C	34	15.9	5	5	Quick-Connect	Long Arm Roller Actuator	10°C to +105°C	0.8N	0.15N	21.4 ± 1.2mm
DSM30560D	34	15.9	5	5	Quick-Connect	Long Arm Roller Actuator	10°C to +105°C	0.8N	0.15N	21.4 ± 1.2mm
DND515213-LED-T/AMB	-	-	-	-	-	-	-	-	-	-

SWITCHES - MICROSWITCHES

V3 MINIATURE MICROSWITCHES

Features:

- Rating 5A, 10A, 15A Switching S.P.D.T (15A to order)
- Coil spring mechanism
- 6.3mm (.250), 4.8mm (.187) quick connect solder & screw terminals
- approved
- Insulation strength 100MQ min/500VDC
- Electrical life: 50,000 operation min

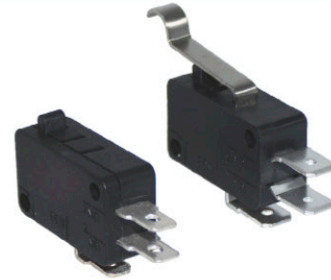

Product Code	Length Depth	Height	Current Rating A Gen	Current Rating A UL	Terminal Type	Actuator Style	Temperature Range	Operating Force Max.	Release Force Max.	Operating Position
DSM31000A	27.8	15.9	10	10	Solder Tag	Button Actuator	-10°C to +105°C	3N	0.7N	14.9 ± 0.4mm
DSM31000B	27.8	15.9	10	10	Screw Terminal	Button Actuator	-10°C to +105°C	3N	0.7N	14.9 ± 0.4mm
DSM31000C	27.8	15.9	10	10	Quick-Connect	Button Actuator	-10°C to +105°C	3N	0.7N	14.9 ± 0.4mm
DSM31000D	27.8	15.9	10	10	Quick-Connect	Button Actuator	-10°C to +105°C	3N	0.7N	14.9 ± 0.4mm
DSM31010A	27.8	15.9	10	10	Solder Tag	Short Level Actuator	-10°C to +105°C	3N	0.7N	15.8 ± 0.5mm
DSM31010B	27.8	15.9	10	10	Screw Terminal	Short Level Actuator	-10°C to +105°C	3N	0.7N	15.8 ± 0.5mm
DSM31010C	27.8	15.9	10	10	Quick-Connect	Short Level Actuator	-10°C to +105°C	3N	0.7N	15.8 ± 0.5mm
DSM31010D	27.8	15.9	10	10	Quick-Connect	Short Level Actuator	-10°C to +105°C	3N	0.7N	15.8 ± 0.5mm
DSM31020A	35.6	15.9	10	10	Solder Tag	Standard Level Actuator	-10°C to +105°C	0.7N	0.15N	16.3 ± 1.2mm
DSM31020B	35.6	15.9	10	10	Screw Terminal	Standard Level Actuator	-10°C to +105°C	0.7N	0.15N	16.3 ± 1.2mm
DSM31020C	35.6	15.9	10	10	Quick-Connect	Standard Level Actuator	-10°C to +105°C	0.7N	0.15N	16.3 ± 1.2mm
DSM31020D	35.6	15.9	10	10	Quick-Connect	Standard Level Actuator	-10°C to +105°C	0.7N	0.15N	16.3 ± 1.2mm
DSM31030A	59.5	15.9	10	10	Solder Tag	Long Level Actuator	-10°C to +105°C	0.25N	0.05N	17.2 ± 2.5mm
DSM31030B	59.5	15.9	10	10	Screw Terminal	Long Level Actuator	-10°C to +105°C	0.25N	0.05N	17.2 ± 2.5mm
DSM31030C	59.5	15.9	10	10	Quick-Connect	Long Level Actuator	-10°C to +105°C	0.25N	0.05N	17.2 ± 2.5mm
DSM31030D	59.5	15.9	10	10	Quick-Connect	Long Level Actuator	-10°C to +105°C	0.25N	0.05N	17.2 ± 2.5mm
DSM31040A	32.6	15.9	10	10	Solder Tag	Simulated Roller Actuator	-10°C to +105°C	1.05N	0.2N	19.5 ± 2.5mm
DSM31040B	32.6	15.9	10	10	Screw Terminal	Simulated Roller Actuator	-10°C to +105°C	1.05N	0.2N	19.5 ± 2.5mm
DSM31040C	32.6	15.9	10	10	Quick-Connect	Simulated Roller Actuator	-10°C to +105°C	1.05N	0.2N	19.5 ± 2.5mm
DSM31040D	32.6	15.9	10	10	Quick-Connect	Simulated Roller Actuator	-10°C to +105°C	1.05N	0.2N	19.5 ± 2.5mm
DSM31050A	20.2	15.9	10	10	Solder Tag	Standard Level Actuator	-10°C to +105°C	3.2N	0.6N	21.4 ± 0.6mm
DSM31050B	20.2	15.9	10	10	Screw Terminal	Standard Level Actuator	-10°C to +105°C	3.2N	0.6N	21.4 ± 0.6mm
DSM31050C	20.2	15.9	10	10	Quick-Connect	Standard Level Actuator	-10°C to +105°C	3.2N	0.6N	21.4 ± 0.6mm
DSM31050D	20.2	15.9	10	10	Quick-Connect	Standard Level Actuator	-10°C to +105°C	3.2N	0.6N	21.4 ± 0.6mm
DSM31060A	34	15.9	10	10	Solder Tag	Long Arm Roller Actuator	10°C to +105°C	0.8N	0.15N	21.4 ± 1.2mm
DSM31060B	34	15.9	10	10	Screw Terminal	Long Arm Roller Actuator	10°C to +105°C	0.8N	0.15N	21.4 ± 1.2mm
DSM31060C	34	15.9	10	10	Quick-Connect	Long Arm Roller Actuator	10°C to +105°C	0.8N	0.15N	21.4 ± 1.2mm
DSM31060D	34	15.9	10	10	Quick-Connect	Long Arm Roller Actuator	10°C to +105°C	0.8N	0.15N	21.4 ± 1.2mm

SWITCHES - MICROSWITCHES

V3 MINIATURE MICROSWITCHES

Features:

- Rating 5A, 10A, 15A Switching S.P.D.T (15A to order)
- Coil spring mechanism
- 6.3mm (.250), 4.8mm (.187) quick connect solder & screw terminals
-  approved
- Insulation strength 100MΩ min/500VDC
- Electrical life: 50,000 operation min

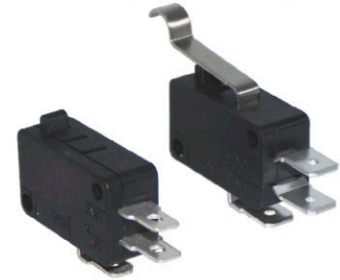

Product Code	Length Depth	Height	Current Rating A Gen	Current Rating A UL	Terminal Type	Actuator Style	Temperature Range	Operating Force Max.	Release Force Max.	Operating Position
DSM31500A	27.8	15.9	15	15	Solder Tag	Button Actuator	-10°C to +105°C	3N	0.7N	14.9 ± 0.4mm
DSM31500B	27.8	15.9	15	15	Screw Terminal	Button Actuator	-10°C to +105°C	3N	0.7N	14.9 ± 0.4mm
DSM31500C	27.8	15.9	15	15	Quick-Connect	Button Actuator	-10°C to +105°C	3N	0.7N	14.9 ± 0.4mm
DSM31500D	27.8	15.9	15	15	Quick-Connect	Button Actuator	-10°C to +105°C	3N	0.7N	14.9 ± 0.4mm
DSM31510A	27.8	15.9	15	15	Solder Tag	Short Level Actuator	-10°C to +105°C	3N	0.7N	15.8 ± 0.5mm
DSM31510B	27.8	15.9	15	15	Screw Terminal	Short Level Actuator	-10°C to +105°C	3N	0.7N	15.8 ± 0.5mm
DSM31510C	27.8	15.9	15	15	Quick-Connect	Short Level Actuator	-10°C to +105°C	3N	0.7N	15.8 ± 0.5mm
DSM31510D	27.8	15.9	15	15	Quick-Connect	Short Level Actuator	-10°C to +105°C	3N	0.7N	15.8 ± 0.5mm
DSM31520A	36.5	15.9	15	15	Solder Tag	Standard Level Actuator	-10°C to +105°C	0.7N	0.15N	16.3 ± 1.2mm
DSM31520B	36.5	15.9	15	15	Screw Terminal	Standard Level Actuator	-10°C to +105°C	0.7N	0.15N	16.3 ± 1.2mm
DSM31520C	36.5	15.9	15	15	Quick-Connect	Standard Level Actuator	-10°C to +105°C	0.7N	0.15N	16.3 ± 1.2mm
DSM31520D	36.5	15.9	15	15	Quick-Connect	Standard Level Actuator	-10°C to +105°C	0.7N	0.15N	16.3 ± 1.2mm
DSM31530A	59.5	15.9	15	15	Solder Tag	Long Level Actuator	-10°C to +105°C	0.25N	0.05N	17.2 ± 2.5mm
DSM31530B	59.5	15.9	15	15	Screw Terminal	Long Level Actuator	-10°C to +105°C	0.25N	0.05N	17.2 ± 2.5mm
DSM31530C	59.5	15.9	15	15	Quick-Connect	Long Level Actuator	-10°C to +105°C	0.25N	0.05N	17.2 ± 2.5mm
DSM31530D	59.5	15.9	15	15	Quick-Connect	Long Level Actuator	-10°C to +105°C	0.25N	0.05N	17.2 ± 2.5mm
DSM31531A	63	15.9	15	15	Solder Tag	Long Wide Level Actuator	-10°C to +105°C	0.25N	0.07N	17.2 ± 2.5mm
DSM31531B	63	15.9	15	15	Screw Terminal	Long Wide Level Actuator	-10°C to +105°C	0.25N	0.07N	17.2 ± 2.5mm
DSM31531C	63	15.9	15	15	Quick-Connect	Long Wide Level Actuator	-10°C to +105°C	0.25N	0.07N	17.2 ± 2.5mm
DSM31531D	63	15.9	15	15	Quick-Connect	Long Wide Level Actuator	-10°C to +105°C	0.25N	0.07N	17.2 ± 2.5mm
DSM31540A	32.6	15.9	15	15	Solder Tag	Simulated Roller Actuator	-10°C to +105°C	1.05N	0.2N	19.5 ± 2.5mm
DSM31540B	32.6	15.9	15	15	Screw Terminal	Simulated Roller Actuator	-10°C to +105°C	1.05N	0.2N	19.5 ± 2.5mm
DSM31540C	32.6	15.9	15	15	Quick-Connect	Simulated Roller Actuator	-10°C to +105°C	1.05N	0.2N	19.5 ± 2.5mm
DSM31540D	32.6	15.9	15	15	Quick-Connect	Simulated Roller Actuator	-10°C to +105°C	1.05N	0.2N	19.5 ± 2.5mm
DSM31550A	20.2	15.9	15	15	Solder Tag	Standard Level Actuator	-10°C to +105°C	3.2N	0.6N	21.4 ± 0.6mm
DSM31550B	20.2	15.9	15	15	Screw Terminal	Standard Level Actuator	-10°C to +105°C	3.2N	0.6N	21.4 ± 0.6mm
DSM31550C	20.2	15.9	15	15	Quick-Connect	Standard Level Actuator	-10°C to +105°C	3.2N	0.6N	21.4 ± 0.6mm
DSM31550D	20.2	15.9	15	15	Quick-Connect	Standard Level Actuator	-10°C to +105°C	3.2N	0.6N	21.4 ± 0.6mm
DSM31560A	34	15.9	15	15	Solder Tag	Long Arm Roller Actuator	-10°C to +105°C	0.8N	0.15N	21.4 ± 1.2mm
DSM31560B	34	15.9	15	15	Screw Terminal	Long Arm Roller Actuator	-10°C to +105°C	0.8N	0.15N	21.4 ± 1.2mm
DSM31560C	34	15.9	15	15	Quick-Connect	Long Arm Roller Actuator	-10°C to +105°C	0.8N	0.15N	21.4 ± 1.2mm
DSM31560D	34	15.9	15	15	Quick-Connect	Long Arm Roller Actuator	-10°C to +105°C	0.8N	0.15N	21.4 ± 1.2mm

SWITCHES - MICROSWITCHES

ULTRA MINIATURE & INDUSTRIAL MICROSWITCHES

Features:

- Rating 3A switching S.P.D.T.
- Space saving
- Electrical life: 10,000 electrical minutes

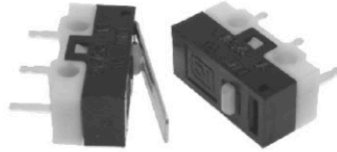

ULTRA MINIATURE MICROSWITCHES

Product Code	Length Depth	Height	Current Rating A Gen	Current Rating A UL	Terminal Type	Actuator Style	Rating	Temperature Range	Operating Force Max.	Release Force Max.	Operating Position
DMU0100	12.8	12	1	1	Brass Alloy H65 Silver Plated	Button	3A/125VAC	-10°C to +85°C	1.5N	0.08N	5.5 ± 0.3mm
DMU0101	12.8	12	1	1	Brass Alloy H65 Silver Plated	Tapered Lever	3A/125VAC	-10°C to +85°C	0.23N	0.03N	6.2 ± 0.8mm
DMU0106	12.8	12	1	1	Brass Alloy H65 Silver Plated	Parallel Lever	3A/125VAC	-10°C to +85°C	0.23N	0.03N	7 ± 1.2mm
DMU0140	12.8	12	1	1	Brass Alloy H65 Silver Plated	Simulated Roller	3A/125VAC	-10°C to +85°C	0.4N	0.05N	8.2 ± 1.5mm

debox[®] SL

REG. DESIGN: 002553735

**NO SCREWS,
NO TOOLS,
NO HASSLE**



SEE PAGE 8

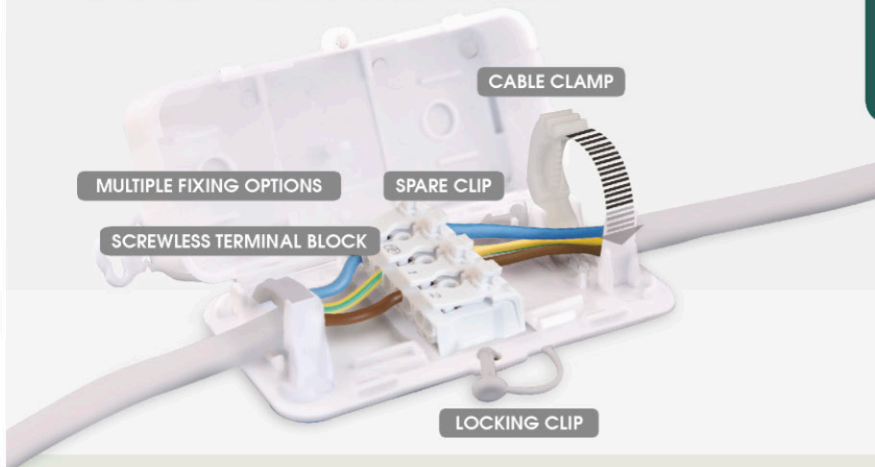

SCREWLESS TERMINAL BLOCK INCLUDED

- ✓ Tool-less box assembly.
- ✓ Contains 1 x 16A approved 4 pole 100% screwless terminal block. **NO ADDITIONAL PURCHASE REQUIRED.**
- ✓ Saves time & money.
- ✓ Maintenance Free.
- ✓ Flame Retardant UL94-V0 housing.
- ✓ IP20 Protected.

CREATED BY hylec • www.hylec-apl.com

SCAN ME
TO FIND
OUT MORE



SWITCHES

TACT SWITCHES



Features:

- Advanced switch Technology
- Positive tactile action
- Tamper proof application
- Flow solder wash-away cleaning
- Through-hole PCB, surface mount & horizontal terminals
- Can be supplied taped for auto-insertion, add suffix /T



SURFACE MOUNT



THROUGH-HOLE

TACT SWITCHES - 3.5 X 6 MM (COMPACT DESIGN)

Product Code	Length Depth	Height	Width	Current Rating A Gen	Rated Voltage V Gen	Terminal Type	Pitch (mm)
DST35605S	6.6	3.5	3.5	0.051	12	Surface Mount	6.4
DST35643S	6.6	3.5	3.5	0.051	12	Surface Mount	6.4
DST35605T	6	3.4	3.5	0.05	12	Through-Hole	6.4
DST35643T	6	3.4	3.5	0.051	12	Through-Hole	6.4

TACT SWITCHES - 6 X 6 MM

Product Code	Length Depth	Height	Width	Current Rating A Gen	Rated Voltage V Gen	Terminal Type	Pitch (mm)	Button Styles
DST06S05S	9	5	6	0.05	12	Surface Mount	6.5 +0.5 -0.1	Square & round button styles
DST06S05S	9	8	6	0.05	12	Surface Mount	6.5 +0.5 -0.1	Square & round button styles
DST06S43S	9	4.3	6	0.05	12	Surface Mount	6.5 +0.5 -0.1	Square & round button styles
DST06S05T	7.9	5	4.5	0.05	12	Through-Hole	6.5 +0.5 -0.1	Square & round button styles
DST06S08T	7.9	8	4.5	0.05	12	Through-Hole	6.5 +0.5 -0.1	Square & round button styles
DST06S0AT	7.9	7.4	4.5	0.05	12	Through-Hole	6.5 +0.5 -0.1	Square & round button styles
DST06S13T	7.9	13	4.5	0.05	12	Through-Hole	6.5 +0.5 -0.1	Square & round button styles
DST06S43T	7.9	4.3	4.5	0.05	12	Through-Hole	6.5 +0.5 -0.1	Square & round button styles
DST06S73T	7.9	7.3	4.5	0.05	12	Through-Hole	6.5 +0.5 -0.1	Square & round button styles
DST06S95T	7.9	9.5	4.5	0.05	12	Through-Hole	6.5 +0.5 -0.1	Square & round button styles
DST06S05H	8.4	5	4.5	0.05	12	Through-Hole 90 Degree	6.5 +0.5 -0.1	Square & round button styles
DST06S08H	8.4	8	4.5	0.05	12	Through-Hole 90 Degree	6.5 +0.5 -0.1	Square & round button styles
DST06S0H	8.4	5	4.5	0.05	12	Through-Hole 90 Degree	6.5 +0.5 -0.1	Square & round button styles
DST06S43H	8.4	4.3	4.5	0.05	12	Through-Hole 90 Degree	6.5 +0.5 -0.1	Square & round button styles



THROUGH-HOLE



THROUGH-HOLE 90°

TACT SWITCHES - 12 X 12 MM

Product Code	Length Depth	Height	Width	Current Rating A Gen	Rated Voltage V Gen	Terminal Type	Pitch (mm)	Button Styles
DST12S0AS	14.1	7.3	4	0.05	12	Surface Mount	6.4	Square & round button styles Choice of caps
DST12S43S	14.1	4.3	4	0.05	12	Surface Mount	6.4	Square & round button styles Choice of caps
DST12S0AT	14.1	7.3	4	0.05	12	Through-Hole	6.4	Square & round button styles Choice of caps
DST12S43T	8.4	4.3	4.5	0.05	12	Through-Hole	6.4	Square & round button styles Choice of caps



SURFACE MOUNT



THROUGH-HOLE

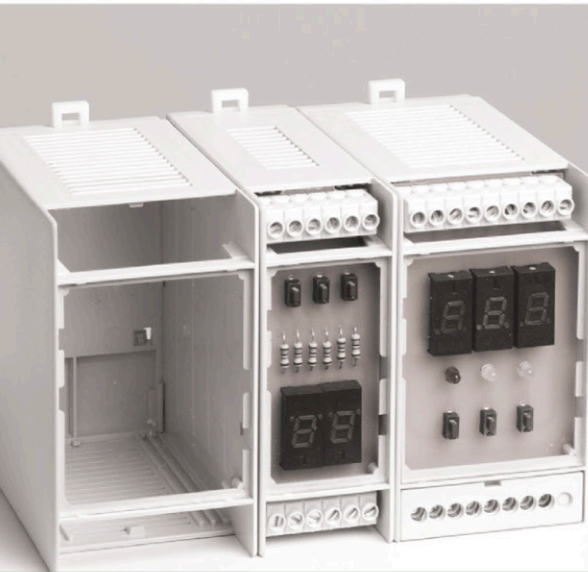

PCB ENCLOSURES AND DIN RAIL SUPPORTS

Features:

- Materials: Flame retardant UL94-V0 Polycarbonate
- Colours: Grey (G) / RAL 7035
- Cover colours: Grey (G), red transparent (R) or clear (C)
- For use with DIN Rail or surface mount
- Snap-on kits for easy assembly
- Snap-on base
- Suitable for PCB thickness up to 1.6 mm
- Holds up to 3 PCB's horizontally and 2-4 vertically
- Option for incorporating a screw mounted heat sink
- Snap-on terminal covers with slots for pitches 5 /7.5 /10
- Snap-on terminal covers with knockout holes for pitch 5/10
- 73mm with hinged cover in grey (G) /RAL 7035, red transparent (R) or clear (C)
- All enclosures can be customised



FRONT PANELS FOR 60MM & 73MM DIN RAIL ENCLOSURES

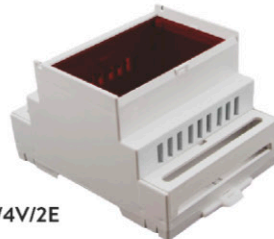
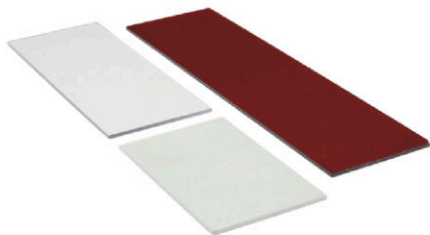

DNMB/4V/2E

Product Code	Item	Colour	Width (mm)	Length (mm)	Height (mm)
DNMB/1PG	Enclosure 1	Grey	42	14.5	2
DNMB/2PG	Enclosure 2	Grey	42	32	2
DNMB/3PG	Enclosure 3	Grey	42	49.5	2
DNMB/4PG	Enclosure 4	Grey	42	67	2
DNMB/6PG	Enclosure 6	Grey	42	102	2
DNMB/9PG	Enclosure 9	Grey	42	154.5	2
DNMB/1PC	Enclosure 1	Clear	42	14.5	2
DNMB/2PC	Enclosure 2	Clear	42	32	2
DNMB/3PC	Enclosure 3	Clear	42	49.5	2
DNMB/4PC	Enclosure 4	Clear	42	67	2
DNMB/6PC	Enclosure 6	Clear	42	102	2
DNMB/9PC	Enclosure 9	Clear	42	154.5	2
DNMB/1PR	Enclosure 1	Red Transparent	42	14.5	2
DNMB/2PR	Enclosure 2	Red Transparent	42	32	2
DNMB/3PR	Enclosure 3	Red Transparent	42	49.5	2
DNMB/4PR	Enclosure 4	Red Transparent	42	67	2
DNMB/6PR	Enclosure 6	Red Transparent	42	102	2
DNMB/9PR	Enclosure 9	Red Transparent	42	154.5	2

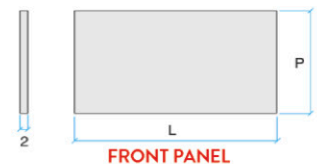

FRONT PANEL

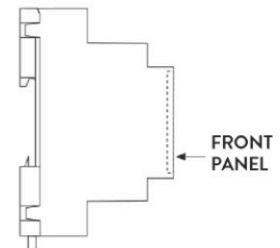

60MM ENCLOSURE WITH OPEN TOP

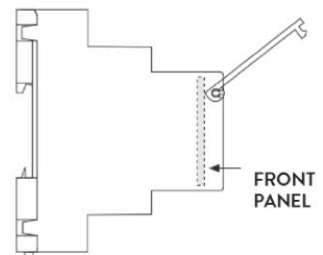

73MM ENCLOSURE WITH HINGE COVER & PANEL

60MM DIN RAIL ENCLOSURES SOLID TOP



DNMB/2/2E



DNMB/3ST/2

Product Code	Item	Width (mm)	Length (mm)	Height (mm)
DNMB/1ST/2	Enclosure 1	90	18.5	60
DNMB/2ST/2	Enclosure 2	90	36	60
DNMB/3ST/2	Enclosure 3	90	53.5	60
DNMB/4ST/2	Enclosure 4	90	71	60
DNMB/5ST/2	Enclosure 6	90	106	60
DNMB/6ST/2	Enclosure 9	90	158.5	60

TERMINAL COVERS

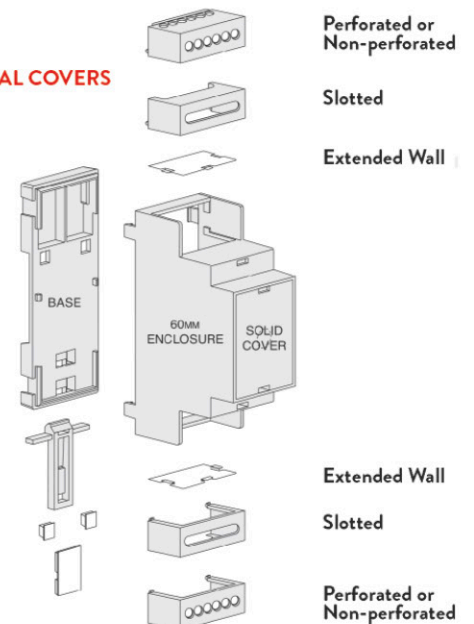

PCB ENCLOSURES AND DIN RAIL SUPPORTS

PCB ENCLOSURES

60MM DIN RAIL ENCLOSURES - OPEN TOP

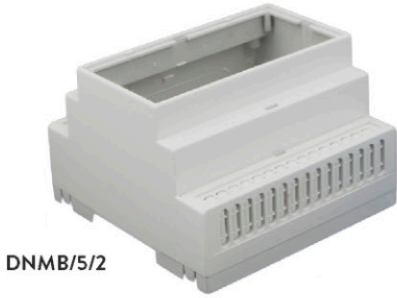

OPEN TOP

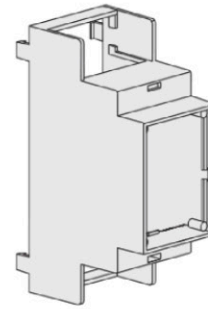

Product Code	Item	Width (mm)	Length (mm)	Height (mm)
DNMB/1/2	Enclosure 1	90	18.5	60
DNMB/2/2	Enclosure 2	90	36	60
DNMB/3/2	Enclosure 3	90	53.5	60
DNMB/4/2	Enclosure 4	90	71	60
DNMB/6/2	Enclosure 6	90	106	60
DNMB/9/2	Enclosure 9	90	158.5	60

73MM DIN RAIL OPEN TOP ENCLOSURE WITH HINGED COVER



TERMINAL COVERS



Perforated or Non-perforated



Slotted



Extended Wall

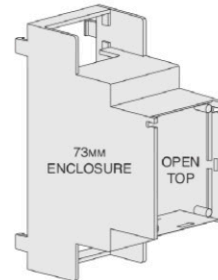

Extended Wall



Slotted



Perforated or Non-perforated

Product Code	Item	Width (mm)	Length (mm)	Height (mm)
DNMB/1E/2	Enclosure 1	90	18.5	73
DNMB/2E/2	Enclosure 2	90	36	73
DNMB/3E/2	Enclosure 3	90	53.5	73
DNMB/4E/2	Enclosure 4	90	71	73
DNMB/6E/2	Enclosure 6	90	106	73
DNMB/9E/2	Enclosure 9	90	158.5	73

EXTENDED WALL

Product Code	Item	Length (mm)	Height (mm)
DNMB/1WE	Enclosure 1	14.0	19.5
DNMB/2WE	Enclosure 2	31.0	19.5
DNMB/3WE	Enclosure 3	48.2	19.5
DNMB/4WE	Enclosure 4	66.0	19.5

Features:

- Materials: Flame retardant UL94-V0 Polycarbonate
- Colours: Grey (G) / RAL 7035
- Cover colours: Grey (G), red transparent (R) or clear (C)
- For use with DIN Rail or surface mount
- Snap-on kits for easy assembly
- Snap-on base
- Suitable for PCB thickness up to 1.6 mm
- Holds up to 3 PCB's horizontally and 2-4 vertically
- Option for incorporating a screw mounted heat sink
- Snap-on terminal covers with slots for pitches 5 /7.5 /10
- Snap-on terminal covers with knockout holes for pitch 5/10
- 73mm with hinged cover in grey (G) /RAL 7035, red transparent (R) or clear (C)
- All enclosures can be customised

100MM DIN RAIL ENCLOSURES - VENTED SOLID TOP



DNCB/4V ST/2



DNCB/3V ST/2

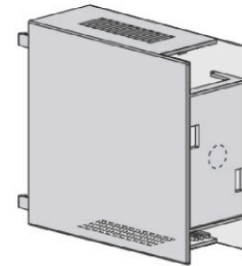

Product Code	Item	Width (mm)	Length (mm)	Height (mm)
DNCB/2VST	Enclosure 1	90	36	100
DNCB/3VST	Enclosure 2	90	53.5	100
DNCB/4VST	Enclosure 3	90	71	100

100MM DIN RAIL ENCLOSURES - VENTED OPEN TOP



DNCB/2V/2



DNCB/4V/2

TERMINAL COVERS

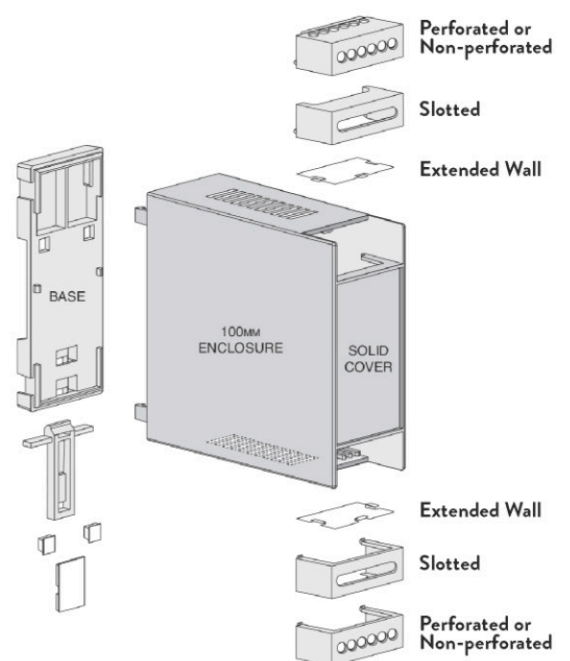

Product Code	Item	Width (mm)	Length (mm)	Height (mm)
DNCB/2V	Enclosure 2	90	36	100
DNCB/3V	Enclosure 3	90	53.5	100
DNCB/4V	Enclosure 4	90	71	100

PCB ENCLOSURES AND DIN RAIL SUPPORTS

PCB ENCLOSURES

HINGED COVERS FOR 73MM DIN RAIL ENCLOSURES

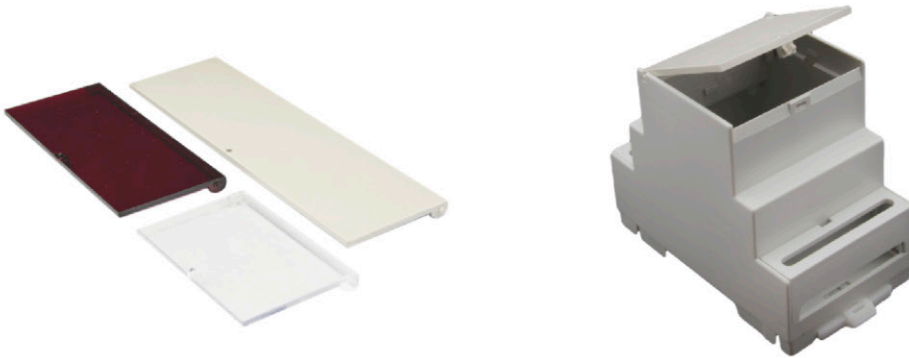

Product Code	Item	Colour
DNMB/1HPG	Enclosure 1	Grey
DNMB/2HPG	Enclosure 2	Grey
DNMB/3HPG	Enclosure 3	Grey
DNMB/4HPG	Enclosure 4	Grey
DNMB/6HPG	Enclosure 6	Grey
DNMB/9HPG	Enclosure 9	Grey
DNMB/1HPC	Enclosure 1	Clear
DNMB/2HPC	Enclosure 2	Clear
DNMB/3HPC	Enclosure 3	Clear
DNMB/4HPC	Enclosure 4	Clear
DNMB/6HPC	Enclosure 6	Clear
DNMB/9HPC	Enclosure 9	Clear
DNMB/1HPR	Enclosure 1	Red Transparent
DNMB/2HPR	Enclosure 2	Red Transparent
DNMB/3HPR	Enclosure 3	Red Transparent
DNMB/4HPR	Enclosure 4	Red Transparent
DNMB/6HPR	Enclosure 6	Red Transparent
DNMB/9HPR	Enclosure 9	Red Transparent

HINGED COVER FOR 73MM ENCLOSURES

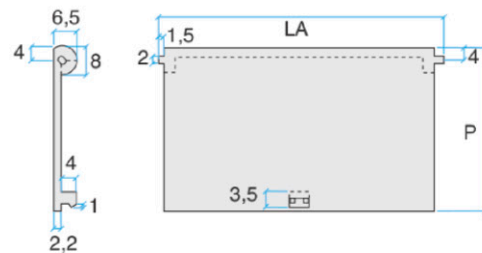

ATTACHING THE HINGE COVER TO THE ENCLOSURE

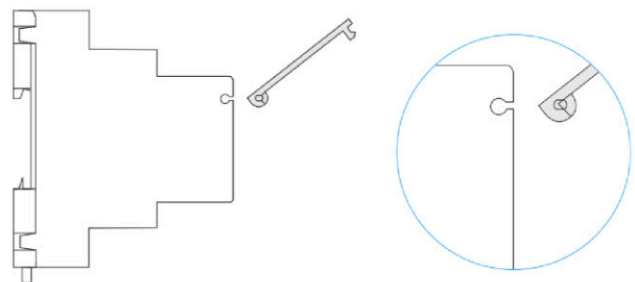

Features:

- Materials: Flame retardant UL94-V0 Polycarbonate
- Colours: Grey (G) / RAL 7035
- Cover colours: Grey (G), red transparent (R) or clear (C)
- For use with DIN Rail or surface mount
- Snap-on kits for easy assembly
- Snap-on base
- Suitable for PCB thickness up to 1.6 mm
- Holds up to 3 PCB's horizontally and 2-4 vertically
- Option for incorporating a screw mounted heat sink
- Snap-on terminal covers with slots for pitches 5 /7.5 /10
- Snap-on terminal covers with knockout holes for pitch 5/10
- 73mm with hinged cover in grey (G) /RAL 7035, red transparent (R) or clear (C)
- All enclosures can be customised

NON-PERFORATED & PERFORATED TERMINAL COVERS

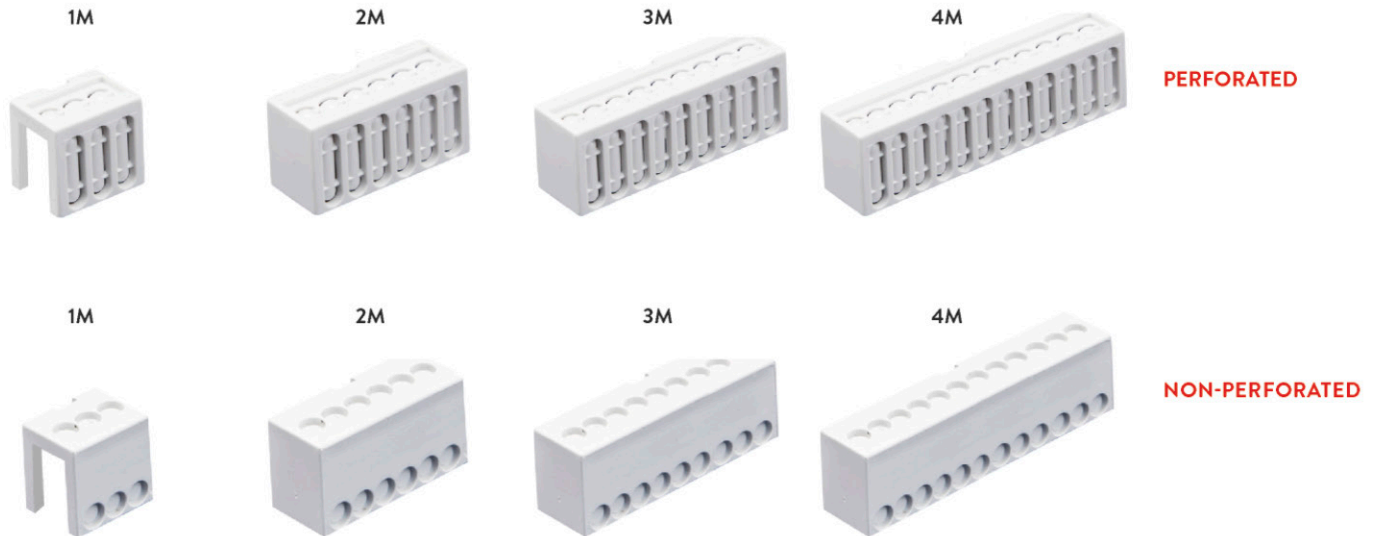

Product Code	Item	Colour	Width (mm)	Length (mm)	Height (mm)
DNMB/1PG	Enclosure 1	Grey	42	14.5	2
DNMB/2PG	Enclosure 2	Grey	42	32	2
DNMB/3PG	Enclosure 3	Grey	42	49.5	2
DNMB/4PG	Enclosure 4	Grey	42	67	2

SLOTTED TERMINAL COVERS



Product Code	Item	Enclosure Height	Colour	Width (mm)	Length (mm)	Height (mm)
DNMB/1TG/5SL	Enclosure 1	60	Grey	13.5	16	17
DNMB/1TG/5SL	Enclosure 1	73	Grey	13.5	16	17
DNMB/2TG/5SL	Enclosure 2	60	Grey	13.5	33	17
DNMB/2TG/5SL	Enclosure 2	73	Grey	13.5	33	17
DNMB/2TG/5SL	Enclosure 2	100	Grey	13.5	33	17
DNMB/3TG/5SL	Enclosure 3	60	Grey	13.5	50.5	17
DNMB/3TG/5SL	Enclosure 3	73	Grey	13.5	50.5	17
DNMB/4TG/5SL	Enclosure 4	60	Grey	13.5	68	17
DNMB/4TG/5SL	Enclosure 4	73	Grey	13.5	68	17

DNMB/HP HOLE PUNCH

- This item is specially made for knocking holes through in the perforated and non-perforated terminal covers.
- It is made from quality steel and has a blue plastic sleeve enabling a firm grip.

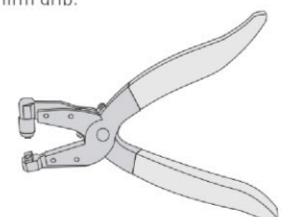

PCB ENCLOSURES AND DIN RAIL SUPPORTS

DIN RAIL SUPPORTS

DIN RAIL 72MM SUPPORTS

Features:

- Suitable for 72mm width PCB's
- Modular construction for easy assembly
- Snap-fit DIN Rail mounting fixtures
- Flame retardant green Polyamide 66 UL 94V0 moulding
- Terminal blocks available in same colour
- Integral marker facility
- Registered Design No: 2106418®
- Also available in different colours

The table below shows the minimum number of parts required to mount PCB's of length of 20mm to 177.5mm to rails. For longer PCB's add additional base elements as required.

Actual usage depends on the total length and, to an extent, weight of the assembled PCB. Additional feet may be required. Side elements with integrated feet are only for top hat rail. The separate feet (DIME/M/FE0000SS) fit both G and top hat rail and can be used with both styles of end section.

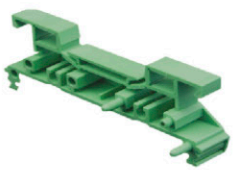
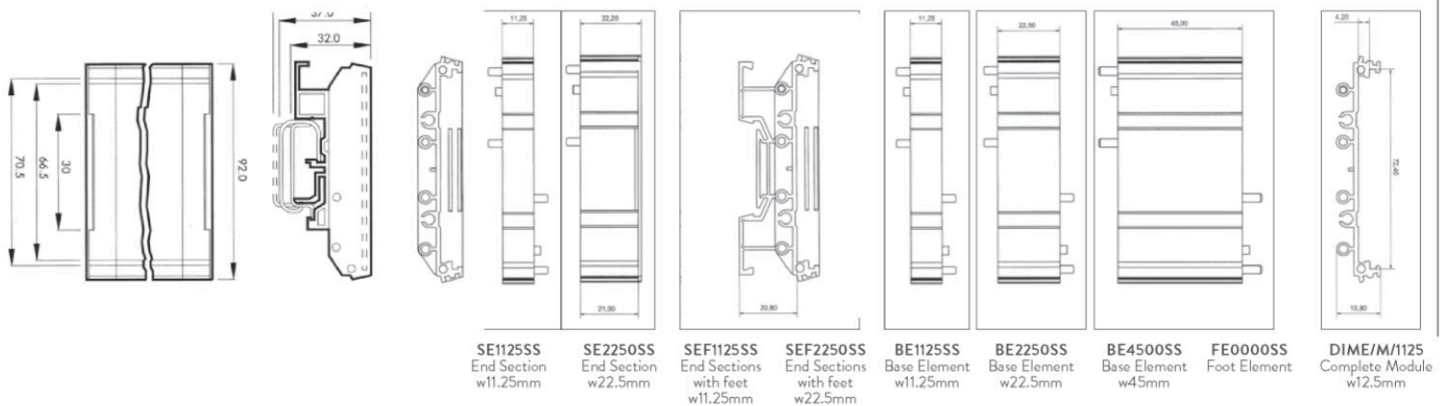

DIME/M/ PCB Length	SE1225SS	SEF1225SS	SEF1125SS	SEF2250SS	BE1125SS	BE2250SS	BE4500SS	Total PCB MM Length	Number of parts
			10	21.25	11.25	22.5	45		
		2						20.00	2
		1	1					31.25	2
			2					42.50	2
			2	1				53.75	3
			2		1			65.00	3
		1	1				1	76.25	3
			2				1	87.50	3
			2	1			1	98.25	4
		1	1				2	121.25	4
			2				2	132.50	4
			2	1			2	143.75	5
			2		1		2	155.00	5
		1	1				3	166.25	5
			2				3	177.50	5



RAILWAY CERTIFIED IP68 CABLE GLANDS

(SEE PAGE 38 FOR FURTHER DETAILS)

- Exceed most standard certifications.
- Meets requirements of the rail industry.
- Specialised flame proof polyamide (PA6).
- Fire class V0 according to UL94.

- Metric and Pg thread.
- Grey or Black.



HALO

TRAINING THE NEXT GENERATION



• **SPECIAL OFFERS**

• **FREE WORKSHOPS**

• **FREE PRODUCT SAMPLES**

HALO supports tomorrow's professional installers by providing the tools they need for the future.
Book yourself on the next practical workshop by scanning, calling or visiting the website below.

TO FIND OUT MORE CALL **01933 234 400**
OR VISIT: www.hylec-halo.com



SCAN TO FIND OUT MORE

RAL COLOUR CHART

 <p>Rape Yellow RAL 1021</p>	 <p>Pastel Orange RAL 2003</p>	 <p>Flame Red RAL 3000</p>
 <p>Traffic Red RAL 3020</p>	 <p>Brilliant Blue RAL 5007</p>	 <p>Sky Blue RAL 5015</p>
 <p>Opal Green RAL 6026</p>	 <p>Silver Grey RAL 7001</p>	 <p>Pebble Grey RAL 7032</p>
 <p>Light Grey RAL 7035</p>	 <p>Platinum Grey RAL 7036</p>	 <p>Dusty Grey RAL 7037</p>
 <p>Agate Grey RAL 7038</p>	 <p>Signal Black RAL 9004</p>	 <p>Jet Black RAL 9005</p>

Pure White RAL 9010

Unless otherwise agreed in writing by the Seller all goods are supplied in the following terms and conditions to the exclusion of any terms and conditions stipulated by the Buyer and any previous representations, warranties or communications not expressly incorporated herein.

1. DEFINITION

"Seller" means Hylec-APL Limited.

"Buyer" means any person, firm or company who place an order for the supply or manufacture of goods with the Seller "Goods" means the articles, items or materials described in the order.

"Order" means the order placed by the Buyer of the goods.

2. FORMATION OF CONTRACT

Quotations unless previously withdrawn, shall be valid for a period not exceeding sixty days from date of tender. No order shall be deemed accepted until the sellers written acknowledgement thereto has been made and subject only to the terms and conditions stated below. Any stipulations or conditions in the Buyers order form which would conflict with these conditions or in any way qualify or negate the same shall be deemed to be inapplicable to the order placed with the Seller unless expressly agreed to by the Seller in writing when acknowledging the order in question.

3. VARIATIONS OF CONDITIONS

Unless otherwise agreed in writing by the Seller the goods are supplied by the Seller only on these conditions and no variation of or addition thereto (whether contained in any document emanating from the Buyer or made orally by any person acting or purporting to act on behalf of the Seller) shall have effect unless it is in writing signed by or on behalf of the Seller. Should any of these conditions conflict with any conditions stated in the Buyers order, these conditions shall prevail.

4. NEW ACCOUNTS

Credit accounts cannot be opened under the minimum amount in operation at the time of placing the order Customers wishing to open a credit account must complete the Seller's standard account application form which is subject to the Sellers acceptance.

5. ACCEPTANCE OF ORDERS

All orders must contain sufficient information to enable the Seller to supply and or manufacture the goods required but no order shall result in a binding contract of sale unless and until it is accepted by the Seller in writing. No liability can be accepted for incorrectly ordered goods.

6. FACSIMILE/E-MAIL ORDERS

Such orders will be deemed to be binding contracts subject to purchase to the Seller's standard terms and conditions.

7. PRICE VARIATIONS

The Seller shall be entitled to adjust the selling price of the goods whether before or after the making of the agreement in which these conditions relate in the event of any variation in the cost to the Seller of supplying the goods or any part thereof, caused by any reason whatsoever beyond the control of the Seller including (without prejudice to the generality of the foregoing) changes in exchange rates or the action of any government or authority. Any increase in delivery charges imposed by the Seller after the date of confirmation of order shall be for the account of the Buyer. The minimum charge in operation at the time of placing the order must be accepted.

8. PASSING OF PROPERTY

The property in the goods shall, not withstanding delivery to the Buyer, remain in the Seller until the Buyer has paid the full price as well as all other sums whatsoever, due to the Seller. If at any time payment of the price or any other sums due to the Seller is overdue, the Seller may by its servants or agents enter upon the Buyer's premises and recover and dispose of the goods and the Buyer shall make no claim against the Seller in respect of such entry or disposal.

9. PASSING OF RISK

The risk in goods supplied overland shall pass to the Buyer on delivery to the Buyer's designated premises or to the carrier nominated by him (whichever

shall first occur) The risk in goods supplied by sea or air transport shall pass to the Buyer on delivery to the earner nominated by the Buyer in which case the Seller will at the Buyer's written request, cost and risk, arrange for the Buyer's express instructions as to transit and packaging for sea or air transport to be carried out.

10. DELIVERY BY INSTALMENTS

If any order for goods to be delivered by several instalments to the Buyer each such instalment shall be treated as a separate and identifiable contract and the rights of either party thereunder shall be construed accordingly, save only that the Seller may suspend delivery thereof whilst payment is overdue in respect of any previous instalment. If the Seller shall fail to make delivery or shall make defective delivery of any instalment such failure or defective delivery shall not affect the obligations of the parties under the contract of which these conditions form part in respect of the other instalments.

11. CARRIAGE AND PACKING

In all mainland areas of England, Scotland and Wales via the Seller's nominated carrier, carriage & packing is not included in the cost unless otherwise specified in writing. Express or Special Delivery at the Buyer's request will always be at the Buyer's expense. Prices do not include VAT which is chargeable on transport and post. For export all packing and delivery charges on goods will be charged at cost and by method designated by the Seller.

12. NON-DELIVERY/LOSS/DAMAGE/DEFECT

The seller shall be notified in writing of the non-receipt of any goods by the Buyer or his nominated carrier within fourteen days of the invoice date, failing which the Seller shall be under no liability whatsoever to the Buyer, who shall nevertheless hold the Seller indemnified against any loss arising or damage suffered through the failure to inform the carriers or the insurer's within the required time limits. The Buyer must notify the Seller of any alleged quantity shortfall, defect in, or damage to the goods within fourteen days of actual receipt and thereafter shall be deemed to have accepted the goods in all respects. Any such notice must specify the particular defect and must afford the Seller reasonable opportunity to inspect the goods in question. If the goods are agreed by the Seller to be defective or faulty the seller will (at its option) either rectify the defect or fault or replace any such goods or credit the invoice value of the goods and such rectification or replacement or credit will be in full satisfaction of any claim by the Buyer.

13. CONSEQUENTIAL LOSS

The Seller shall be under no liability whatsoever (including without prejudice to the generality of the foregoing any liability in tort or for consequential loss or damage of any kind) for breakage or resulting defect occurring after delivery for any defect in or failure of or unsuitability for any purpose of the goods or any part thereof whether the same be due to any act omission negligence or wilful default of the Seller or its servants or agents or to faulty design, workmanship or material or any other cause whatsoever, including (without prejudice to the generality of the foregoing) any breach by the Seller, its servants or agents of any fundamental term or any fundamental breach by the Seller, its servants or agents of any term of the contract of which these conditions form part; and all other conditions, warranties or other terms whether express or implied, statutory or otherwise inconsistent with the provisions of these conditions are hereby expressly excluded.

14. PENALTY CLAUSES

Penalty clauses on Buyers orders or contracts cannot be accepted unless a specific undertaking in writing is secured from the Seller covering each order or contract concerned. Such an undertaking will not be regarded as valid unless signed by a Director of the Seller.

15. FORCE MAJEURE

The Seller shall do all in its power to perform the terms of any contract of which these conditions form part and in particular to meet all delivery dates but shall not be liable for any failure to observe or breach of any of the terms hereof by reasons or acts of God, war, riots, civil commotions, strikes, lock-outs, trade disputes, fires, breakdowns, interruptions of transport, Governmental action delay in delivery by the Seller's suppliers or any other cause.

16. RETURNS

Goods supplied correctly to the order of the Buyer can be returned only if the Seller's permission is first obtained. Permission will only be considered if the goods are those which the Seller regularly carries in stock. All returns are subject to a handling charge.

17. QUANTITIES

The price quoted is for stipulated quantities only and must not be taken to apply to any order for any lesser quantities. All quotations for goods to be delivered from stock are subject to these goods being unsold on receipt of order.

18. COLOUR

Colour shall be subject to reasonable variation.

19. SAMPLES

Any samples or shade cards supplied to the Buyer shall be accepted by the Buyer as supplied solely for information and as in no way importing any express or implied conditions or warranties as to quality, description, colour, fitness or merchantable quality of goods subsequently delivered and the Buyer shall be deemed to have satisfied himself as to such matters prior to ordering the goods.

20. RECOMMENDATIONS

Whilst all written recommendations including catalogues and advertising matter, made by the Seller as to the performance of the goods are made in good faith and in the belief that they are correct the Seller shall have no responsibility whatsoever for any damage liability cost claim or expense suffered by the Buyer or any third party through following such recommendations.

21. SPECIFICATION ALTERATIONS

The Seller reserves the right to alter the specification of any goods without prior reference to the Buyer provided that the goods comply in all other known respects with the Buyer's requirements.

22. TRADE-MARKS/PATENTS

The supply of goods by the Seller shall not confer any right upon the Buyer to use any Seller's trade-mark without prior written consent of the Seller and at all times such trademark shall remain the property of the Seller. Neither does it imply any right to use any Seller's patent or any indemnity against infringement of third party patents.

23. DELIVERY

Any stipulated time for delivery shall date from receipt by the Seller of the Buyer's written order to proceed or of all the necessary information, drawings and inserts to enable the Seller to put the work in hand, whichever be the later. Delivery dates or periods are given in good faith and the Seller will make every effort to meet them but no liability is accepted for failure to deliver on a specified date or within a specified period.

24. DIMENSIONS

All components supplied by the Seller shall conform as nearly as possible to the dimensions stipulated by the Buyer but deviation therefrom not adversely affecting the products to any material extent shall not affect the contract or entitle the Buyer to cancel the same. Any variation in limits to be subject to special arrangement and agreement in writing prior to acceptance of order. Standard catalogue parts are supplied against the Seller's catalogue specification and not against any drawing specification supplied by the Buyer.

25. INDEMNITY

The Buyer shall indemnify the Seller against all claims in respect of any loss, injury or damage sustained by a third party, however caused, after receipt of the goods by the Buyer and shall also pay and indemnify the Seller against all royalties or other payments in respect of any patents registered designs or other rights which may be claimed as a result of goods being made according to designs or specifications supplied by the Buyer and shall indemnify the Seller against all claims expenses and costs in connection with any infringement or alleged infringement of any patent registered design or other right in the manufacture of such goods.

26. LIABILITY

- (a) The Seller will use his best endeavours to obtain for the Buyer the benefit of any warranty in respect of the goods (including any undertakings to repair or replace defective parts) which the Seller receives from his own suppliers in relation thereto.
- (b) The Seller's liability in terms of these conditions is in lieu and to the exclusion of all other warranties conditions or obligations imposed or implied by statute or otherwise in relation to the quality or description of the goods or their fitness for any particular purpose.
- (c) All liability for consequential or indirect loss or damage howsoever arising is hereby expressly excluded.

27. ASSIGNMENT

The Buyer shall not, without the Seller's prior written consent, assign or transfer or purport to assign or transfer the contract to which these conditions relate or the benefit thereof to any other person whomsoever.

28. INDULGENCE

No indulgence or forbearance extended to the Buyer shall limit or prejudice any right or claim available to the Seller.

29. PAYMENT

- (a) The Buyer shall pay the amount invoiced in accordance with the Seller's payment terms. Nett monthly accounts are payable by the end of the month following month of invoice unless otherwise agreed in writing.
- (b) If the Buyer fails to make payment by the due date, then without prejudice to any other right or remedy available to the Seller, the Seller shall be entitled to:
 - (i) Suspend any further deliveries to the Buyer until payment in full is made.
 - (ii) Appropriate any payments made by the Buyer to such of goods (or the goods supplied under any other contract between the Buyer and the Seller) as the seller may see fit (notwithstanding any purported appropriation by the Buyer), and
 - (iii) Charge the Buyer interest (both before and after any Judgement) on the amount unpaid at the rate of four percent (4%) per annum above the Barclays Bank Plc base rate from time to time until payment in full is made (a part of the month being treated as a full month for the purpose of calculating interest.)

30. CANCELLATION

- (a) If the Buyer shall fail to make any payment when it becomes due or shall enter into any composition or arrangement with its creditors or if being an incorporated company shall have a receiver appointed or shall pass a resolution for winding up or a Court shall make an order to that effect or if not being an incorporated company shall have a receiving order made against it or if there shall be any breach by the Buyer of any of the terms and conditions hereof, the Seller may defer or cancel any further deliveries and treat the control of which these conditions form part as determined but without prejudice to its right to any unpaid purchase price of goods delivered and to damages for any loss suffered in consequence thereof.
- (b) Orders are not subject to cancellation, change, reduction in amount or suspension of deliveries except with Seller's consent and upon terms which protect the Seller from loss.

31. CERTIFICATES OF CONFORMITY

Certificates of Conformity can be issued on request at a cost stipulated by the Seller at the time of order.

32. ARBITRATION

If at any time any question, dispute or difference whatsoever shall arise between the Buyer and the Seller upon or in relation to or in connection with the contract, either party shall give to the other notice in writing of such question whatsoever beyond its control, the time for delivery shall be extended until such cause shall have ceased to operate.