

50.620 M/EMVDL

Perfect cable gland EMVD M20X1,5 thread length 10, min/max cable dia 9-13

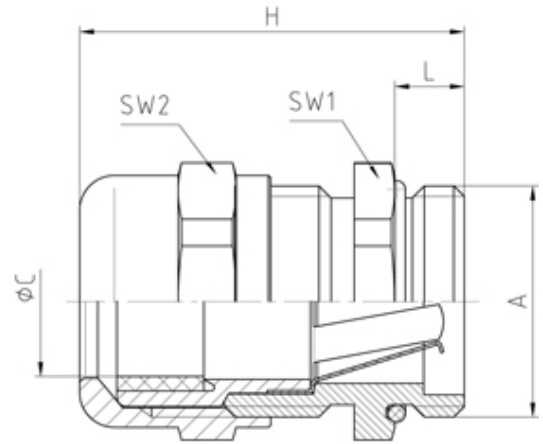

SPECIFICATION

Product Type	EMVD/EMCD
Sealing Ring Material	Polychloroprene-Nitrile rubber CR/NBR
Body Material	Nickel Plated Brass
Min Temperature °C	-20
Max Temperature °C	100
IP Rating	68
Thread Size	M20
Clamping Range Min (mm)	9
Clamping Range Max (mm)	13
Lamellar Insert Material	Polyamide PA6 V-2
External Connecting Thread Type	Metric
Thread Length (mm)	10
Contact Spring Material	Stainless steel
Comments	details about tests - see annex
Width Across Flat 1 (mm)	22
Width Across Flat 2 (mm)	22
Height (mm)	37.5
Connecting Thread Size	M20x1.5
Additional Material Detail	Body - Brass CuZn39Pb3 nickel plated, O-Ring - Nitrile rubber
Standards	UL514B

DISTRIBUTORS

