

TL002V-03PGS

3 Pole Vertical PCB terminal block 3.5mm pitch 10A 300V

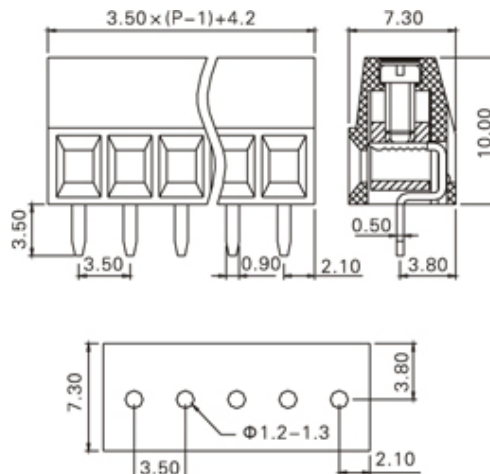
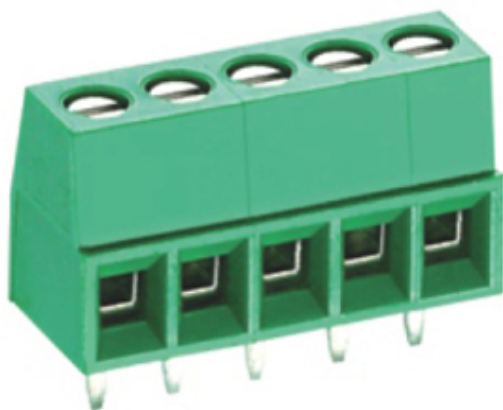

SPECIFICATION

Type	Screw
Connection Method	Rising Clamp
Mounting Type	Wave - through hole
Orientation	Vertical
Join	Interlocking
Pitch (mm)	3.5
Number of Poles	3
Min Wire Size (Sq mm)	0.12
Max Wire Size (Sq mm)	1.5
Max Current (A)	10
Max Voltage (V)	300
Height (mm)	10
Standard Colour	Green
Width (mm)	7.3
Length (mm)	11.2
Solder Pin Length (mm)	3.5
PCB Hole Diameter (mm)	1.2-1.3
Body Material	PA66 V0
Comments	Pole sizes / no of ways not shown, please contact us for availability
Max Temp Rating °C	105
Max Wire Size AWG	-40
Minimum Temp Rating °C	16
Min Wire Size AWG	26