

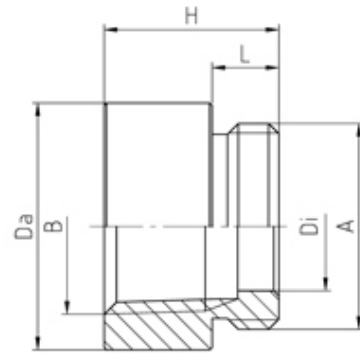

Metric/NPT Adapters

Range: Cable Glands/Grommets

Order Code: M32NPT3/4



DESCRIPTION

Adapter M32/NPT3/4 thread length 8 M32x1.5 Body - Brass CuZn39Pb3 nickel plated

*Subject to technical modification without notice.
Typographical and other errors do not justify claim for damages.*

SPECIFICATION

Product Type	Standard
Body Material	Nickel Plated Brass
Max Temperature Rating °C	200
IP Rating	dependent on the combination with other components
Hole Diameter (mm)	23
Thread Size	M32-NPT 3/4
External Connecting Thread Type	NPT 3/4"
Internal Connecting Thread Type	NPT
Thread Length (mm)	8
External Diameter (mm)	37
Height (mm)	26
Connecting Thread Size	M32x1.5
Additional Material Detail	Body - Brass CuZn39Pb3 nickel plated